

CE30-A Solid State Array LiDAR Specification

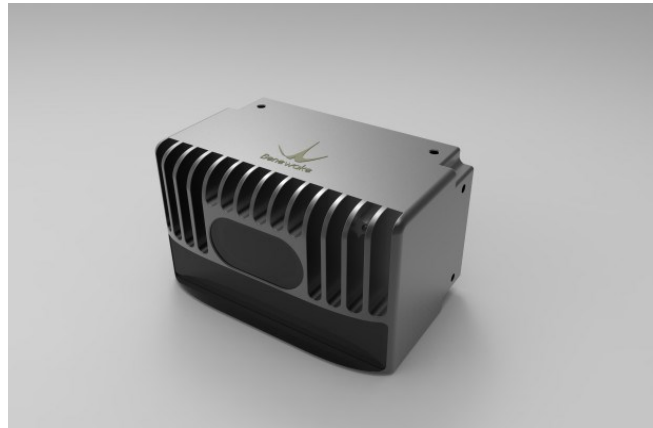

Benewake (Beijing) Co., Ltd.



Table of Contents

1. Product Overview.....	3
2. Principle of Ranging	4
3. Description of Obstacle Avoidance Mode.....	6
3.1. Obstacle Avoidance Mode.....	6
3.2. Setting Warning Region in Obstacle Avoidance Mode	7
4. Communication Protocol	8
4.1. CAN Bus (Obstacle Avoidance Mode).....	8
4.2. Ethernet (TCP/IP).....	10
5. Product Dimensions	10
6. Aerial Socket Interface Description	10
7. Package & Accessories	11

1. Product Overview

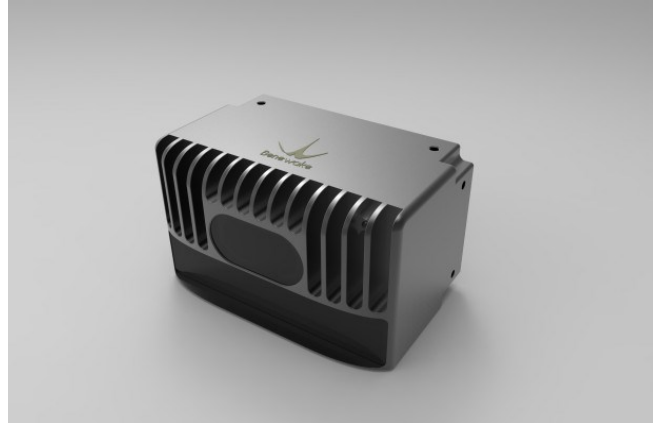

Figure 1 CE30-A

Characteristics

- Complete solid-state design
- Area-array detection
- Horizontal FOV > 120°
- Vertical FOV 9°
- ROI setting for obstacle avoidance mode
- Embedded algorithm: nearest obstacle calculation, transferred by CAN BUS

Table 1 CE30-A Specification

Parameter ¹	Typical Value
Method	Time of flight
Peak Wavelength	850nm
FOV ²	132*9 degree
Pixel Resolution	320*24
Frame Rate	20fps
Ranging Resolution	1cm
Detecting Range ³	0.1~4m

¹Specific parameters may differ due to the testing environments and the test modes. When the LiDAR is running for 20 mins, a whiteboard with reflectivity 90% is used in the following as default, and the data obtained from the central pixels are used for evaluation.

²The detection can be customized.

Repeatability (1σ)	$\leq 3\text{cm}$
Accuracy	$\leq 6\text{cm}$
Ambient Light Resistance⁴	60klux
Data Interface	CAN
Operating Temperature	0~50°C
Storage Temperature	-30~70°C
Supply Voltage	DC 12 \pm V ($\geq 2\text{A}$)
Power Consumption	$\leq 6\text{W}$
Dimensions	79*47*50mm
Enclosure Rating	IP65
Eye Safety Class	EN 62471 Exempt
Weight	219g

2. Principle of Ranging

The ranging principle of CE30-A is based on Time of Flight (TOF). CE30-A emits modulated near-infrared light, which will be reflected by the object and received by CE30-A again. CE30-A calculates the phase difference and the time difference between the emitted and received light, which will be further converted to the distance of the obstacle.

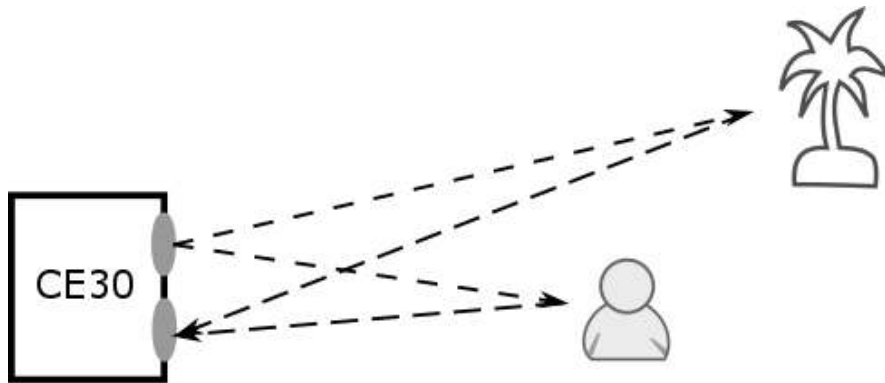

Figure 2 Schematic of the detecting principle

³The result is based on the whiteboard with reflectivity 90%. The detection range of the blackboard with reflectivity 10% is around 1.5m. Different angles also lead to different maximum detection range. For details, please refer to Principle of Ranging.

⁴ In strong ambient light, the accuracy may be reduced. Please refer to the manual for more details.

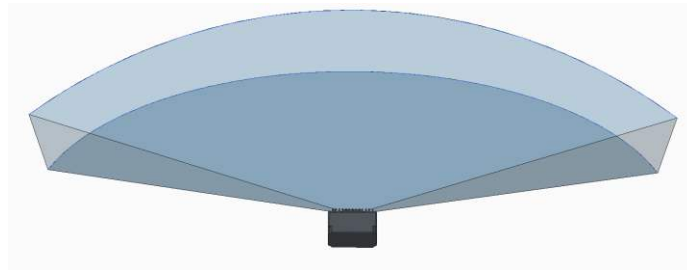

Figure 3 Illustration of CE30-A detection area. Compared with single-channel LiDAR, CE30-A has a wider vertical FOV.

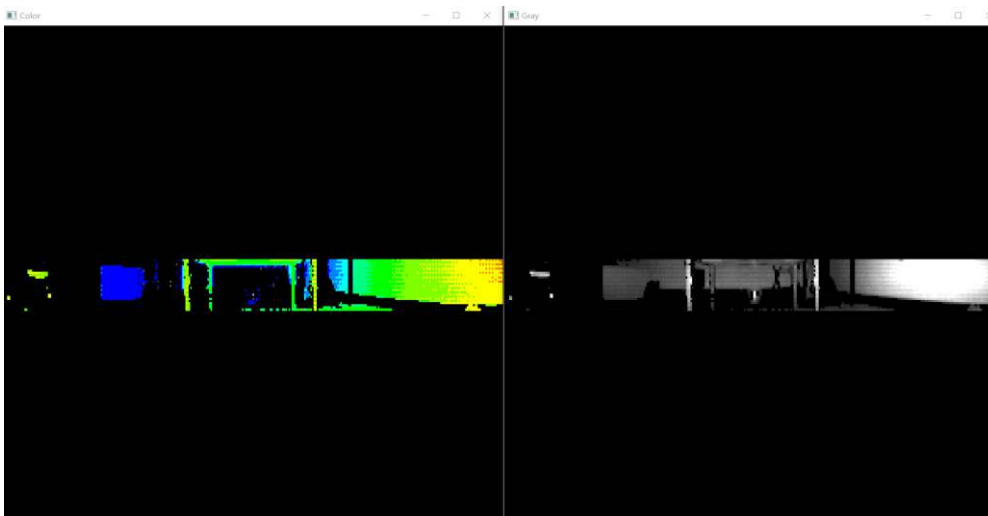

Figure 4 A real detected scene. Depth image (left) and corresponding grey image (right). In practical use, some cylindrical objects can be clearly captured (such as table leg).

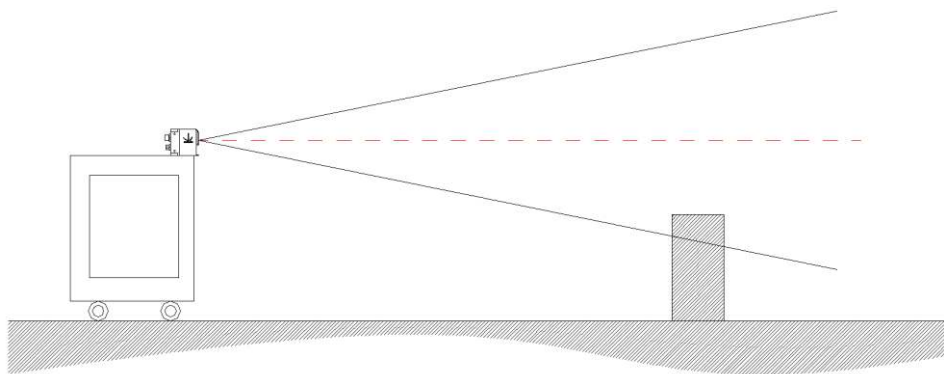

Figure 5 Application in the obstacle avoidance mode. Compared with the 2D Scanning LiDAR (the red line), CE30-A can detect obstacles lower than the mounting height.

CE30-A captures the distance information of all the obstacles within the detecting range and the FOV. The detecting area is shown in Figure 6.



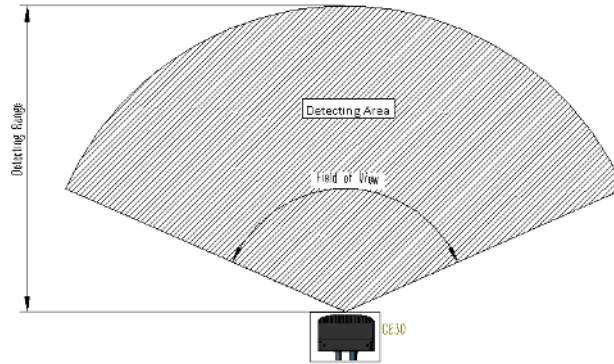

Figure 6 Illustration of Detecting Range and Area

The farthest detecting range of each angle has been optimized for general obstacle avoidance scenarios, which are different from regular detecting range. The schematic diagram is shown in Figure 6 (Customization is available for special requirements).

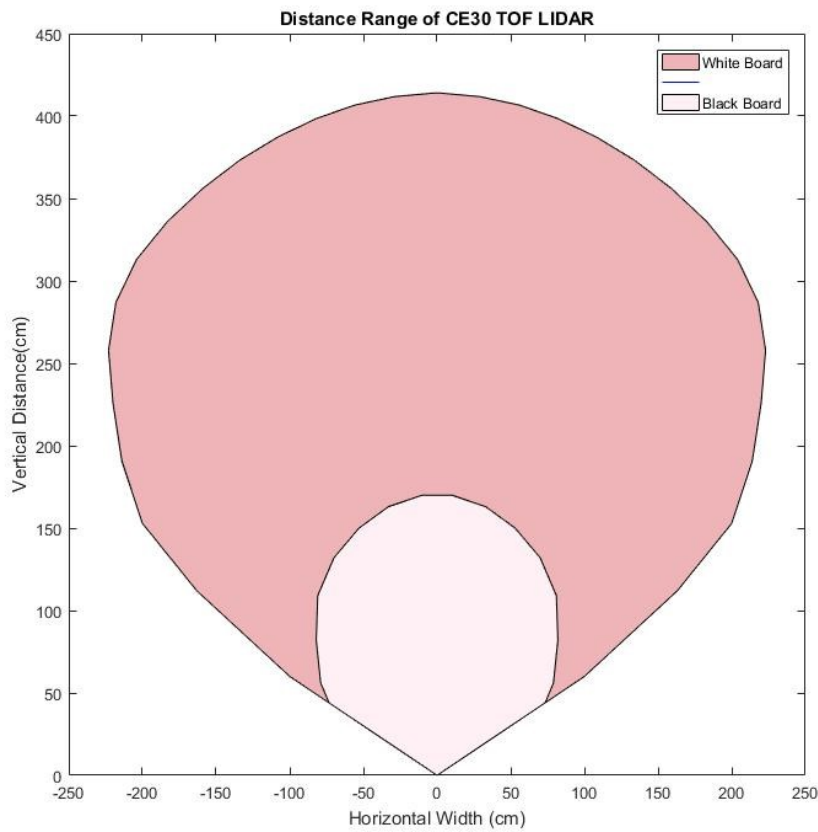

Figure 7 Optimized Detecting Area for Obstacle Avoidance Application

3. Description of Obstacle Avoidance Mode

3.1. Obstacle Avoidance Mode

The obstacle avoidance mode of CE30-A is especially developed for the application of robot's obstacle avoidance. In this mode, CE30-A will select the most critical obstacle and upload the distance information to the robots.



The principle of the obstacle selection is as follows: CE30-A selects the nearest obstacle to LiDAR. Then it gathers detecting and computing resources, to calculate the azimuth and the projected distance of the obstacle more precisely.

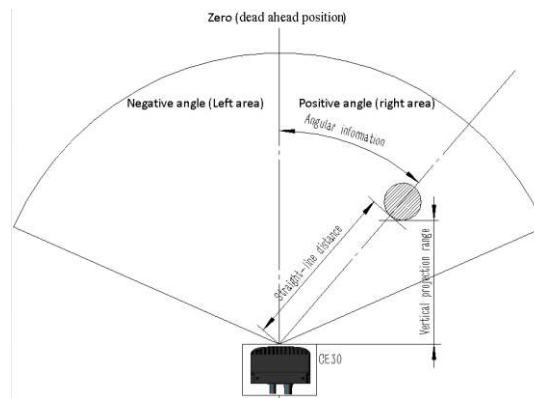

Figure 8 Testing Data Illustration (Top View)

Among them, azimuth represents the angular deviation between the obstacle and the central line of the LiDAR's HFOV (0 for central line, negative for left and positive for right) and the degree of trajectory deflection required to avoid the obstacle.

Projected distance represents the projected distance from the obstacle to the robot (the robot is square at default and LiDAR is installed on the front surface of the robot). It also indicates the emergence level of avoiding the obstacle.

3.2. Setting Warning Region in Obstacle Avoidance Mode

In many cases, not all objectives within the FOV worth the warning or the response of obstacle avoidance. The warning region can be set up in the obstacle avoidance mode. Once it is set up, though the detection range is the same, only the information of the obstacles in the warning region will be reported to the robot.

We could set the region of interest (ROI) by the width and depth:

- 1) Width: the width of a LiDAR-centered area extending symmetrically. It's usually the same as that of the robot, i.e. the width of the robot in the direction of forward motion.
- 2) Depth: the projected distance to the LiDAR, for which the front surface of LiDAR is set to be the zero plane. Usually, it corresponds to the distance that the robot needs to make brake in response to obstacles.

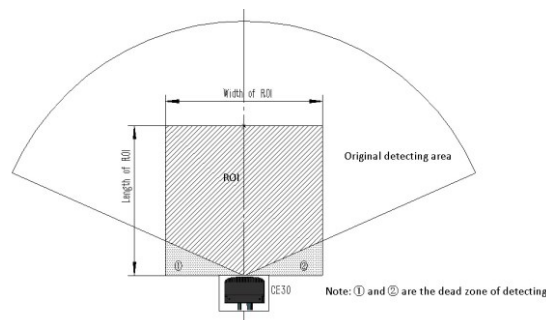

Figure 9 Schematic Diagram of ROI Function Description

In the obstacle avoidance mode with ROI setting, CE30-A will preferentially trace the obstacles in the ROI. For example, Objective A inside the ROI and Objective B outside the ROI exist simultaneously. Even though Objective B is nearer to CE30-A than Objective A, CE30-A still returns the information of Objective A rather than Objective B, as shown in Figure 10.

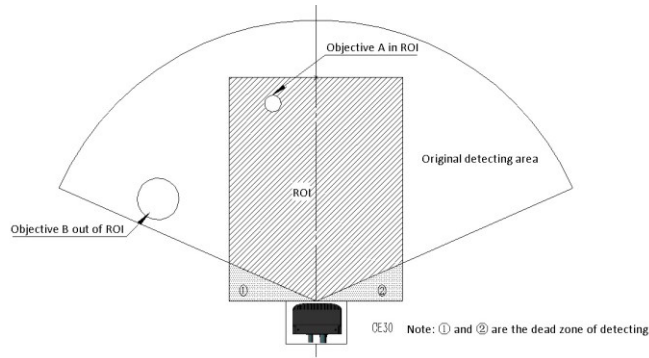

Figure 10 Schematic of ROI Function Determination

4. Communication Protocol

The following sections describe the communication protocol between CE30-A and external devices. The interface supports Ethernet/TCP protocol and CAN bus. Currently only the CAN bus protocol is available for the obstacle avoidance mode.

4.1. CAN Bus (Obstacle Avoidance Mode)

CE30-A uses CAN standard frame, with baud rate 250kbps.

4.1.1. CAN Command Frame Format

Table 2 CAN Command Frame Format

MPU-->CE30-A	Byte length	Description
ID:0x606		
Start command	1	bit7-6:11 bit5-1:00000 bit0: 1 - Start ranging and sampling 0 - Stop ranging and sampling
Spare	1	0x00
Width	1	Unit: cm. 0: no width limit
Depth	1	Unit: dm. 0: no depth limit
Version number inquiry	1	0xaa 0x5a, 1: central calibration. The command should be operated in the stop mode. Please refer to the manual for more details. (In the stop mode, the command takes effect and ignores start/stop and the ROI setting; in the

		operation mode, the command does not take effect and the machine will be restored to the state before center calibration.)
--	--	---

- 1) Depth is the ROI length of the test distance, in dm;
- 2) Width is the ROI width of the test distance, in cm;
- 3) The Spare field is temporarily reserved.

4.1.2. Data Frame Format

Table 3 CAN Data Frame Format

CE30-A-->MPU	Data length	Description
ID:0x586		
The projected distance of nearest obstacle point	2	Little-endian. Unit: cm
Reserve	1	
The angle of the nearest obstacle point	1	Degree
Reserve	3	
State	1	bit0: 1-obstacle detected, 0-no obstacle

- 1) The data provided by the LiDAR is the projected distance of the obstacle to the front surface of the machine, and the angle of the nearest point of the obstacle, i.e. (z, θ). The center of the FOV is 0 degree, the left is negative and the right is the positive. See Figure 6.
- 2) Distance data is 2byte, and transmitted by the means of little-endian, in cm.
- 3) All angle values are signed 8 bit angle values, in degree.

4.1.3. Heartbeat Frame Format

Table 4 Heartbeat Information

CE30-A-->CPU	Byte length	Description
ID:0x587		
Heartbeat packet	1	bit0: 1 – Running state; 0 – Stop state bit1: 1 – Valid version number; 0 - Invalid version number bit2: 1 – Error; 0 – Normal;



		bit3: reserve bit4: 1 – Center calibrated; 0 – Without center calibration; bit5_7: Heartbeat value (From 0 to 7 in turn)
Version number	2	Version number

The time interval of the heartbeat packet is 150ms. If there is a version inquiry, the heartbeat packet (including the version number) will respond immediately.

4.2. Ethernet (TCP/IP)

Please refer to the data sheet of CE30-C.

5. Product Dimensions

Dimensions and installation instruction (customizable configuration structure)

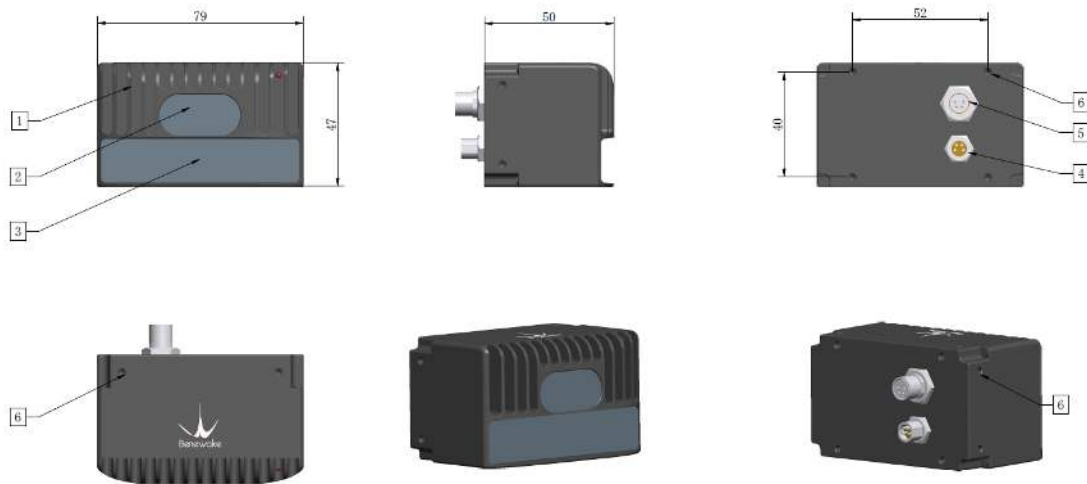

1. Shell
2. Receiving panel (working area, no coving)
3. Sending panel (working area, no coving)
4. Power supply/CANBUS (M8 aerial socket)
5. Ethernet port (M8 aerial socket)
6. Equipment installing hole (M3)

Figure 11 Structure and Dimension of DELiDAR CE30-A

6. Aerial Socket Interface Description

Female: Ethernet connector - aerial socket with 8 mm diameter.

Male: Power supply/CANBUS connector - aerial socket with 8 mm diameter.

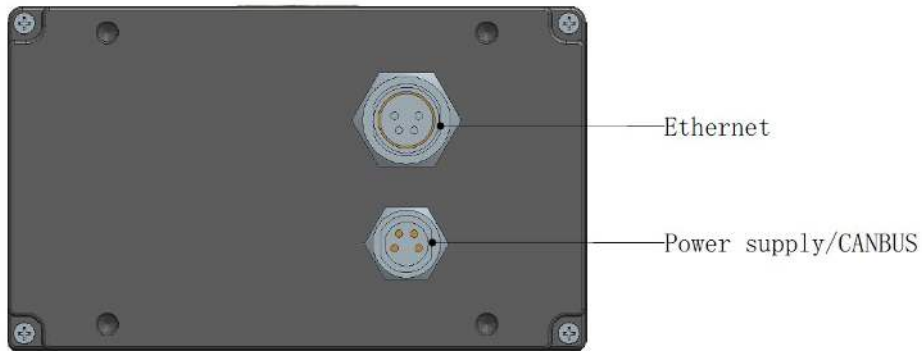

Figure 12 CE30-A Aerial Connection Description

Power supply/CANBUS	Pin number	Explanation
	1	CAN_L
	2	CAN_H
	3	GND
	4	12V +

Figure 13 Power Supply/CANBUS Socket Pin Definition



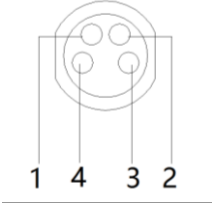

Ethernet	Pin number	Explanation
	1	ETH_RX_P
	2	ETH_RX_N
	3	ETH_TX_P
	4	ETH_TX_N

Figure 14 Ethernet Socket Pin Definition

7. Package & Accessories

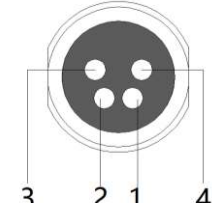
Accessories	Image	Remark
Aerial Connection – Power Supply&CANBUS		Power supply and CAN protocol
Aerial Connection – Ethernet (optional)		TCP protocol

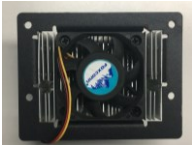

<p>Thermal Dissipation module (optional)</p>		<p>Support and Thermal Dissipation</p>
<p>Demonstration Kit (optional)</p>		<p>Windows Demonstration Kit (Windows 7/10 64)</p>

