

TYPICAL SWITCH ORDERING EXAMPLE

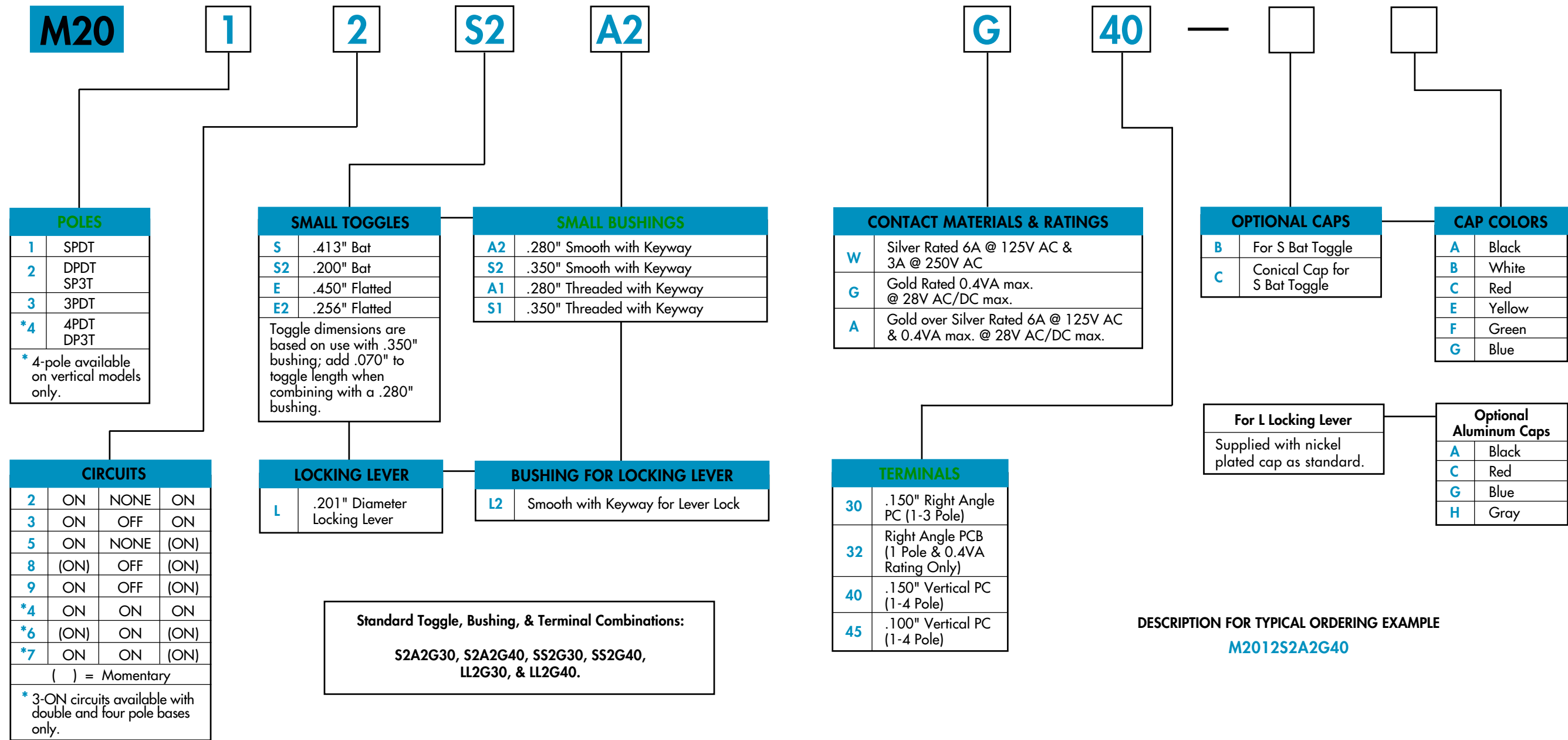

IMPORTANT:

Switches are supplied without UL & CSA marking unless specified. Specific models & ratings noted on General Specifications page.

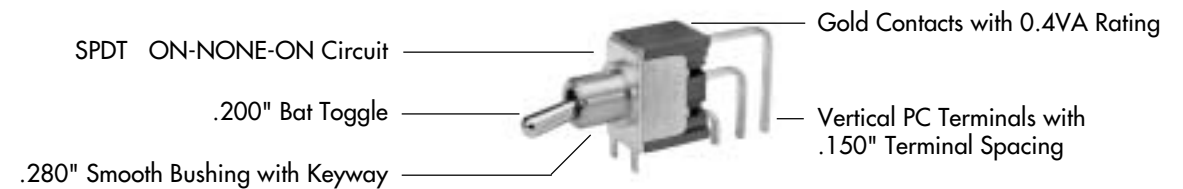

GENERAL SPECIFICATIONS

Electrical Capacity (Resistive Load)

- Power Level (code W):** 6A @ 125V AC & 3A @ 250V AC or
4A @ 30V DC for On-None-On; 3A @ 30V DC for all other circuits
- Logic Level (code G):** 0.4VA maximum @ 28V AC/DC maximum
- Logic/Power Level (code A):** Combines W & G ratings
- Note: See Supplement Index (page Z1) to find explanation of dual rating and operating range.

Other Ratings

- Contact Resistance:** 10 milliohms maximum for silver; 20 milliohms maximum for gold
- Insulation Resistance:** 1,000 megohms minimum @ 500V DC
- Dielectric Strength:** 1,000V AC minimum between contacts; 1,500V AC minimum between contacts and case
- Mechanical Life:** 100,000 operations minimum;
50,000 operations minimum for flat, locking, & splashproof devices
- Electrical Life:** 25,000 operations minimum for silver; 50,000 operations minimum for gold;
50,000 operations minimum for silver at 3A @ 125V AC
- Nominal Operating Force:** 400 grams for Single Pole 450 grams for Double Pole
700 grams for Three Pole 800 grams for Four Pole
- Angle of Throw:** 25°

Materials & Finishes

- Toggle:** Brass with chrome plating
- Bushing:** Brass with nickel plating
- Frame:** Stainless steel
- Support Bracket:** Stainless steel with tin-lead plating
- Case:** Diallyl phthalate resin
- Movable Contact:** Phosphor bronze with silver or gold plating
- Movable Contacts:** Silver alloy (code W); copper with gold plating over nickel plating (code G); or
silver alloy with gold plating over nickel plating (code A)
- Stationary Contacts:** Silver with silver plating (code W); copper or brass with gold plating
over nickel plating (code G); or silver with gold plating over nickel plating (code A)
- Terminals:** Copper or brass with silver plating; or copper or brass with gold plating over nickel

Environmental Data

- Operating Temp Range:** -30°C through +85°C (-22°F through +185°F)
- Humidity:** 90 ~ 95% humidity for 96 hours @ 40°C (104°F)
- Vibration:** 10 ~ 55Hz with peak-to-peak amplitude of 1.5mm traversing the frequency range
& returning in 1 minute; 3 right angled directions for 2 hours
- Shock:** 50g acceleration (tested in 6 right angled directions, with 5 shocks in each direction)







Installation

- Mounting Torque:** 15kgf/cm (13lb/in) for double nut; 7kgf/cm (6lb/in) for single nut
- Soldering Time & Temperature:** 3 seconds @ 350°C or 5 seconds @ 270°C
- Process Seal:** Not available

Standards & Certifications

- Flammability Standards:** UL94V-0 available
- UL Recognized:** All models recognized at 6A @ 125V AC or 3A @ 250V AC or
0.4A maximum @ 28V DC maximum; UL File No. E44145
- CSA Certified:** All models certified at 6A @ 125V AC or 3A @ 250V AC or
0.4VA @ 28V maximum; CSA File No. LR23535

POLES & CIRCUITS

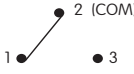
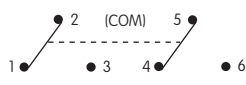
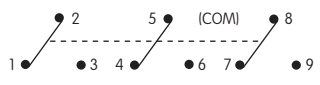
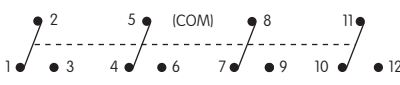
		Toggle Position () = Momentary			Connected Terminals			Throw & Schematics
Pole	Model	Down 	Center 	Up 	Down 	Center 	Up 	Note: Terminal numbers are not actually on the switch. * Reverse circuits available upon request.
SP	M2012 M2013 M2015* M2018 M2019*	ON	NONE	ON	2-3	OPEN	2-1	SPDT 
DP	M2022 M2023 M2025* M2028 M2029*	ON	NONE	ON	2-3 5-6	OPEN	2-1 5-4	DPDT 
3P	M2032 M2033 M2035 M2038 M2039	ON	NONE	ON	2-3 5-6 8-9	OPEN	2-1 5-4 8-7	3PDT 
4P	M2042 M2043 M2045 M2048 M2049	ON	NONE	ON	2-3 5-6 8-9 11-12	OPEN	2-1 5-4 8-7 11-10	4PDT 

For 3 Throw (3-On)

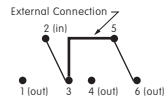
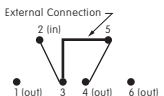
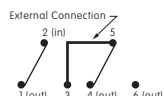
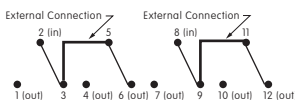
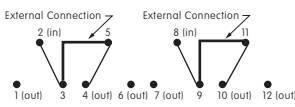
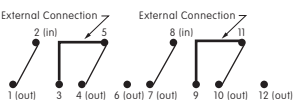
Pole	Model	Down	Center	Up	Connected Terminals & Schematics
SP	M2024 M2026 M2027	ON (ON) ON	ON ON ON	ON (ON) (ON)	   <p>2-3 5-6 2-3 5-4 2-1 5-4</p>
DP	M2044 M2046 M2047	ON (ON) ON	ON ON ON	ON (ON) (ON)	   <p>2-3 5-6 2-3 5-4 2-1 5-4 8-9 11-12 8-9 11-10 8-7 11-10</p>

The SP3T model utilizes a double pole base.

External connection must be made during field installation.

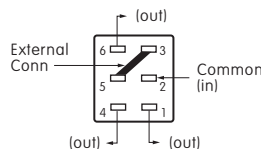

The DP3T model utilizes a double pole base.

External connection must be made during field installation.

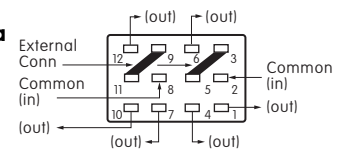

SMALL TOGGLES

Important:

Toggle length changes based on bushing selected. All illustrations are shown with .350" long bushing. When using a .280" long bushing, toggle length increases .070".

Standard Material & Finish:

Brass with Bright Chrome

Optional Finishes:

Contact factory for satin chrome or black.

Other Toggle Options:

Contact factory for other toggle options.

S .413" Bat

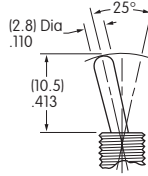

S2 .200" Bat

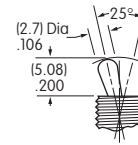

E .450" Flatted

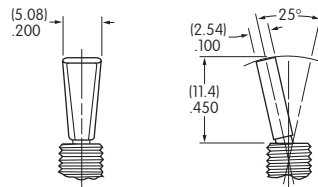

E2 .256" Flatted

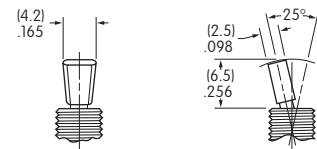

SMALL BUSHINGS

A2 .280" Smooth with Keyway

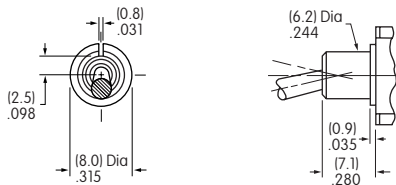

S2 .350" Smooth with Keyway

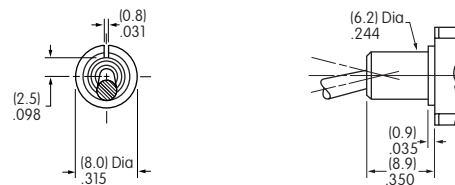

When using this bushing, toggle length is increased by .070".

A1 .280" Threaded with Keyway

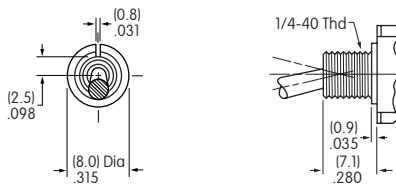

S1 .350" Threaded with Keyway

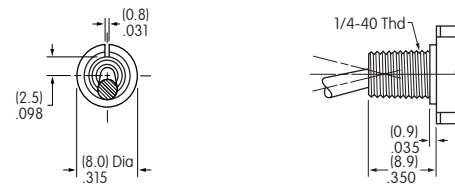

When using this bushing, toggle length is increased by .070".
Max. Panel Thickness w/Standard Hardware: 0.8mm (.031")

Max. Panel Thickness w/Standard Hardware: 2.6mm (.102")

Panel Cutouts

For A2, S2, A1, or S1 Bushing with Keyway

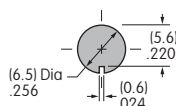

For A1 or S1 Bushing with Locking Ring

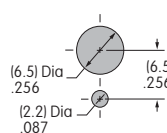

Standard Hardware:

- 2 Hex Nuts (AT513H)
- 1 Lockwasher (AT509)
- 1 Locking Ring (AT507H)

For dimensions, see page Y1.

LOCKING LEVER & BUSHING

LL2 Smooth with Keyway

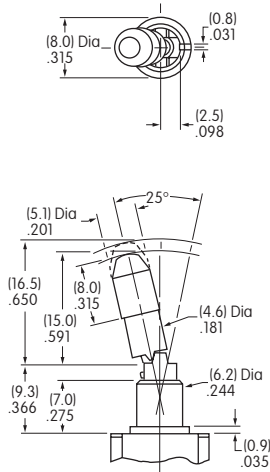

Cap for Locking Lever

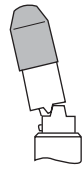

Supplied with Cap AT427
Cap Material:
 Brass with Nickel Plating
Lever Material & Finish:
 Brass with Chrome Plating

Color Codes for Optional Anodized Aluminum Caps

- | | |
|----------------|----------------------------------|
| A Black | C Red |
| G Blue | H Gray (natural aluminum) |

Locking Mechanism

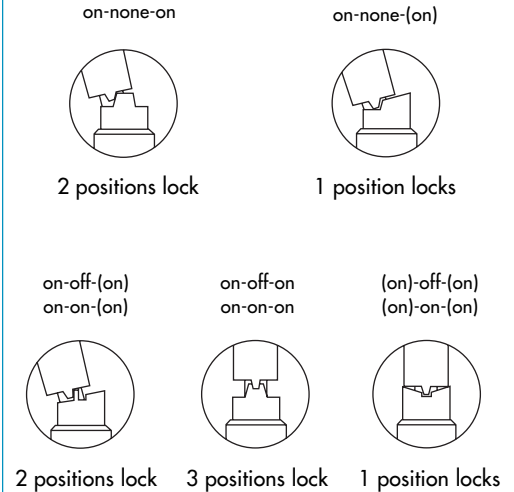

CONTACT MATERIALS & RATINGS

W Silver over Silver Power Level 6A @ 125V AC & 3A @ 250V AC

G Gold over Brass or Copper Logic Level 0.4VA maximum @ 28V AC/DC maximum
 Note: See Supplement Index (page Z1) to find complete explanation of operating range.

A Gold over Silver Power Level or Logic Level 6A @ 125V AC or 0.4VA maximum @ 28V AC/DC maximum

Note: This dual rated option is suitable when two or more identical switches are used in logic and in power circuits within the same application. See Supplement Index (page Z1) to find complete explanation of dual rating and operating range.

TERMINALS

30 .150" Right Angle PC (1-3 Pole)

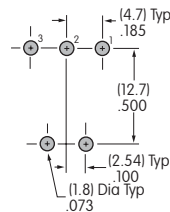
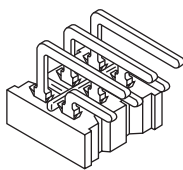

Single Pole

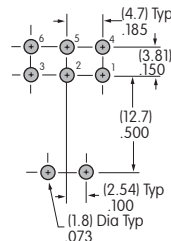

Double Pole

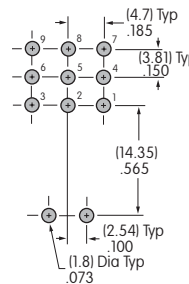

Three Pole

32 Right Angle PCB with Reverse Circuit (1 Pole & 0.4VA Rating Only)

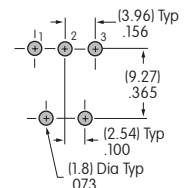
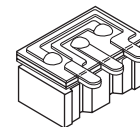

Terminal dimensions are shown on the Typical Switch Dimensions pages which follow.

TERMINALS (Continued)

40 .150" Vertical PC (1-4 Pole)

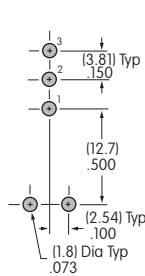
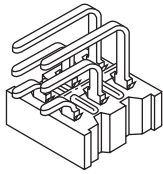

Single Pole

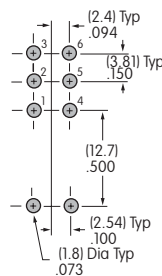

Double Pole

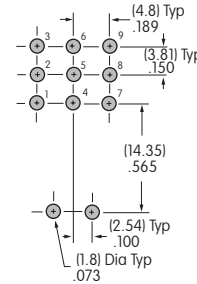

Three Pole

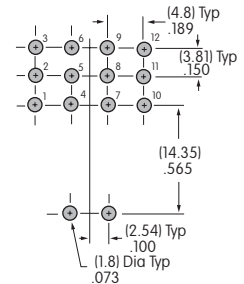

Four Pole

45 .100" Vertical PC (1-4 Pole)

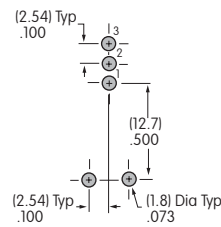
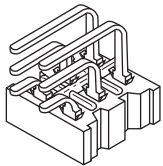

Single Pole

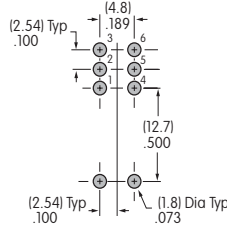

Double Pole

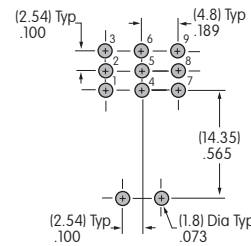

Three Pole

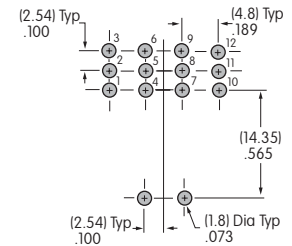

Four Pole

Terminal dimensions are shown on the Typical Switch Dimensions pages which follow.

OPTIONAL CAPS & CAP COLORS

B AT415 For S Bat Toggle

Material: Polyethylene

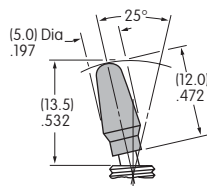

C AT444 Conical Cap for S Bat Toggle

Material: Polyethylene

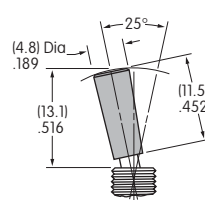

Colors Available

- | | |
|----------------|-----------------|
| A Black | E Yellow |
| B White | F Green |
| C Red | G Blue |

STANDARD HARDWARE

AT513H for Inch
AT513M for Metric
Hex Nut (2 per switch)
Nickel/Brass

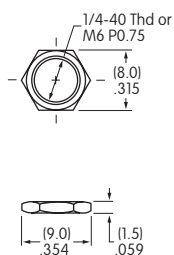

AT507H for Inch
AT507M for Metric
Locking Ring (1 per switch)
Steel with Chromate/Zinc

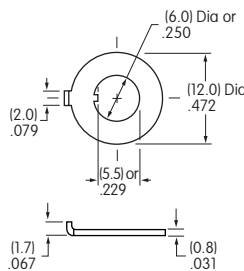

AT509
Lockwasher (1 per switch, none with splashproof)
Steel with Chromate/Zinc

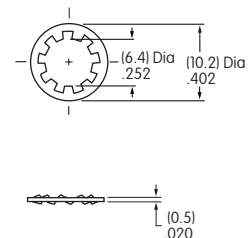

TYPICAL SWITCH DIMENSIONS

.150" Right Angle PC

Single Pole

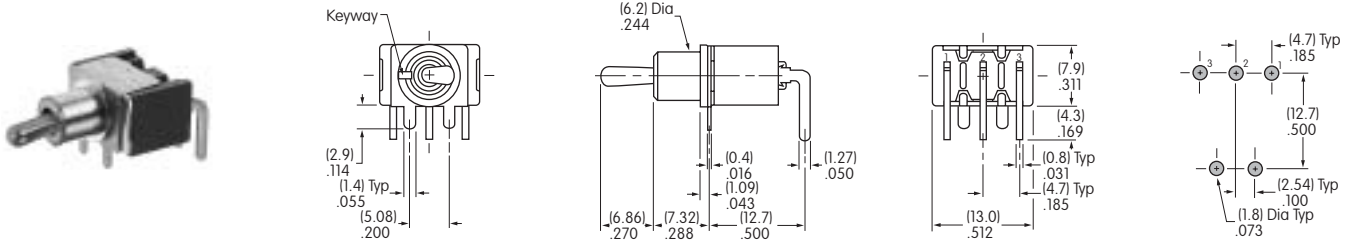

M2012S2A2G30

.150" Right Angle PC

Double Pole

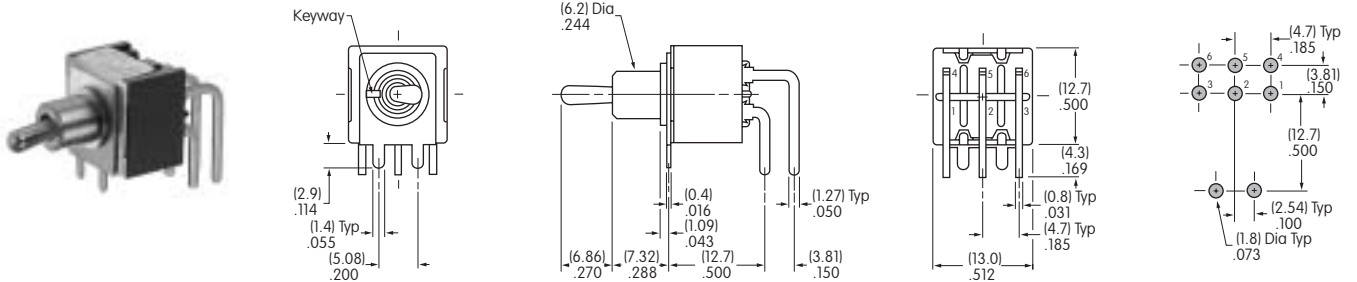

M2022S2A2G30

.150" Right Angle PC

Three Pole

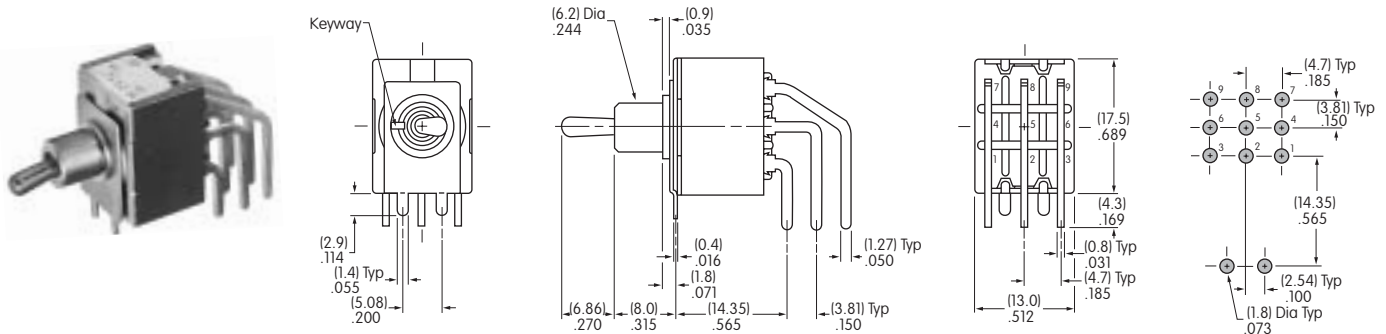

M2032S2A2G30

Right Angle PCB

Single Pole • Reverse Circuit

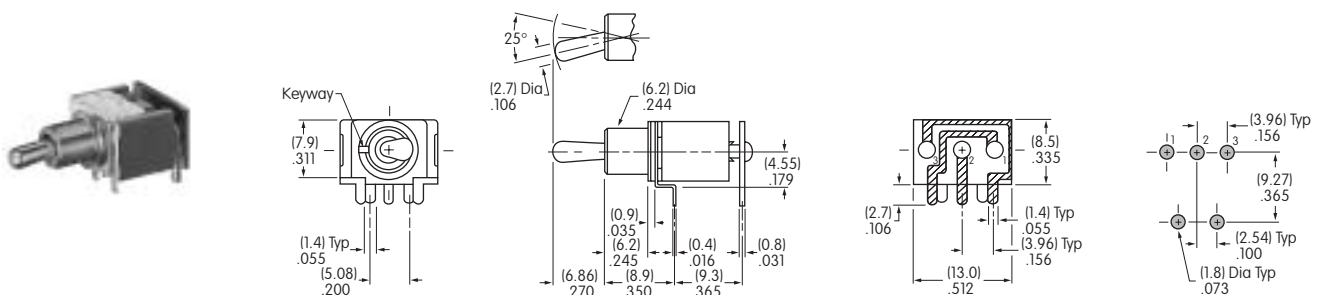

M2012S2A2G32

TYPICAL SWITCH DIMENSIONS

.150" Vertical PC

Single Pole

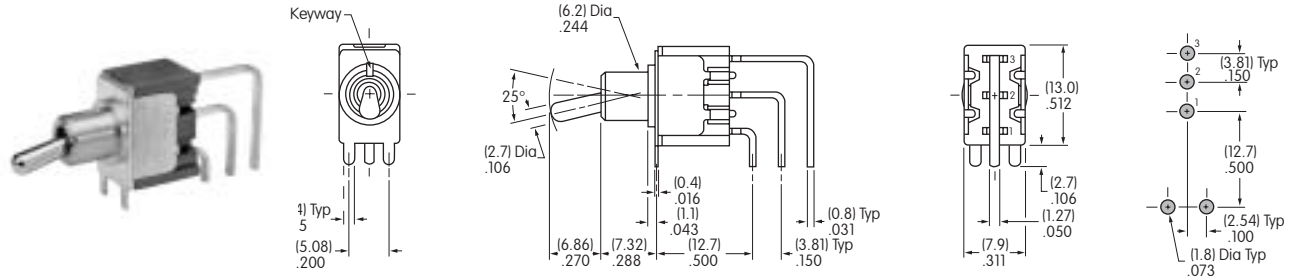

M2012S2A2G40

.150" Vertical PC

Double Pole

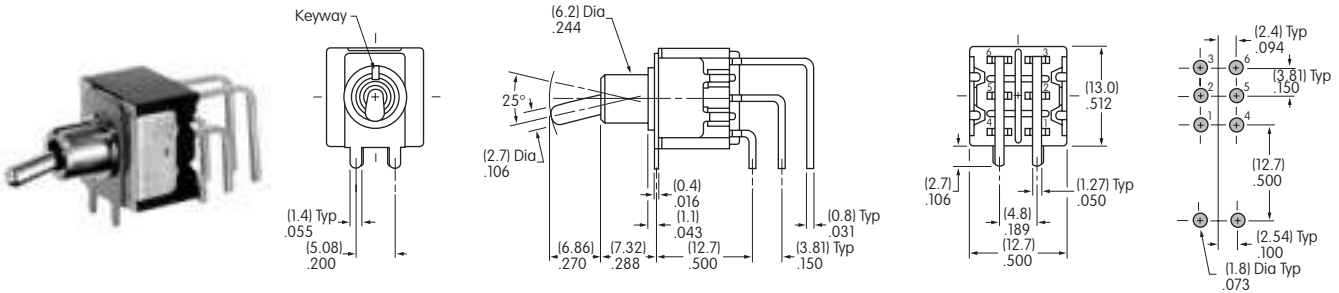

M2022S2A2G40

.150" Vertical PC

Three Pole

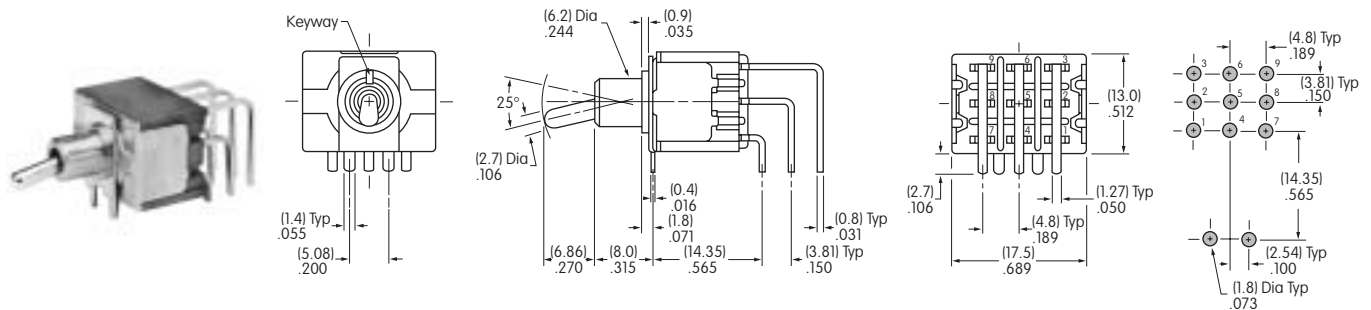

M2032S2A2G40

.150" Vertical PC

Four Pole

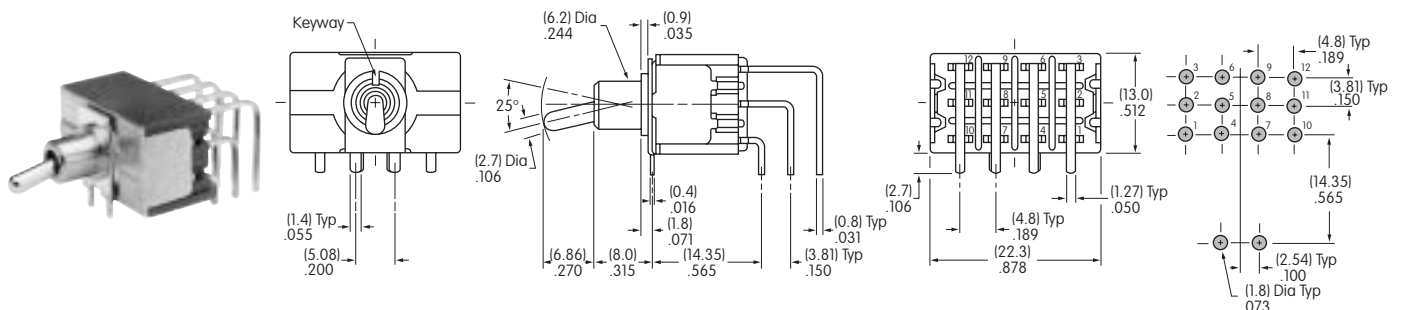

M2042S2A2G40

TYPICAL SWITCH DIMENSIONS

.100" Vertical PC

Single Pole

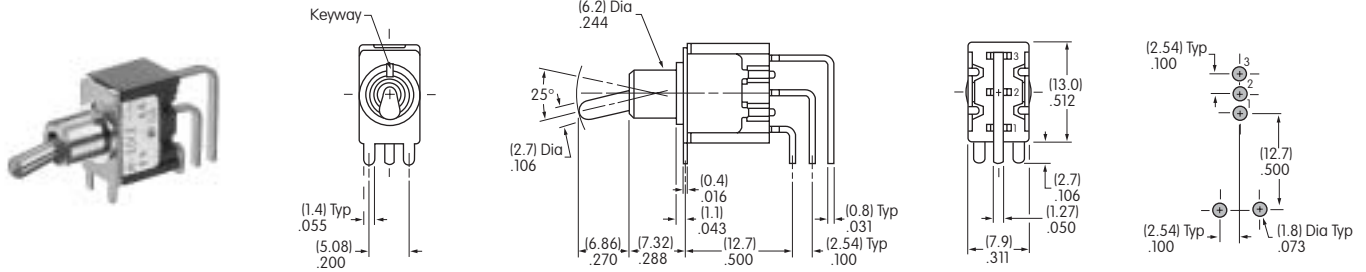

M2012S2A2G45

.100" Vertical PC

Double Pole

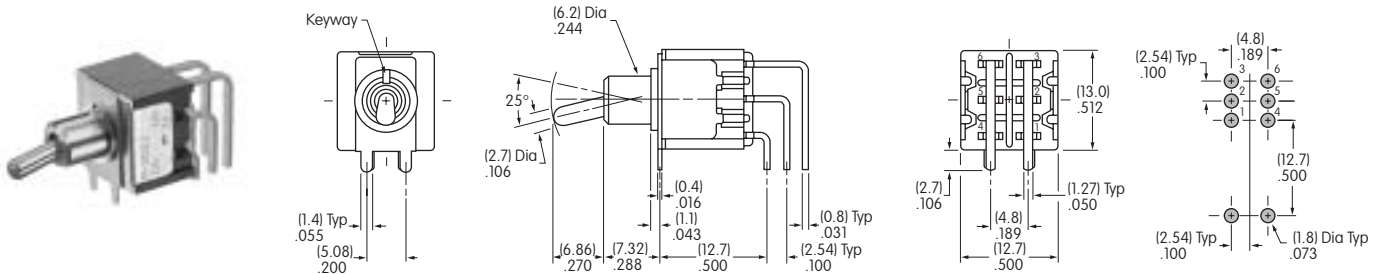

M2022S2A2G45

.100" Vertical PC

Three Pole

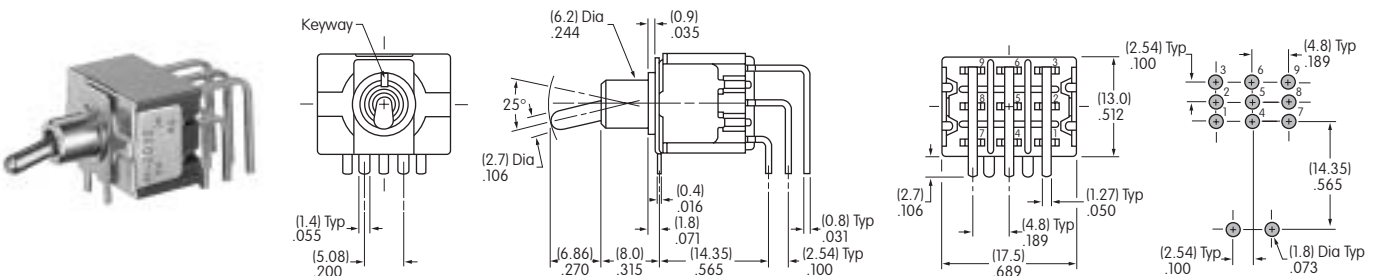

M2032S2A2G45

.100" Vertical PC

Four Pole

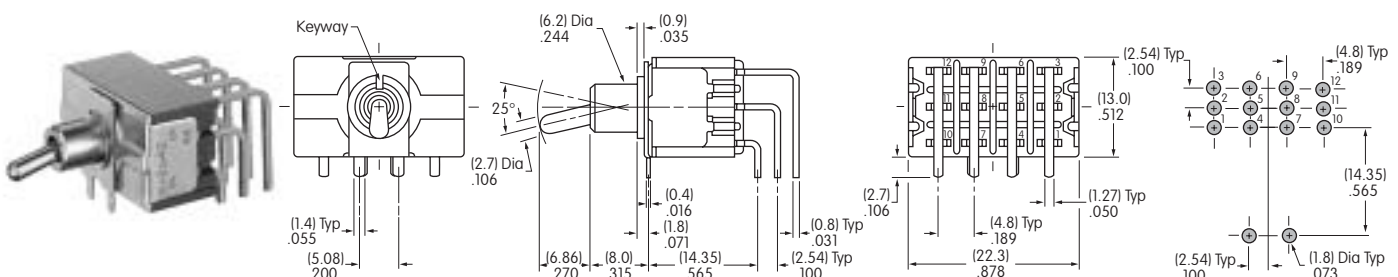

M2042S2A2G45