

Ultrafast recovery - high voltage diode

Main product characteristics

| | |
|----------------|--------|
| $I_{F(AV)}$ | 12 A |
| V_{RRM} | 1000 V |
| T_j | 175° C |
| V_F (typ) | 1.30 V |
| t_{rr} (typ) | 48 ns |

Features and benefits

- Ultrafast, soft recovery
- Very low conduction and switching losses
- High frequency and/or high pulsed current operation
- High reverse voltage capability
- High junction temperature
- Insulated packages:
 - TO-220Ins
Electrical insulation = 2500 V_{RMS}
Capacitance = 7 pF
 - TO-220FPAC
Electrical insulation = 2500 V_{RMS}
Capacitance = 12 pF

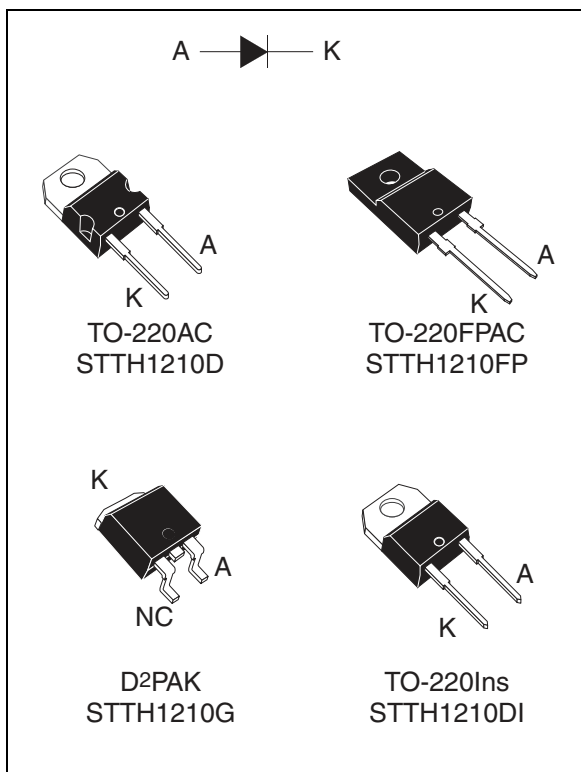

Description

The high quality design of this diode has produced a device with low leakage current, regularly reproducible characteristics and intrinsic ruggedness. These characteristics make it ideal for heavy duty applications that demand long term reliability.

Such demanding applications include industrial power supplies, motor control, and similar mission-critical systems that require rectification and freewheeling. These diodes also fit into auxiliary functions such as snubber, bootstrap, and demagnetization applications.

The improved performance in low leakage current, and therefore thermal runaway guard band, is an immediate competitive advantage for this device.

Order codes

| Part Number | Marking |
|--------------|------------|
| STTH1210D | STTH1210D |
| STTH1210G | STTH1210G |
| STTH1210G-TR | STTH1210G |
| STTH1210FP | STTH1210FP |
| STTH1210DI | STTH1210DI |

1 Characteristics

Table 1. Absolute ratings (limiting values at 25° C, unless otherwise specified)

| Symbol | Parameter | | Value | Unit | |
|--------------|---|---|--------------|------|---------------------------|
| V_{RRM} | Repetitive peak reverse voltage | | 1000 | V | |
| $I_{F(RMS)}$ | RMS forward current | TO-220AC / D ² PAK / TO-220FPAC | 30 | A | |
| | | TO-220AC Ins | 20 | | |
| $I_{F(AV)}$ | Average forward current, $\delta = 0.5$ | TO-220AC / D ² PAK | 12 | A | |
| | | TO-220FPAC | | | $T_c = 125^\circ\text{C}$ |
| | | TO-220AC Ins | | | $T_c = 40^\circ\text{C}$ |
| I_{FRM} | Repetitive peak forward current | $t_p = 5\ \mu\text{s}$, $F = 5\ \text{kHz}$ square | 120 | A | |
| I_{FSM} | Surge non repetitive forward current | $t_p = 10\ \text{ms}$ Sinusoidal | 80 | A | |
| T_{stg} | Storage temperature range | | -65 to + 175 | °C | |
| T_j | Maximum operating junction temperature | | 175 | °C | |

Table 2. Thermal parameters

| Symbol | Parameter | | Value | Unit |
|---------------|------------------|-------------------------------|-------|------|
| $R_{th(j-c)}$ | Junction to case | TO-220AC / D ² PAK | 1.9 | °C/W |
| | | TO-220FPAC | 5.4 | |
| | | TO-220AC Ins | 3.1 | |

Table 3. Static electrical characteristics

| Symbol | Parameter | Test conditions | | Min. | Typ | Max. | Unit |
|-------------|-------------------------|---------------------------|----------------------|------|------|------|---------------|
| $I_R^{(1)}$ | Reverse leakage current | $T_j = 25^\circ\text{C}$ | $V_R = V_{RRM}$ | | | 10 | μA |
| | | $T_j = 125^\circ\text{C}$ | | | 3 | 30 | |
| $V_F^{(2)}$ | Forward voltage drop | $T_j = 25^\circ\text{C}$ | $I_F = 12\ \text{A}$ | | | 2.0 | V |
| | | $T_j = 100^\circ\text{C}$ | | | 1.40 | 1.8 | |
| | | $T_j = 150^\circ\text{C}$ | | | 1.30 | 1.7 | |

1. Pulse test: $t_p = 5\ \text{ms}$, $\delta < 2\ \%$

2. Pulse test: $t_p = 380\ \mu\text{s}$, $\delta < 2\ \%$

To evaluate the conduction losses use the following equation:

$$P = 1.3 \times I_{F(AV)} + 0.033 I_{F(RMS)}^2$$

Table 4. Dynamic characteristics

| Symbol | Parameter | Test conditions | Min. | Typ | Max. | Unit |
|----------|--------------------------|---|------|-----|------|------|
| t_{rr} | Reverse recovery time | $I_F = 1\text{ A}$, $di_F/dt = -50\text{ A}/\mu\text{s}$, $V_R = 30\text{ V}$, $T_j = 25^\circ\text{ C}$ | | 67 | 90 | ns |
| | | $I_F = 1\text{ A}$, $di_F/dt = -100\text{ A}/\mu\text{s}$, $V_R = 30\text{ V}$, $T_j = 25^\circ\text{ C}$ | | 48 | 65 | |
| I_{RM} | Reverse recovery current | $I_F = 12\text{ A}$, $di_F/dt = -200\text{ A}/\mu\text{s}$, $V_R = 600\text{ V}$, $T_j = 125^\circ\text{ C}$ | | 15 | 20 | A |
| S | Softness factor | $I_F = 12\text{ A}$, $di_F/dt = -200\text{ A}/\mu\text{s}$, $V_R = 600\text{ V}$, $T_j = 125^\circ\text{ C}$ | | 2 | | |
| t_{fr} | Forward recovery time | $I_F = 12\text{ A}$ $di_F/dt = 50\text{ A}/\mu\text{s}$ $V_{FR} = 1.5 \times V_{Fmax}$, $T_j = 25^\circ\text{ C}$ | | | 400 | ns |
| V_{FP} | Forward recovery voltage | $I_F = 12\text{ A}$, $di_F/dt = 50\text{ A}/\mu\text{s}$, $T_j = 25^\circ\text{ C}$ | | 5 | | V |

Figure 1. Conduction losses versus average current

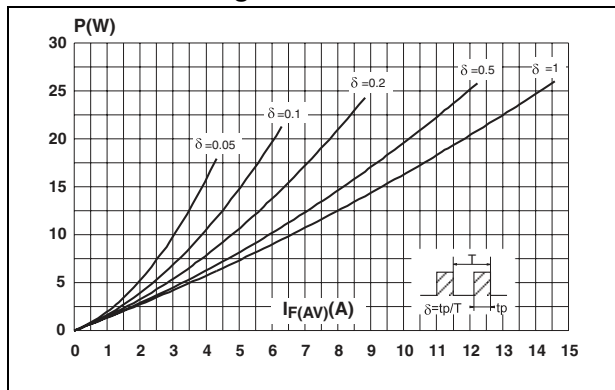

Figure 2. Forward voltage drop versus forward current

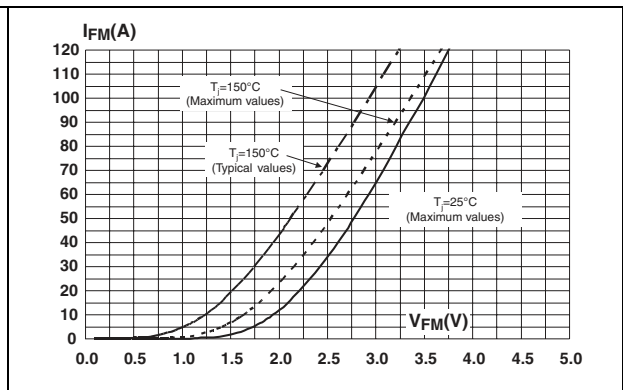

Figure 3. Relative variation of thermal impedance junction to case versus pulse duration

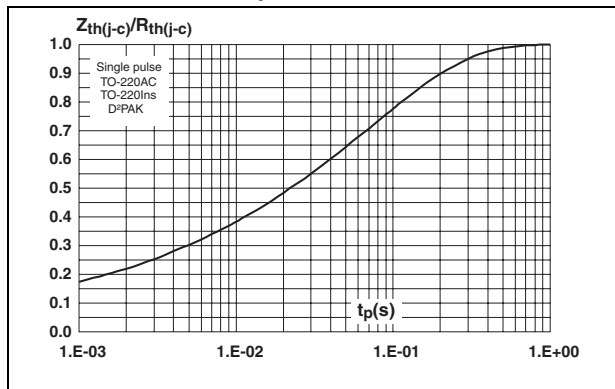

Figure 4. Relative variation of thermal impedance junction to case versus pulse duration

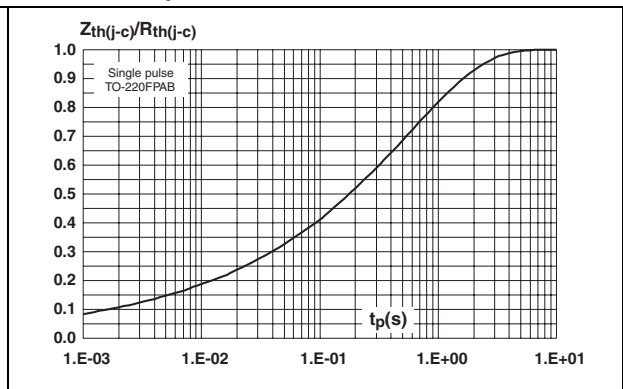

Figure 5. Peak reverse recovery current versus di_F/dt (typical values)

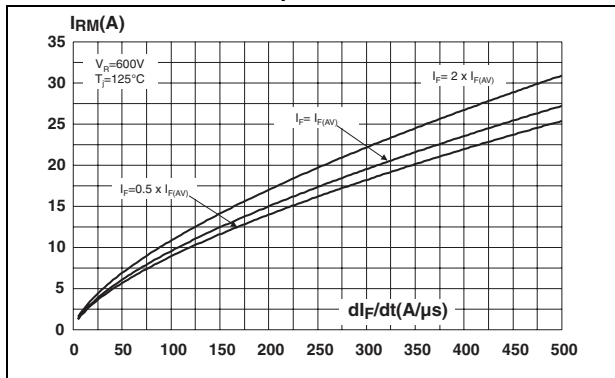

Figure 6. Reverse recovery time versus di_F/dt (typical values)

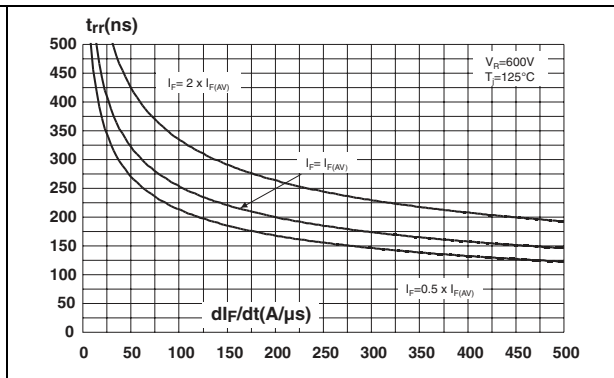

Figure 7. Reverse recovery charges versus di_F/dt (typical values)

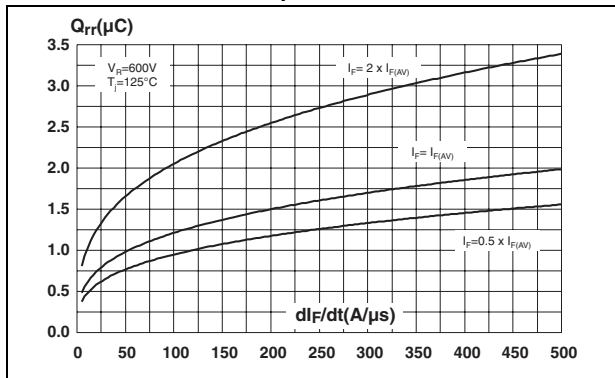

Figure 8. Softness factor versus di_F/dt (typical values)

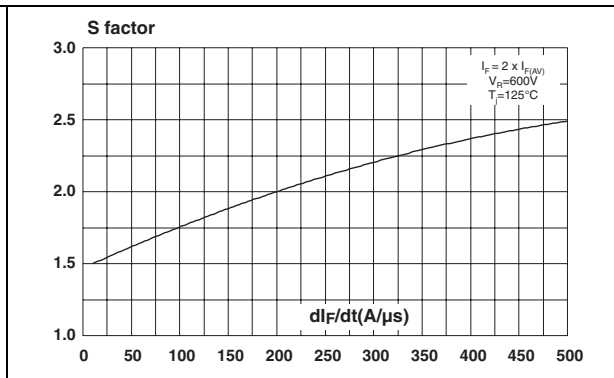

Figure 9. Relative variations of dynamic parameters versus junction temperature

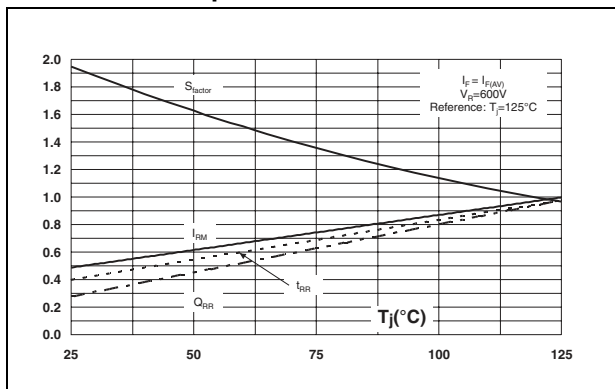

Figure 10. Transient peak forward voltage versus di_F/dt (typical values)

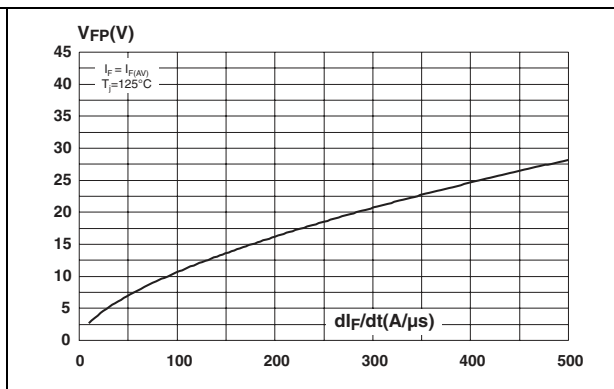

Figure 11. Forward recovery time versus dI_F/dt (typical values)

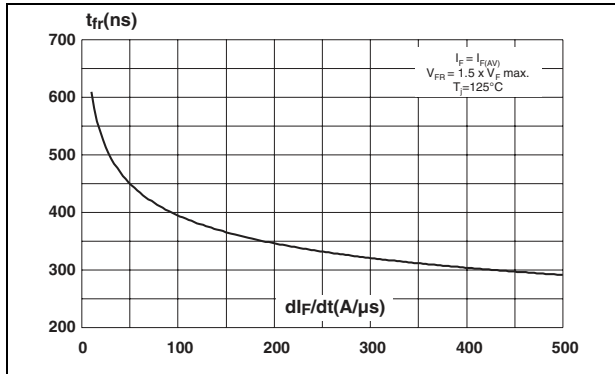

Figure 12. Junction capacitance versus reverse voltage applied (typical values)

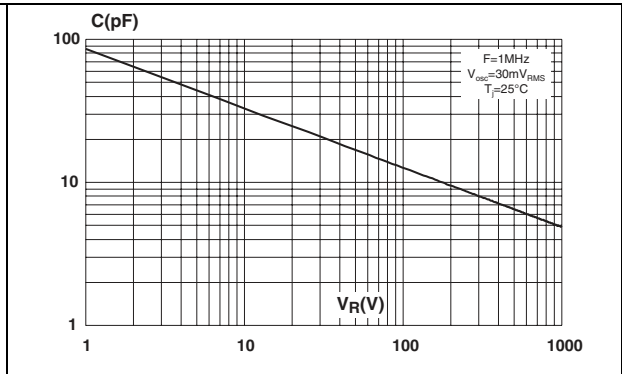
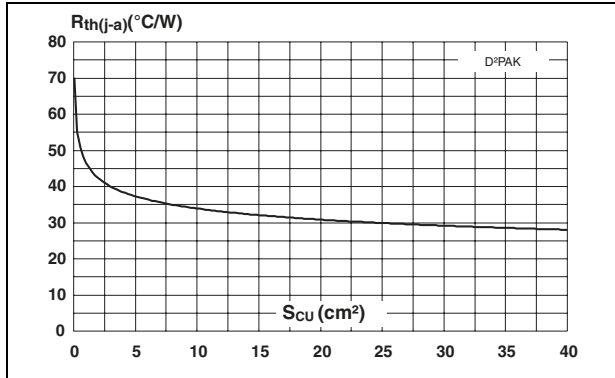

Figure 13. Thermal resistance junction to ambient versus copper surface under tab (Epoxy printed circuit board FR4, $e_{Cu} = 35 \mu\text{m}$)



2 Package information

Epoxy meets UL94, V0

Cooling method: by conduction (C)

Recommended torque value: 0.55 Nm (TO-220AC, TC-220Ins, TO-220FPAC)

Maximum torque value: 0.7 Nm (TO-220AC, TO-220Ins, TO-220FPAC)

Table 5. T0-220AC dimensions

| REF. | DIMENSIONS | | | |
|---------|-------------|-------|------------|-------|
| | Millimeters | | Inches | |
| | Min. | Max. | Min. | Max. |
| A | 4.40 | 4.60 | 0.173 | 0.181 |
| C | 1.23 | 1.32 | 0.048 | 0.051 |
| D | 2.40 | 2.72 | 0.094 | 0.107 |
| E | 0.49 | 0.70 | 0.019 | 0.027 |
| F | 0.61 | 0.88 | 0.024 | 0.034 |
| F1 | 1.14 | 1.70 | 0.044 | 0.066 |
| G | 4.95 | 5.15 | 0.194 | 0.202 |
| H2 | 10.00 | 10.40 | 0.393 | 0.409 |
| L2 | 16.40 typ. | | 0.645 typ. | |
| L4 | 13.00 | 14.00 | 0.511 | 0.551 |
| L5 | 2.65 | 2.95 | 0.104 | 0.116 |
| L6 | 15.25 | 15.75 | 0.600 | 0.620 |
| L7 | 6.20 | 6.60 | 0.244 | 0.259 |
| L9 | 3.50 | 3.93 | 0.137 | 0.154 |
| M | 2.6 typ. | | 0.102 typ. | |
| Diam. I | 3.75 | 3.85 | 0.147 | 0.151 |

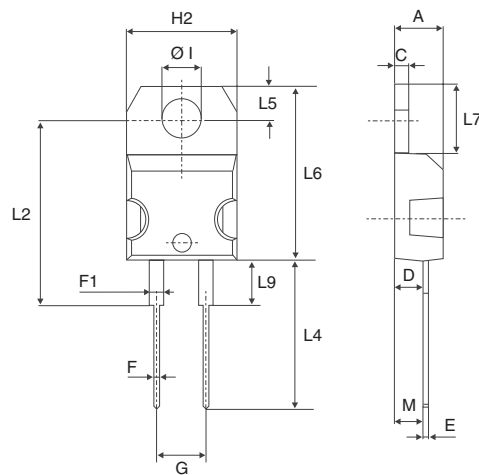

Table 6. T0-220Ins dimensions

| REF | DIMENSIONS | | | | | |
|-----|-------------|-------|-------|--------|-------|-------|
| | Millimeters | | | Inches | | |
| | Min. | | Max. | Min. | | Max. |
| A | 15.20 | | 15.90 | 0.598 | | 0.625 |
| a1 | | 3.75 | | | 0.147 | |
| a2 | 13.00 | | 14.00 | 0.511 | | 0.551 |
| B | 10.00 | | 10.40 | 0.393 | | 0.409 |
| b1 | 0.61 | | 0.88 | 0.024 | | 0.034 |
| b2 | 1.23 | | 1.32 | 0.048 | | 0.051 |
| C | 4.40 | | 4.60 | 0.173 | | 0.181 |
| c1 | 0.49 | | 0.70 | 0.019 | | 0.027 |
| c2 | 2.40 | | 2.72 | 0.094 | | 0.107 |
| e | 4.80 | | 5.40 | 0.189 | | 0.212 |
| F | 6.20 | | 6.60 | 0.244 | | 0.259 |
| ØI | 3.75 | | 3.85 | 0.147 | | 0.151 |
| l4 | 15.80 | 16.40 | 16.80 | 0.622 | 0.646 | 0.661 |
| L | 2.65 | | 2.95 | 0.104 | | 0.116 |
| l2 | 1.14 | | 1.70 | 0.044 | | 0.066 |
| M | | 2.60 | | | 0.102 | |

Table 7. T0-220FPAC dimensions

| REF | DIMENSIONS | | | |
|------|-------------|------|-----------|-------|
| | Millimeters | | Inches | |
| | Min. | Max. | Min. | Max. |
| A | 4.4 | 4.6 | 0.173 | 0.181 |
| B | 2.5 | 2.7 | 0.098 | 0.106 |
| D | 2.5 | 2.75 | 0.098 | 0.108 |
| E | 0.45 | 0.70 | 0.018 | 0.027 |
| F | 0.75 | 1 | 0.030 | 0.039 |
| F1 | 1.15 | 1.70 | 0.045 | 0.067 |
| G | 4.95 | 5.20 | 0.195 | 0.205 |
| G1 | 2.4 | 2.7 | 0.094 | 0.106 |
| H | 10 | 10.4 | 0.393 | 0.409 |
| L2 | 16 Typ. | | 0.63 Typ. | |
| L3 | 28.6 | 30.6 | 1.126 | 1.205 |
| L4 | 9.8 | 10.6 | 0.386 | 0.417 |
| L5 | 2.9 | 3.6 | 0.114 | 0.142 |
| L6 | 15.9 | 16.4 | 0.626 | 0.646 |
| L7 | 9.00 | 9.30 | 0.354 | 0.366 |
| Dia. | 3.00 | 3.20 | 0.118 | 0.126 |

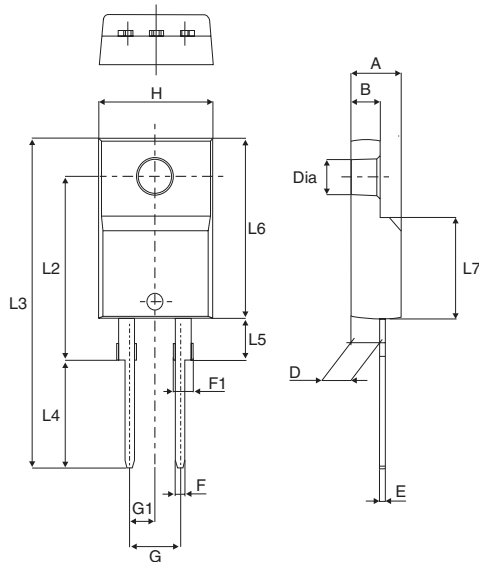
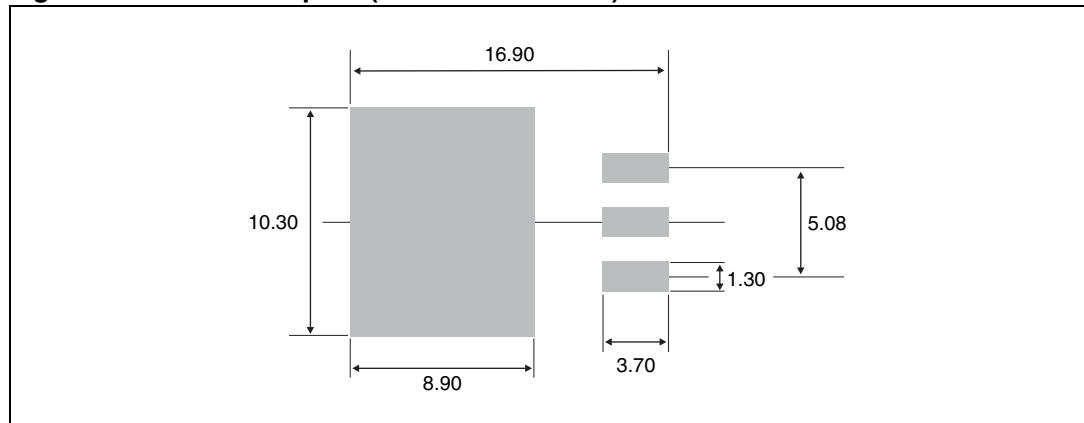

Table 8. D²PAK dimensions

| REF. | DIMENSIONS | | | |
|------|-------------|-------|------------|-------|
| | Millimeters | | Inches | |
| | Min. | Max | Min. | Max. |
| A | 4.40 | 4.60 | 0.173 | 0.181 |
| A1 | 2.49 | 2.69 | 0.098 | 0.106 |
| A2 | 0.03 | 0.23 | 0.001 | 0.009 |
| B | 0.70 | 0.93 | 0.027 | 0.037 |
| B2 | 1.14 | 1.70 | 0.045 | 0.067 |
| C | 0.45 | 0.60 | 0.017 | 0.024 |
| C2 | 1.23 | 1.36 | 0.048 | 0.054 |
| D | 8.95 | 9.35 | 0.352 | 0.368 |
| E | 10.00 | 10.40 | 0.393 | 0.409 |
| G | 4.88 | 5.28 | 0.192 | 0.208 |
| L | 15.00 | 15.85 | 0.590 | 0.624 |
| L2 | 1.27 | 1.40 | 0.050 | 0.055 |
| L3 | 1.40 | 1.75 | 0.055 | 0.069 |
| M | 2.40 | 3.20 | 0.094 | 0.126 |
| R | 0.40 typ. | | 0.016 typ. | |
| V2 | 0° | 8° | 0° | 8° |

Figure 14. D²PAK footprint (dimensions in mm)



In order to meet environmental requirements, ST offers these devices in ECOPACK® packages. These packages have a Lead-free second level interconnect . The category of second level interconnect is marked on the package and on the inner box label, in compliance with JEDEC Standard JESD97. The maximum ratings related to soldering conditions are also marked on the inner box label. ECOPACK is an ST trademark. ECOPACK specifications are available at: www.st.com.

3 Ordering information

| Part Number | Marking | Package | Weight | Base qty | Delivery mode |
|--------------|------------|--------------------|--------|----------|---------------|
| STTH1210D | STTH1210D | TO-220AC | 1.86 g | 50 | Tube |
| STTH1210DI | STTH1210DI | TO-220Ins | 1.86 g | 50 | Tube |
| STTH1210FP | STTH1210FP | TO-220FPAC | 2.2 g | 50 | Tube |
| STTH1210G | STTH1210G | D ² PAK | 1.48 g | 50 | Tube |
| STTH1210G-TR | STTH1210G | D ² PAK | 1.48 g | 1000 | Tape & reel |

4 Revision history

| Date | Revision | Description of Changes |
|-------------|----------|------------------------|
| 02-Mar-2006 | 1 | First issue. |

Please Read Carefully:

Information in this document is provided solely in connection with ST products. STMicroelectronics NV and its subsidiaries ("ST") reserve the right to make changes, corrections, modifications or improvements, to this document, and the products and services described herein at any time, without notice.

All ST products are sold pursuant to ST's terms and conditions of sale.

Purchasers are solely responsible for the choice, selection and use of the ST products and services described herein, and ST assumes no liability whatsoever relating to the choice, selection or use of the ST products and services described herein.

No license, express or implied, by estoppel or otherwise, to any intellectual property rights is granted under this document. If any part of this document refers to any third party products or services it shall not be deemed a license grant by ST for the use of such third party products or services, or any intellectual property contained therein or considered as a warranty covering the use in any manner whatsoever of such third party products or services or any intellectual property contained therein.

UNLESS OTHERWISE SET FORTH IN ST'S TERMS AND CONDITIONS OF SALE ST DISCLAIMS ANY EXPRESS OR IMPLIED WARRANTY WITH RESPECT TO THE USE AND/OR SALE OF ST PRODUCTS INCLUDING WITHOUT LIMITATION IMPLIED WARRANTIES OF MERCHANTABILITY, FITNESS FOR A PARTICULAR PURPOSE (AND THEIR EQUIVALENTS UNDER THE LAWS OF ANY JURISDICTION), OR INFRINGEMENT OF ANY PATENT, COPYRIGHT OR OTHER INTELLECTUAL PROPERTY RIGHT.

UNLESS EXPRESSLY APPROVED IN WRITING BY AN AUTHORIZED REPRESENTATIVE OF ST, ST PRODUCTS ARE NOT DESIGNED, AUTHORIZED OR WARRANTED FOR USE IN MILITARY, AIR CRAFT, SPACE, LIFE SAVING, OR LIFE SUSTAINING APPLICATIONS, NOR IN PRODUCTS OR SYSTEMS, WHERE FAILURE OR MALFUNCTION MAY RESULT IN PERSONAL INJURY, DEATH, OR SEVERE PROPERTY OR ENVIRONMENTAL DAMAGE.

Resale of ST products with provisions different from the statements and/or technical features set forth in this document shall immediately void any warranty granted by ST for the ST product or service described herein and shall not create or extend in any manner whatsoever, any liability of ST.

ST and the ST logo are trademarks or registered trademarks of ST in various countries.

Information in this document supersedes and replaces all information previously supplied.

The ST logo is a registered trademark of STMicroelectronics. All other names are the property of their respective owners.

© 2006 STMicroelectronics - All rights reserved

STMicroelectronics group of companies

Australia - Belgium - Brazil - Canada - China - Czech Republic - Finland - France - Germany - Hong Kong - India - Israel - Italy - Japan - Malaysia - Malta - Morocco - Singapore - Spain - Sweden - Switzerland - United Kingdom - United States of America

www.st.com