

ELUA3535OGB

Series



Introduction

The ELUA3535OGB product series is a ceramic based LED with high quality and reliability that suitable for UV application.

Features

- ◆ Low power UVA LED
- ◆ Dimension 3.5mm*3.5mm*2.35mm
- ◆ ESD protection up to 2KV
- ◆ RoHS compliant
- ◆ Pb free
- ◆ EU REACH compliant
- ◆ Halogen Free compliant
- ◆ (Br<900ppm,Cl<900ppm,Br+Cl<1500ppm)

Applications

- ◆ UV Sterilization System
- ◆ UV Photo-catalyst
- ◆ UV Sensor Light

Product Nomenclature

ELUA3535OGB-PXXXXYY3240500-VD1M

EL = Everlight

UA = UVA

3535 = 3.5mm x 3.5mm Package

O = Package Material: Al₂O₃

G = Coating: Ag

B = Angle: 120°

P = Peak Wavelength

XXXX = Wavelength Range [1]

YY = Minimum Radiant Flux Spec [2]

3240 = Forward Voltage Spec: 3.2~4.0V

500 = Forward Current: 500mA

V = Chip Type: Vertical

D = Chip Size: 45mil

1 = Chip QTY: 1 chip

M = Process Type: Molding

Notes:

1. Wavelength Range

Symbol	Description
6070	360~370nm
8090	380~390nm
9000	390~400nm
0010	400~410nm

2. Minimum Radiant Flux Spec

Symbol	Description
U2	1000mW

Absolute Maximum Ratings

Parameter	Symbol	Ratings	Unit
Max. DC Forward Current (mA) (For 385nm · 395nm · 405nm)	I_F	1000	mA
Max. DC Forward Current (mA) (Only 365nm)	I_F	700	mA
Max. ESD Resistance	V_B	2000	V
Thermal Resistance	R_{th}	4	°C/W
Max. Junction Temperature	T_J	130	°C
Operating Temperature	T_{Opr}	-10 ~ +100	°C
Storage Temperature	T_{Stg}	-40 ~ +100	°C

PN of the ELUA3535OGB series: UVA LEDs

Color	Order Code of ELUA3535OGB	Forward Current (mA)	Minimum Radiant Flux (mW)	Peak Wavelength (nm)	Forward Voltage (V)
Ultraviolet	ELUA3535OGB-P6070U23240500-VD1M	500	1000	360~370	3.2~4.0
	ELUA3535OGB-P8090U23240500-VD1M	500	1000	380~390	3.2~4.0
	ELUA3535OGB-P9000U23240500-VD1M	500	1000	390~400	3.2~4.0
	ELUA3535OGB-P0010U23240500-VD1M	500	1000	400~410	3.2~4.0

Product Binning Radiant Flux Bins

Bin Code	Minimum Radiant Flux (mW)	Maximum Radiant Flux (mW)
U2	1000	1100
U3	1100	1200
U4	1200	1300
U5	1300	1400
U6	1400	1500

Notes:

- 1.Radiant flux measurement tolerance: $\pm 10\%$.
- 2.Forward voltage bins are defined at $I_F=500\text{mA}$ operation.

Peak Wavelength Bins

Group	Bin	Minimum Peak Wavelength (nm)	Maximum Peak Wavelength (nm)
U	36	360	370
	38	380	390
	39	390	400
	40	400	410

Notes:

- 1.Peak Wavelength measurement tolerance: $\pm 1\text{nm}$.
- 2.Forward voltage bins are defined at $I_F=500\text{mA}$ operation.

Forward Voltage Bins

Bin	Minimum Forward Voltage (V)	Maximum Forward Voltage (V)
3234	3.2	3.4
3436	3.4	3.6
3638	3.6	3.8
3840	3.8	4.0

Notes:

- 1.Forward voltage measurement tolerance: $\pm 2\%$.
- 2.Forward voltage bins are defined at $I_F=500\text{mA}$ operation.

Mechanical Dimension

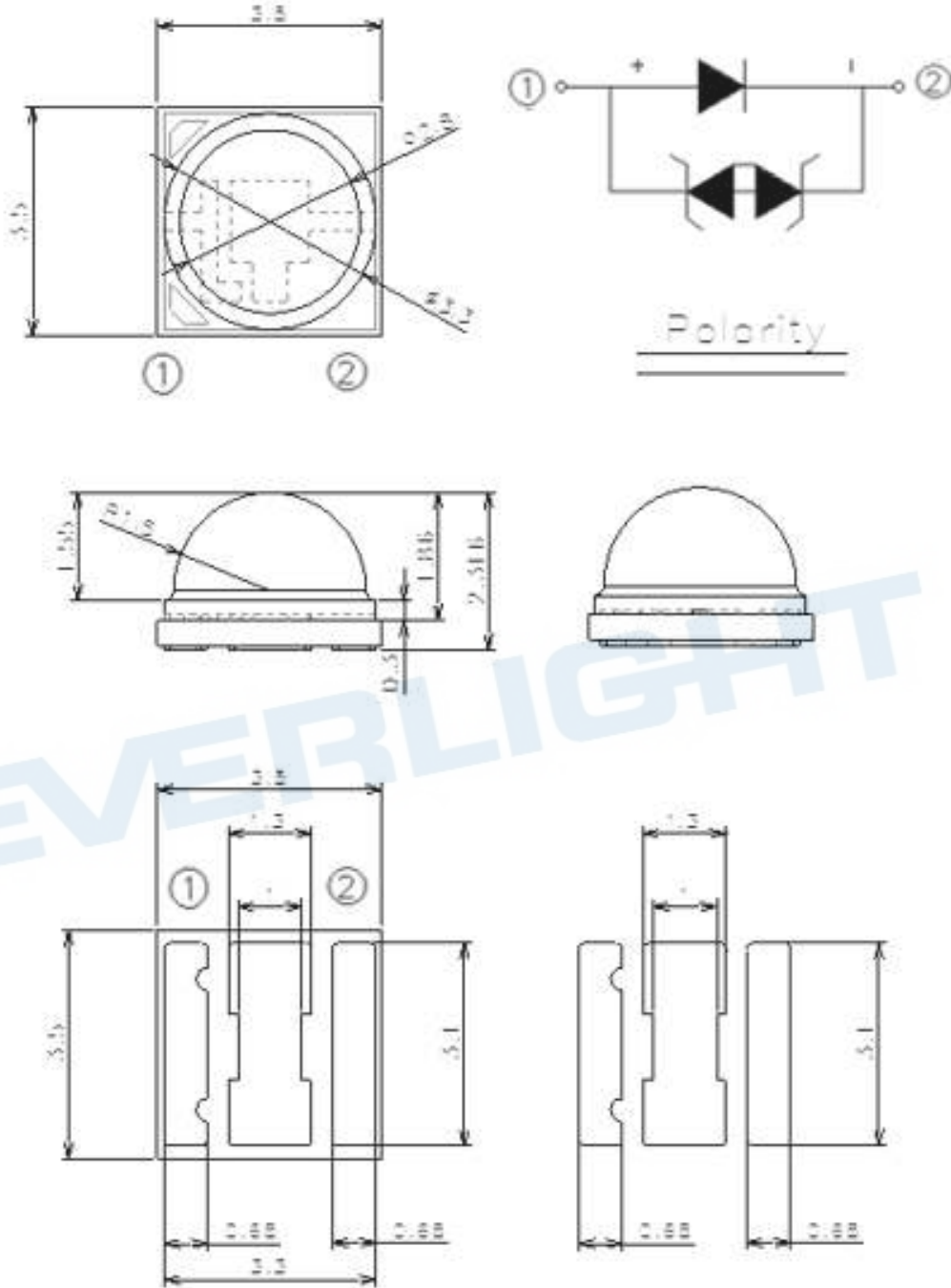

1. Dimensions are in millimeters.
2. Tolerances unless mentioned are $\pm 0.1\text{mm}$

Pad Configuration

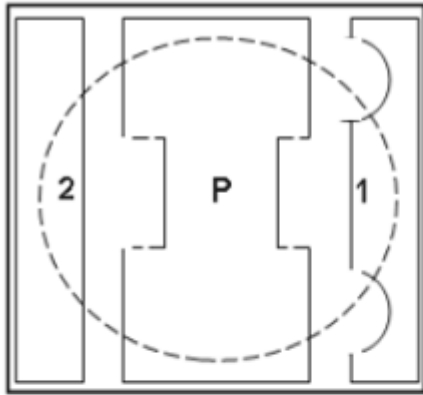

BOTTOM VIEW

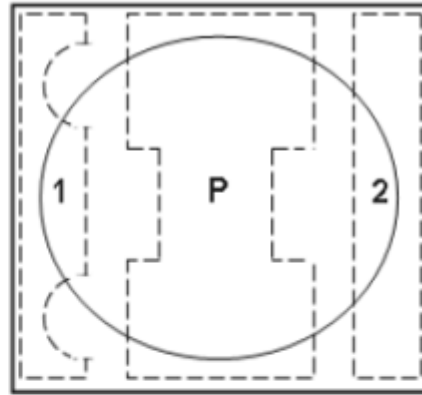

TOP VIEW

PAD	FUNCTION
1	ANODE
2	CATHODE
P	THERMAL PAD

Reflow Soldering Characteristics

For Reflow Process

- ELUA series are suitable for SMT processes.
- Curing of glue in oven must be according to standard operation flow processes.

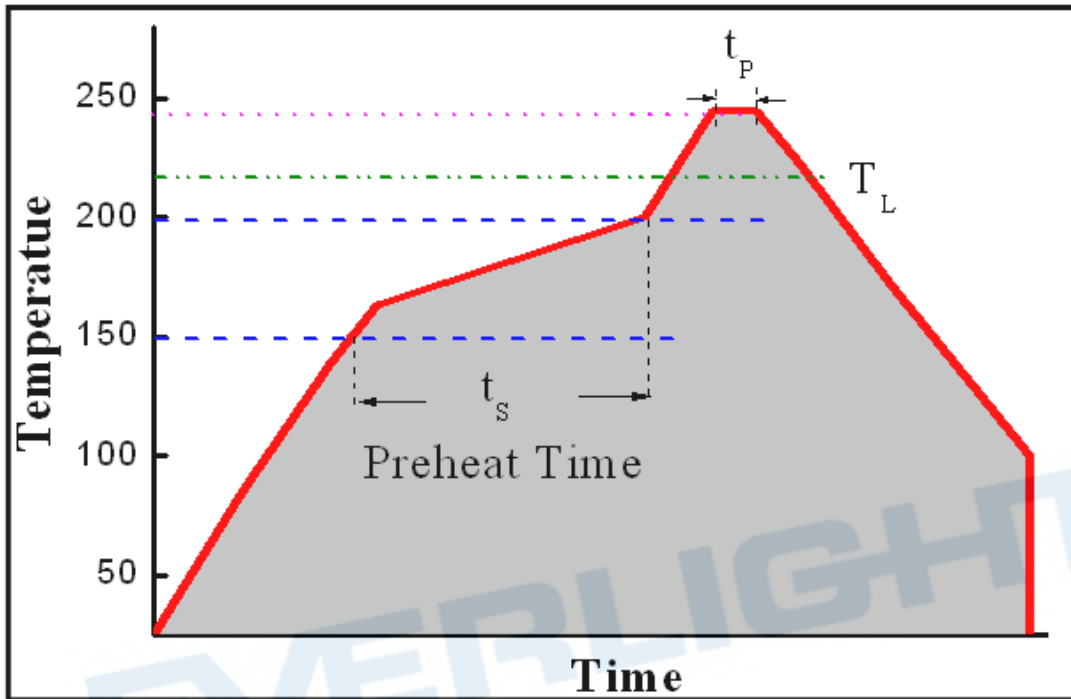

Profile Feature	Lead Free Assembly
Ramp-Up Rate	2-3 °C/S
Preheat Temperature	150-200 °C
Preheat Time (t_s)	60-120 S
Liquid Temperature (T_L)	217 °C
Time maintained above T_L	60-90 S
Peak Temperature (T_p)	240±5 °C
Peak Time (t_p)	Max 20 S
Ramp-Down Rate	3-5 °C/S

- Reflow soldering should not be done more than twice.
- In soldering process, stress on the LEDs during heating should be avoided.
- After soldering, do not bend the circuit board.

Typical Characteristics Curves

Spectrum @ Thermal Pad Temperature = 25°C

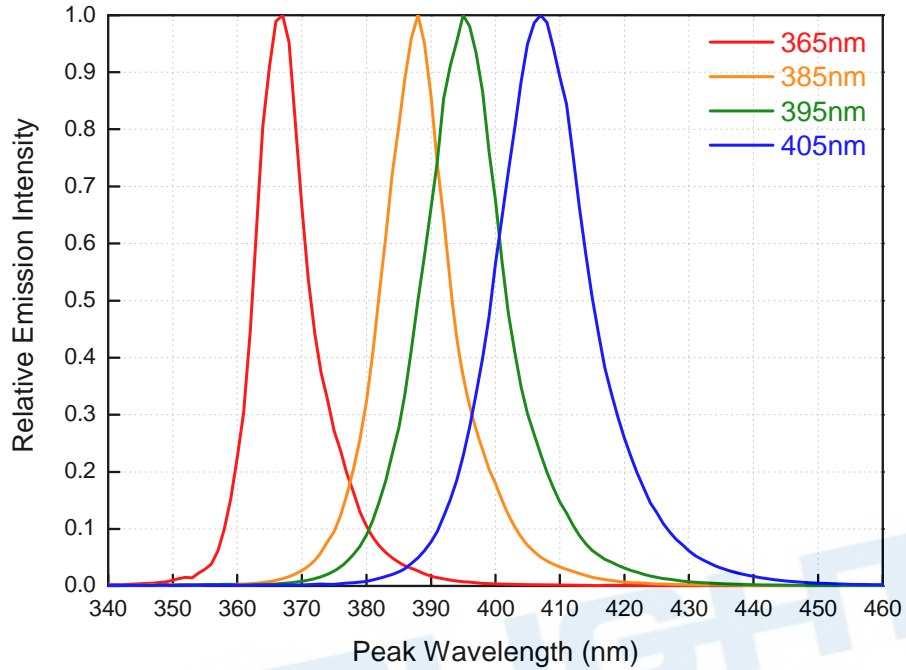

Relative Radiant Flux vs. Forward Current
@ Thermal Pad Temperature = 25°C

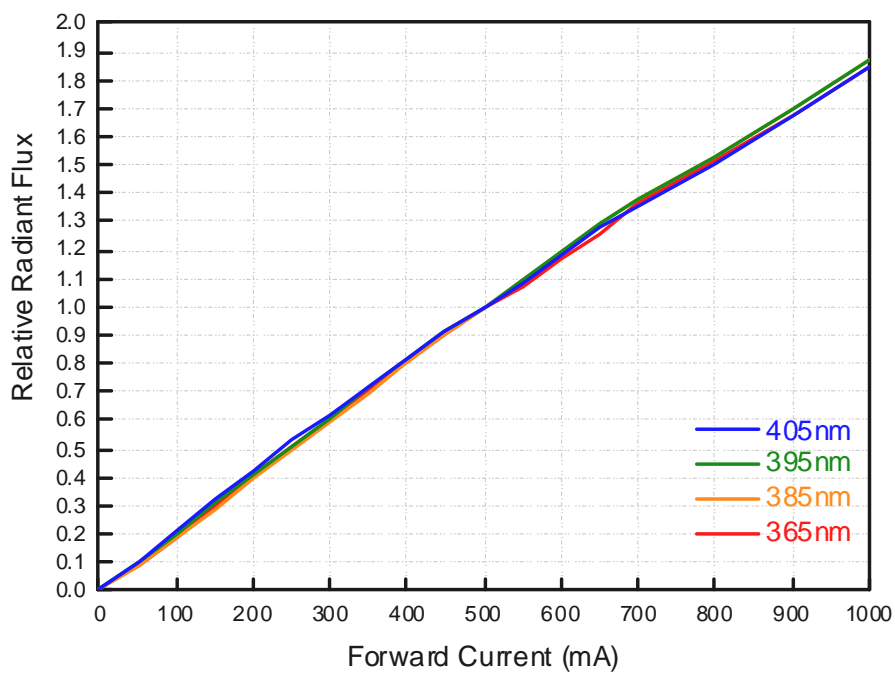

Peak Wavelength vs. Forward Current @ Thermal Pad Temperature = 25°C

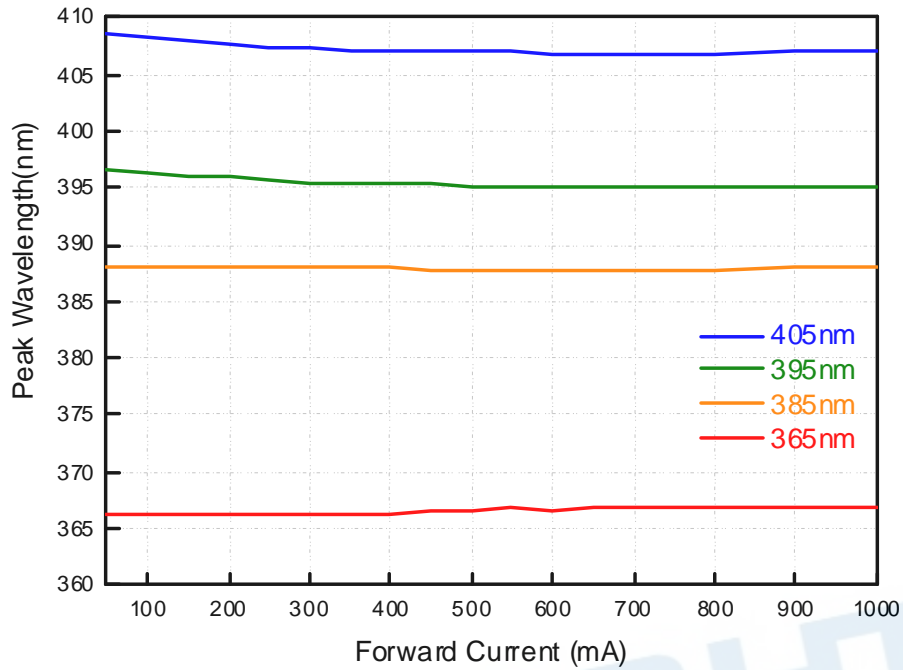

Forward Voltage vs. Forward Current @ Thermal Pad Temperature = 25°C

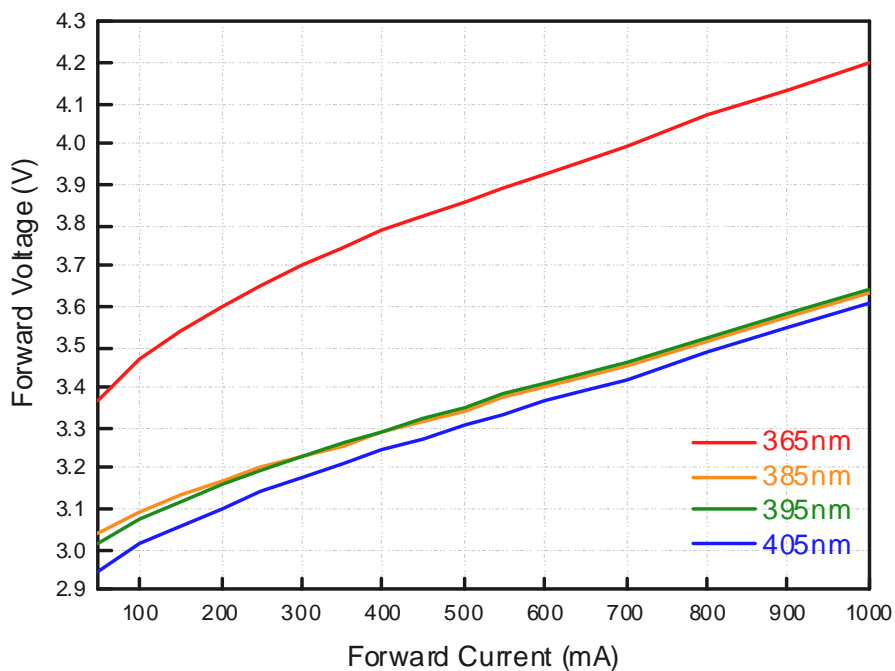

Relative Radiant Flux vs. Ambient Temperature @ Forward Current = 500mA

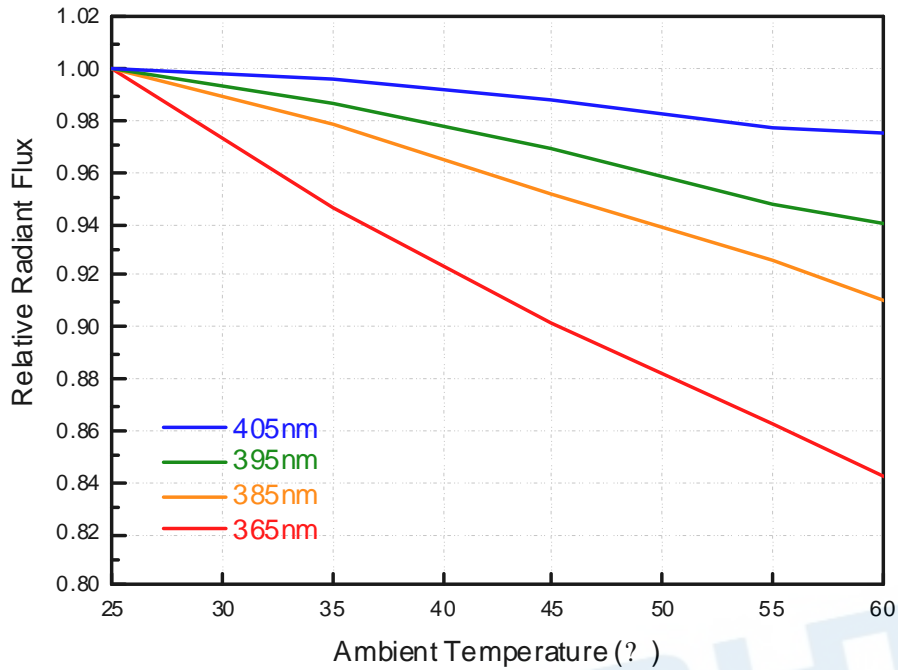

Peak Wavelength vs. Ambient Temperature @ Forward Current = 500mA

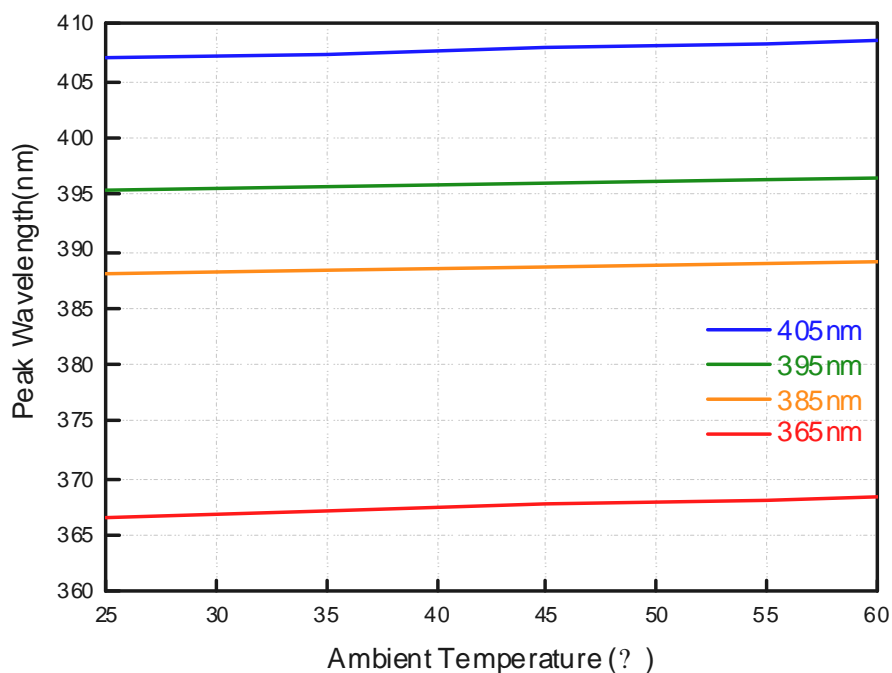

Forward Voltage vs. Ambient Temperature @ Forward Current = 500mA

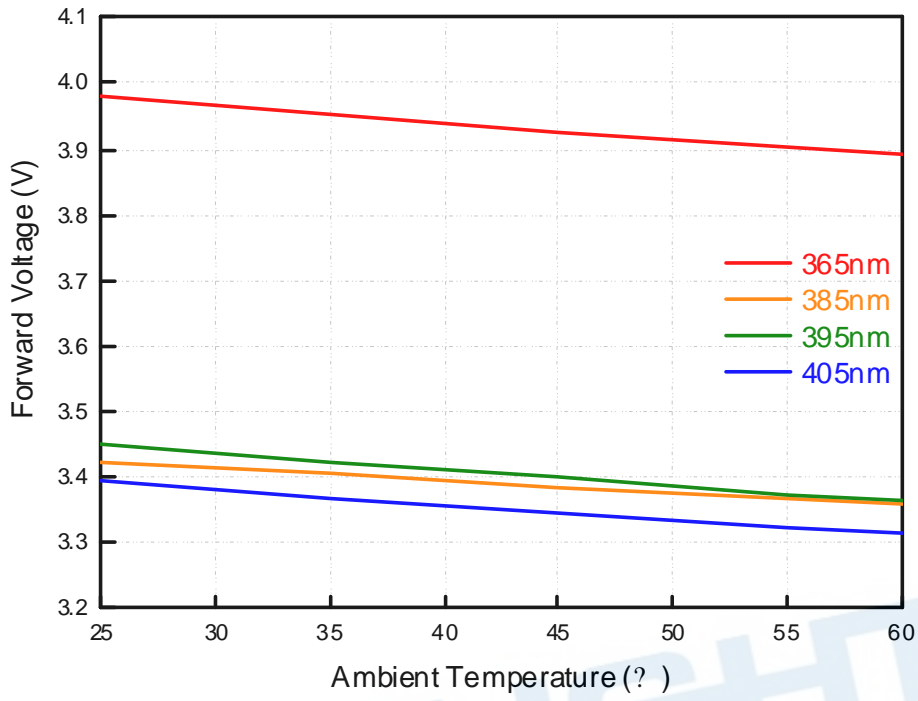

Derating Curve

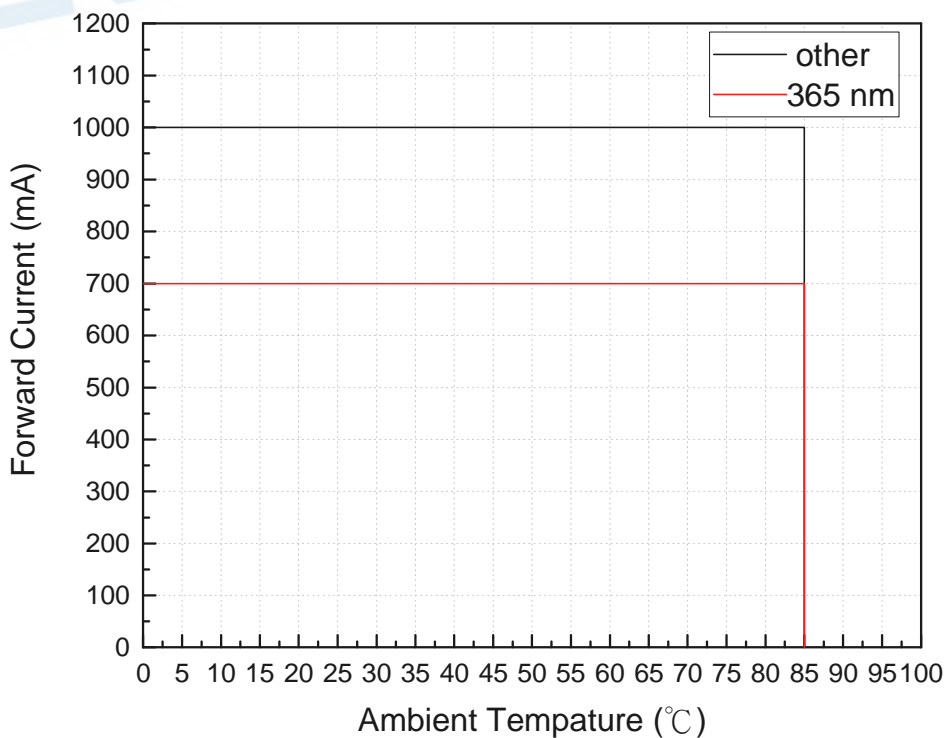

Typical Radiation Patterns

Typical Diagram Characteristics of Radiation for ELUA3535OGB

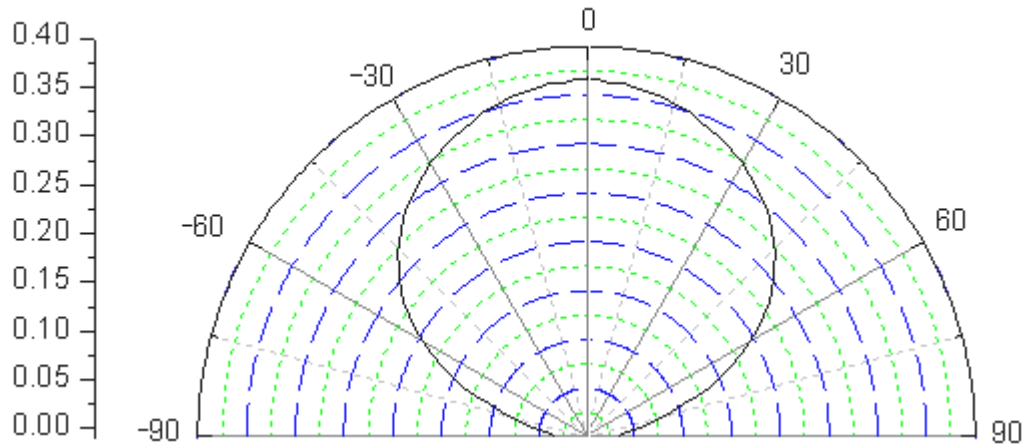

Notes:

1. $2\theta_{1/2}$ is the off axis angle from lamp centerline where the luminous intensity is 1/2 of the peak value.
2. View angle tolerance is $\pm 5^\circ$.

EVERLIGHT

Emitter Tape Packaging

Carrier Tape Dimensions as the following:

Reel: 800pcs

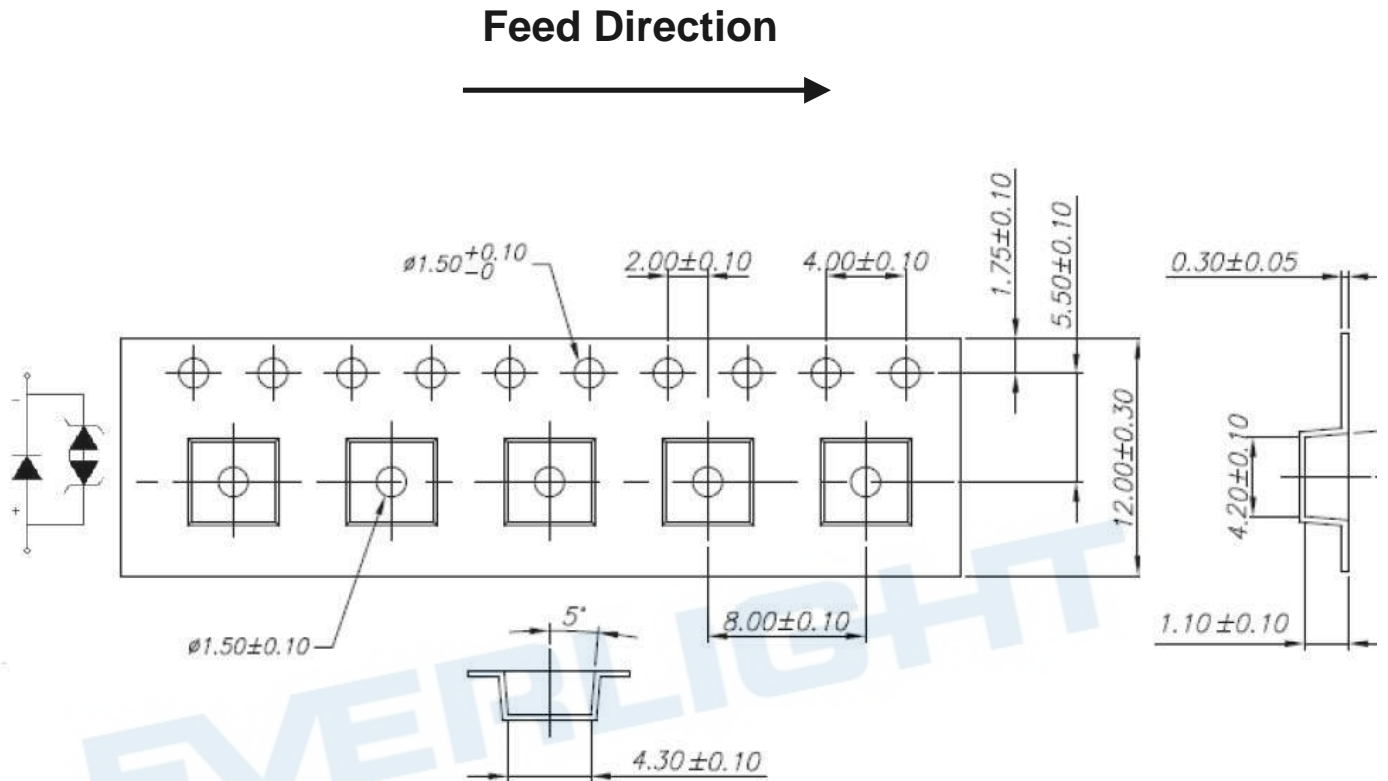

Note

1. Tolerance unless mentioned is $\pm 0.1\text{mm}$;
2. Packing amount is 200/400/600/800 pcs per reel

Moisture Resistant Packaging

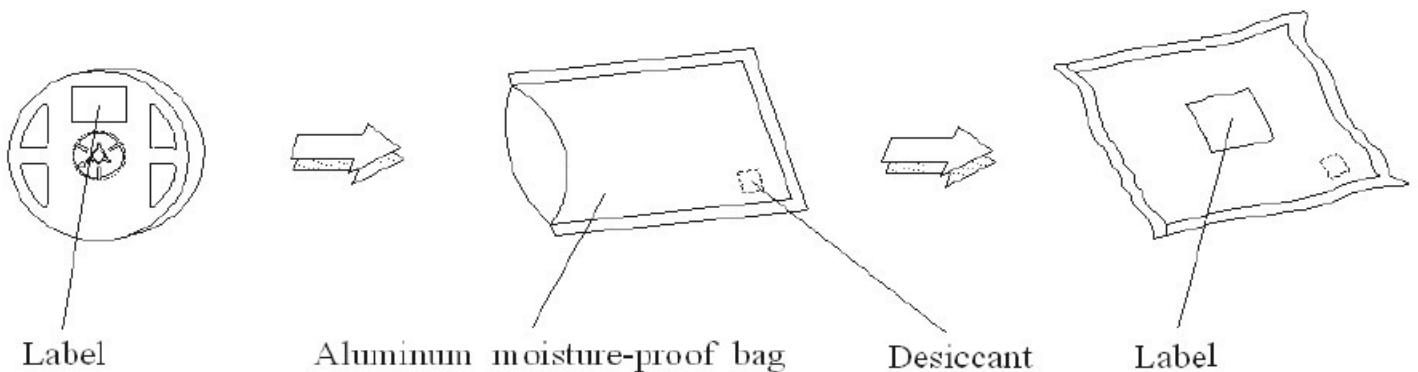

Emitter Reel Dimensions

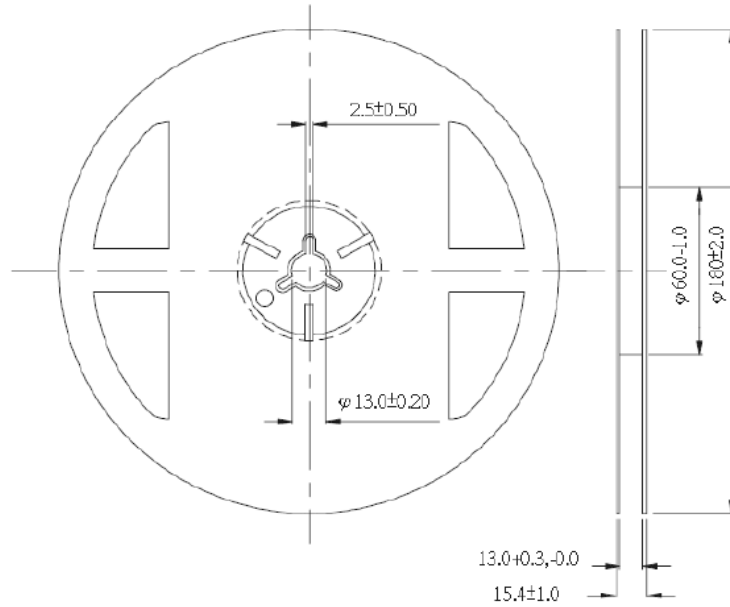

Notes:

1. Dimensions are in millimeters.
2. Tolerances unless mentioned are ±0.1mm.

Product Labeling

Label Explanation

- CPN: Customer Specification (when required)
- P/N : Everlight Production Number
- QTY: Packing Quantity
- CAT: Luminous Flux (Brightness) Bin
- HUE: Color Bin
- REF: Forward Voltage Bin
- LOT No: Lot Number
- MADE IN TAIWAN: Production Place

RoHS		EVERLIGHT	5
CPN: XXXXXXXXXXXXXXXXXXXX			
XXXXXXXXXX-XXXXXXXXXX-XXXXXXXXXX-XXXXXXXXXX-XXXXXX			
P/N: XXXXXXXXXXXX			
XXXXXXXXXX-XXXXXXXXXX-XXXXXXXXXX-XXXXXXXXXX-XXXXXX			
LOT NO: Y150716XXX-XXXXXXXXXX-XXXXXXXXXX			
QTY: 0123456789 HUE: XXXXXXXXXXXX			
CAT: XXXXXXXXXXXX REF: XXXXXXXXXXXX			
REFERENCE: BTPYYMDDXXXXX			
MSL-X		MADE IN XXXXXX	



Storage Conditions

- Before the package is opened. The LEDs should be stored at 30°C or less and 90%RH or less after being shipped from EVERLIGHT and the storage life limits are 12 months.
- After opening the package: The LED's floor life is unlimited under 30°C or less and 85% RH or less. If unused LEDs remain, it should be stored in moisture proof packages.
- If the moisture absorbent material (silica gel) has faded away or the LEDs have exceeded the storage time, baking treatment should be performed using the following conditions. Baking treatment: 60±5°C for 24 hours.

DISCLAIMER

- EVERLIGHT reserves the right(s) on the adjustment of product material mix for the specification.
- The product meets EVERLIGHT published specification for a period of twelve (12) months from date of shipment.
- The graphs shown in this datasheet are representing typical data only and do not show guaranteed values.
- When using this product, please observe the absolute maximum ratings and the instructions for using outlined in these specification sheets. EVERLIGHT assumes no responsibility for any damage resulting from the use of the product which does not comply with the absolute maximum ratings and the instructions included in these specification sheets.
- These specification sheets include materials protected under copyright of EVERLIGHT. Reproduction in any form is prohibited without obtaining EVERLIGHT's prior consent.
- This product is not intended to be used for military, aircraft, automotive, medical, life sustaining or life saving applications or any other application which can result in human injury or death. Please contact authorized EVERLIGHT sales agent for special application request.