

ROCKER/PADLE

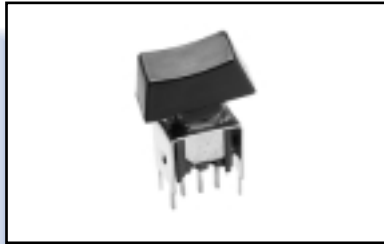

TRD Series - Page E3



TR Series - Page E7



A Series - Page E8

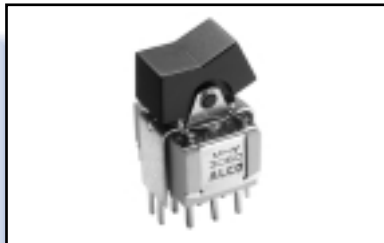

MHV Series - Page E22



XR Series - Page E26



XRL Series - Page E27



XRMQ Series - Page E29

Rocker/Paddle Part Number Index

A1/A2 MATRIX	Page 12
A101J1AQ0	Page 10
A101J1AV2Q0	Page 9
A101J1CQ0	Page 9
A101J1ZQ0	Page 10
A101J2AV2Q0	Page 11
A101J2CQ0	Page 11
A101J2ZQ0	Page 8
A101JA2Q0	Page 8
A103J1AQ0	Page 10
A103J1AV2Q0	Page 9
A103J1CQ0	Page 9
A103J1ZQ0	Page 10
A103J2AV2Q0	Page 11
A103J2CQ0	Page 11
A103J2ZQ0	Page 8
A103JA2Q0	Page 8
A105J1AQ0	Page 10
A105J1AV2Q0	Page 9
A105J1CQ0	Page 9
A105J1ZQ0	Page 10
A105J2AV2Q0	Page 11
A105J2CQ0	Page 11
A105J2ZQ0	Page 8
A105JA2Q0	Page 8
A107J1AQ0	Page 10
A107J1AV2Q0	Page 9
A107J1CQ0	Page 9
A107J1ZQ0	Page 10
A107J2AV2Q0	Page 11
A107J2CQ0	Page 11
A107J2ZQ0	Page 8
A107JA2Q0	Page 8
A108J1AQ0	Page 10
A108J1ZQ0	Page 10
A108J2AV2Q0	Page 11
A108J2CQ0	Page 11
A108J2ZQ0	Page 8
A108JA2Q0	Page 8
A201J1AQ0	Page 10
A201J1AV2Q0	Page 9
A201J1CQ0	Page 9
A201J1ZQ0	Page 10
A201J2AV2Q0	Page 11
A201J2CQ0	Page 11
A201J2ZQ0	Page 8
A201JA2Q0	Page 8
A203J1AQ0	Page 10
A203J1AV2Q0	Page 9
A203J1CQ0	Page 9
A203J1ZQ0	Page 10
A203J2AV2Q0	Page 11
A203J2CQ0	Page 11
A203J2ZQ0	Page 8
A203JA2Q0	Page 8
A205J1AQ0	Page 10
A205J1AV2Q0	Page 9
A205J1CQ0	Page 9
A205J1ZQ0	Page 10
A205J2AV2Q0	Page 11
A205J2CQ0	Page 11
A205J2ZQ0	Page 8
A205JA2Q0	Page 8
A207J1AQ0	Page 10
A207J1AV2Q0	Page 9

A207J1CQ0	Page 9
A207J1ZQ0	Page 10
A207J2AV2Q0	Page 11
A207J2CQ0	Page 11
A207J2ZQ0	Page 8
A207JA2Q0	Page 8
A208J1AQ0	Page 10
A208J1AV2Q0	Page 9
A208J1ZQ0	Page 10
A208J2AV2Q0	Page 11
A208J2CQ0	Page 11
A208J2ZQ0	Page 8
A208JA2Q0	Page 8
AE1/AE2 MATRIX	Page 18
MHV106DPC10(*)	Page 22
MHV106DPC20(*)	Page 22
MHV106EPC20(*)	Page 22
MHV106FPC10(*)	Page 22
MHV106FPC20(*)	Page 22
MHV206NPC10(*)	Page 22
MHV206NPC20(*)	Page 22
MHV206PPC20(*)	Page 22
MHV206RPC10(*)	Page 22
MHV206RPC20(*)	Page 22
MHV306DPC20(*)	Page 23
MHV306DPC10(*)	Page 23
MHV306FPC10(*)	Page 23
MHV306FPC20(*)	Page 23
MHV406FPC10(*)	Page 23
MHV406NPC10(*)	Page 23
MHV406NPC20(*)	Page 23
MHV406RPC20(*)	Page 23
MRV106DPC30(*)	Page 24
MRV106DPC40(*)	Page 24
MRV106EPC30(*)	Page 24
MRV106EPC40(*)	Page 24
MRV106FPC30(*)	Page 24
MRV106FPC40(*)	Page 24
MRV206NPC30(*)	Page 24
MRV206NPC40(*)	Page 24
MRV206PPC30(*)	Page 24
MRV206PPC40(*)	Page 24
MRV206RPC30(*)	Page 24
MRV206RPC40(*)	Page 24
MRV306DPC30(*)	Page 25
MRV306DPC40(*)	Page 25
MRV406NPC30(*)	Page 25
MRV406NPC40(*)	Page 25
TR11DGPCV1(*)	Page 7
TR11DGRA(*)	Page 7
TR11EGPCV1(*)	Page 7
TR11EGRA(*)	Page 7
TR11FGPCV1(*)	Page 7
TR11FGRA(*)	Page 7
TR21NGPCV1(*)	Page 7
TR21NGRA(*)	Page 7
TR21PGPCV1(*)	Page 7
TR21PGRA(*)	Page 7
TR21RGPCV1(*)	Page 7
TR21RGRA(*)	Page 7
TRD11D1(*)WL	Page 3
TRD11D10WLLR(*)	Page 3
TRD11E1(*)WL	Page 3
TRD11E10WLLR(*)	Page 3

TRD11F1(*)WL	Page 3
TRD11F10WLLR(*)	Page 3
TRD13D1(*)WL	Page 3
TRD13D10WLLR(*)	Page 3
TRD13E1(*)WL	Page 3
TRD13E10WLLR(*)	Page 3
TRD13F1(*)WL	Page 3
TRD13F10WLLR(*)	Page 3
TRD13N1(*)WL	Page 3
TRD21N1(*)WL	Page 3
TRD21P1(*)WL	Page 3
TRD21R1(*)WL	Page 3
TRD23D1(*)WL	Page 3
TRD23P1(*)WL	Page 3
TRD23R1(*)WL	Page 3
XR110A	Page 26
XR110D	Page 26
XR110E	Page 26
XR110F	Page 26
XR116A00+01	Page 28
XR116A00-2+01	Page 28
XR116A00-2+ON-OFF	Page 28
XR116A00-5+01	Page 28
XR116A00+ON-OFF	Page 28
XR116A002	Page 28
XR116A02+01	Page 28
XR116A02+ON-OFF	Page 28
XR116A029	Page 28
XR116A09+01	Page 28
XR116A09+ON-OFF	Page 28
XR116A092	Page 28
XR210K	Page 26
XR210N	Page 26
XR210P	Page 26
XR210R	Page 26
XRL110A	Page 27
XRL210A	Page 27
XRL210D	Page 27
XRL210F	Page 27
XRM110D(*)	Page 28
XRM110D(*)+01	Page 28
XRM110F(*)	Page 28
XRM210N(*)	Page 28
XRM210N(*)+0	Page 28
XRM210R(*)	Page 28
XRMQ10800	Page 29
XRMQ108A00+01	Page 29
XRMQ108A00-5+01	Page 29
XRMQ108A02	Page 29
XRMQ108A02+01	Page 29
XRMQ208K00	Page 29
XRMQ208K00+01	Page 29
XRMQ208K00-5+01	Page 29
XRMQ208K02	Page 29
XRMQ208K02+01	Page 29
XRMQ208K02-ON-OFF	Page 29
XRMQ208N00	Page 29
XRMQ208N00+01	Page 29

(*) Specify Color Choice Where Available
 (0) Black, (2) Red, (3) Orange,
 (4) Yellow, (5) Green, (6) Blue
 (8) Gray, (9) White
 (25) Red/Green Bi-Color

Rocker Switch TRD Series

For Additional Options Refer to Page E4-E6

MATERIAL SPECIFICATIONS:

Contacts Gold over nickel or silver plate
 Case Material Polyamide, black matte finish
 Actuator Material Polyamide
 Terminals/Fixed Contacts Copper alloy with gold or silver plate
 Terminal Seal Epoxy

ENVIRONMENTAL SPECIFICATIONS:

Operating Temperature -4°F to +176°F (-20°C to +80°C)
 Storage Temperature -49°F to +199°F (-45°C to +93°C)

TYPICAL PERFORMANCE CHARACTERISTICS:

Contact Rating 0.4 VA Max. @ 20 VDC or peak AC
 3 A @ 125 VAC or 28 VDC (2 pos.) 2A
 Initial Contact Resistance 20 Milliohms max.
 Contact Timing Break-before-make
 Insulation Resistance 1,000 Megohms min.
 Dielectric Strength 500 Volts RMS @ sea level
 Actuator Travel 23°
 Life Expectancy 2 Pos. - 100,000 actuations
 3 Pos. - 50,000 actuations
 UL recognized under the Component Program of Underwriters
 Laboratories Inc. File #E46765

NOTE: Part numbering sequence page E4

NOTE: When hand soldering, solder with switch in closed position.
 Solder temperature 550-600°F less than 5 seconds.

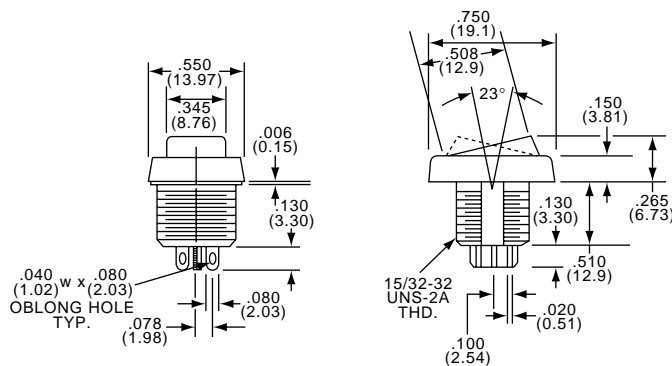

DPDT
 TRD21N10WL
 Standard Body Color - (Black)

Model	Type	Function	Act. Code Pg. M8	Contact	Terminal	Model	Type	Function	Act. Code Pg. M8	Contact	Terminal
TRD11D1(*)WL	SPDT	On None On	1	Gold	Wire Lug	TRD13D1(*)WL	SPDT	On None On	1	Silver	Wire Lug
TRD11E1(*)WL	SPDT	On Off On	5	Gold	Wire Lug	TRD13E1(*)WL	SPDT	On Off On	5	Silver	Wire Lug
TRD11F1(*)WL	SPDT	On None (On)	1	Gold	Wire Lug	TRD13F1(*)WL	SPDT	On None (On)	1	Silver	Wire Lug
TRD21N1(*)WL	DPDT	On None On	2	Gold	Wire Lug	TRD23N1(*)WL	DPDT	On None On	2	Silver	Wire Lug
TRD21P1(*)WL	DP3T	On Off On	6	Gold	Wire Lug	TRD23P1(*)WL	DP3T	On Off On	6	Silver	Wire Lug
TRD21R1(*)WL	DPDT	On None (On)	2	Gold	Wire Lug	TRD23R1(*)WL	DPDT	On None (On)	2	Silver	Wire Lug

(* Specify rocker color by adding suffix number: (0) Black (2) Red, (6) Blue (9) Yellow.
 (On) indicates momentary position.

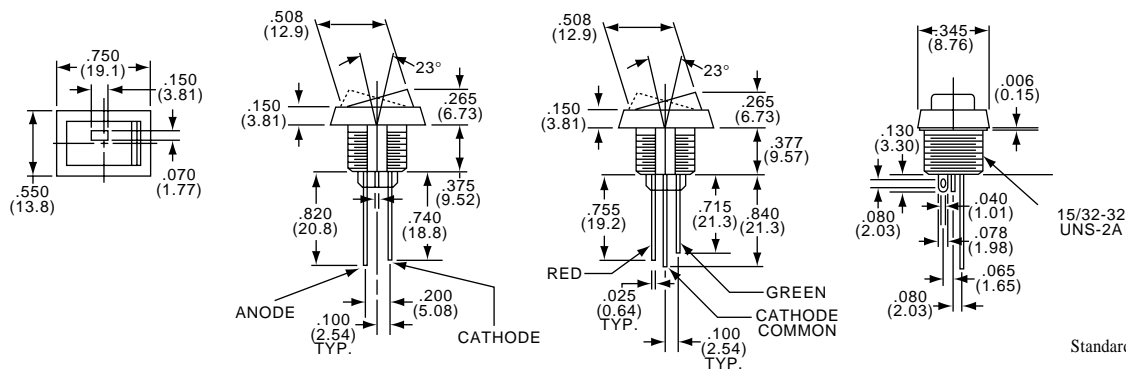

SPDT
 TRD11D10WLLR
 Standard Body and Rocker Color - (Black)

Model	Type	Function	Act. Code Pg. M8	Contact	Terminal	Model	Type	Function	Act. Code Pg. M8	Contact	Terminal
TRD11D10WLLR(*)	SPDT	On None On	1	Gold	Wire Lug	TRD13D10WLLR(*)	SPDT	On None On	1	Gold	Wire Lug
TRD11E10WLLR(*)	SP3T	On Off On	5	Gold	Wire Lug	TRD13E10WLLR(*)	SP3T	On Off On	5	Gold	Wire Lug
TRD11F10WLLR(*)	SPDT	On None (On)	1	Gold	Wire Lug	TRD13F10WLLR(*)	SPDT	On None (On)	1	Gold	Wire Lug

(* Specify LED color by adding suffix number: (2) Red, (4) Yellow, (5) Green, (25) Red/Green - Bi-color
 (On) indicates momentary position.

Need more technical information?
 Consult your Thomas & Betts
 sales office listed on the back cover

Thomas & Betts
 8155 T&B Blvd.
 Memphis, TN 38125
 (901) 252-5000 FAX (901) 252-1380

TRD Series *Rocker/Paddle • How To Order*

MATERIAL SPECIFICATIONS:

Movable Contacts Copper alloy w/silver inlay contact or gold plate
 Terminals/Fixed Contacts Copper alloy w/silver inlay contact or gold plate
 Terminal Seal Epoxy
 Housing/Beveled Frame Polyamide, black matte finish

ENVIRONMENTAL SPECIFICATIONS:

Operating Temperature -4°F to +176°F (-20°C to +80°C)
 Storage Temperature -49°F to +199°F (-45°C to +93°C)
 Solder Heat Resistance Meets MIL-STD-202, method 210

TYPICAL PERFORMANCE CHARACTERISTICS:

Contact Rating Silver: 3A max. @ 125 VAC, option 3
 Gold: 0.4VA max. @ 20 VDC, option 1
 Initial Contact Resistance 20 Milliohms max.
 Static Withstanding 15KV, per IEC 801-2
 Insulation Resistance 1,000 Megohms min. @ 500 VDC
 Dielectric Strength 500 Volts RMS @ sea level
 Electrical Life 2 Pos. 20K cycles @ full rated 3A load, 80K @ 0.4VA, 3 pos. 10K cycles @ full rated 3A load, 60K @ 0.4VA

***NOTICE: Caution should be used when hand-soldering. Solder heat Resistance -550°-600°F for less than 5 seconds. Solder with the switch in the closed position.**

UL recognized under the Component Program of Underwriters Laboratories Inc. File #E46765

HOW TO ORDER

See pages M2-M4 for application specific indexing.

E

Model	Contact Rating	Function	Actuator	Actuator Color	Terminal	Mount	L.E.D. Illumin.	L.E.D. Color	*UL
TRD1	Single Pole D on-on E on-off-on F on-(on) G (on)-off-(on) H on-off-(on) Double Pole N on-on P on-off-on R on-(on) S (on)-off-(on) T on-off-(on)		1 Rocker 2 Paddle	WL Wire Lug WW Wire Wrap QC Quick Connect PC Printed Circuit	15/32" round hole 5 1/2" square hole	L Beveled frame adaptor LR Integral w/rocker (TRD 1 only)		None Option L 2 red 4 yellow 5 green 25 bi-color red/green	Functions: Silver only D, F, N, & R Terminations Functions only WL, WW or QC only
Single Pole									
TRD2									
Double Pole									
1 Gold 0.4VA									
3 Silver 3A									
0 black									
2 red									
6 blue									
9 yellow									

ACTUATORS

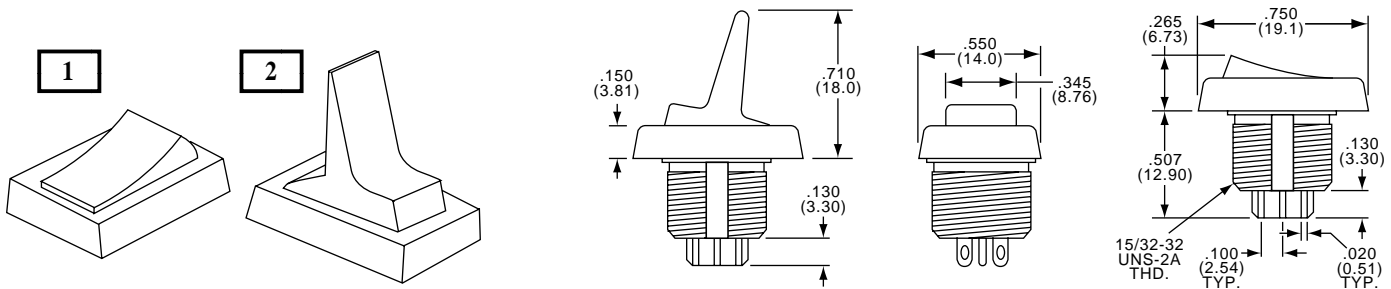

Thomas & Betts

Quality & Innovation From **AUGAT** Name Brand Products

E4

Thomas & Betts
 8155 T&B Blvd.
 Memphis, TN 38125
 (901) 252-5000 FAX (901) 252-1380

How To Order • Rocker/Paddle TRD Series

TERMINATIONS (Epoxy seal standard)

WL

Wire Lug

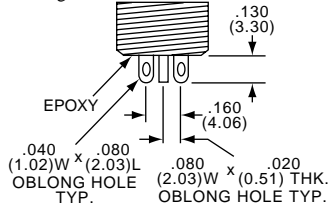

QC

Quick Connect
.110" (.020 thick)

Mates with standard
.110" female connectors

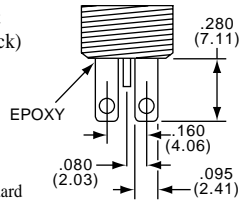

WW

Wire Wrap

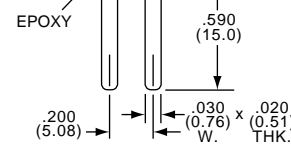

PC

Printed Circuit

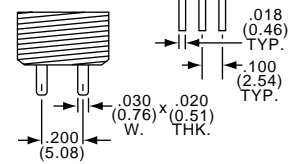

15/32" HOLE STANDARD

Standard TRD bushing will mount in any hole shown below.

Recommended panel thickness:
.030" to .250"

One hex nut, one internal tooth lock-washer supplied.

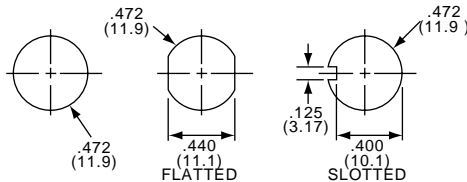

5

1/2" SQUARE CUTOUT SNAP-IN ADAPTOR

Recommended panel thickness:
.030" to .125"

Material: bright stainless steel
To specify adaptor separately, use P/N TRD10793

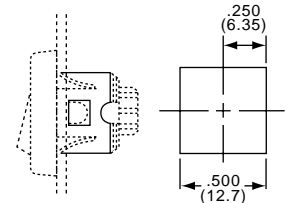

CONTACTS/RATING/UL RECOGNITION

1

0.4VA Max. @ 20 VDC

Movable Contact: Copper alloy, gold plate
Fixed Contact/Terminal: Copper alloy, gold plate

3

3A Max. @ 125 VAC

Movable Contact: Copper alloy, silver inlay
Fixed Contact/Terminal: Copper alloy, silver inlay

UL

For contact option 3
Rating: 3A, 120 VAC(Resistive)
File: E46765

Underwriters Laboratories, Inc. marking stamped under beveled frame.

L.E.D. ILLUMINATION - SINGLE AND BI-COLOR

LR

L.E.D. Integral
(Rocker Actuator)
All SPDT functions

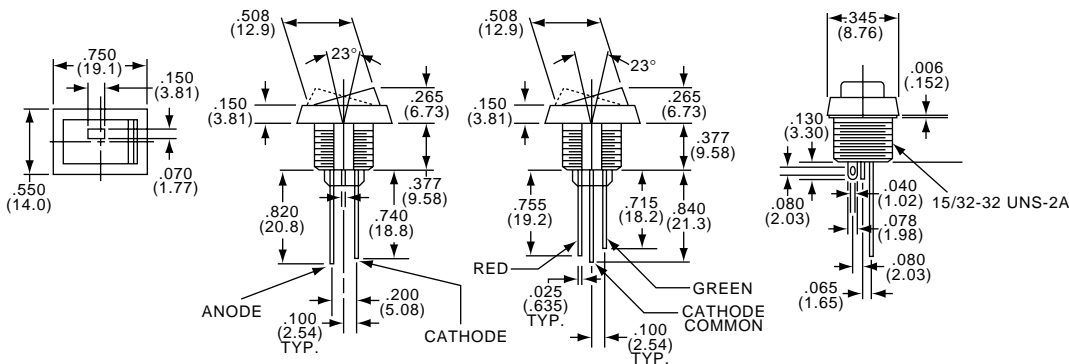

Standard mounting dimensions apply, L.E.D. supplied in **2** red, **4** yellow, **5** green, or **25** red/green.

L.E.D. Specifications: Max Voltage: 2.8 VDC

Max. Forward Current: red-20mA, Yellow-25 mA, green-25 mA, red/green-40 mA.

Need more technical information?

Consult your Thomas & Betts
sales office listed on the back cover

TRD Series *Rocker/Paddle • How To Order*

L L.E.D. BEVELE FRAME ADAPTOR (Accepts rectangular L.E.D.)

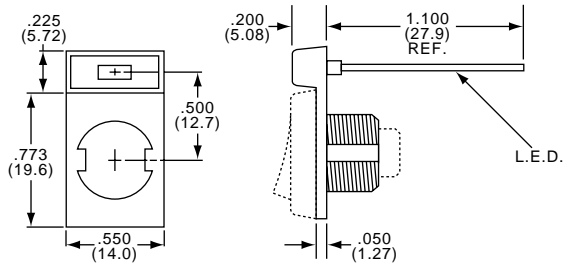

Material: Nylon 6/6
Color/Finish: Black, matte

MOUNTING

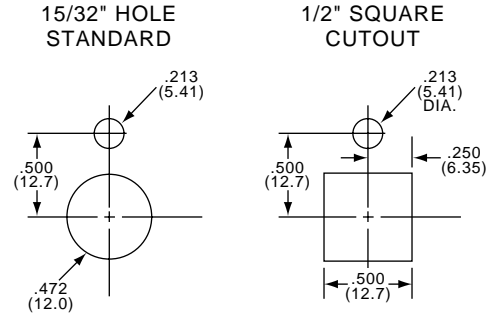

Recommended Panel Thickness: .030 to .220:

Recommended Panel Thickness: .030 to .095"

E FUNCTIONS

Single Pole	Double Pole	123 456	123 456	123 456
<input type="checkbox"/> D	<input type="checkbox"/> N	On	None	On
<input type="checkbox"/> E	<input type="checkbox"/> P	On	Off	On
<input type="checkbox"/> F	<input type="checkbox"/> R	On	None	(On)
<input type="checkbox"/> G	<input type="checkbox"/> S	(On)	Off	(On)
<input type="checkbox"/> H	<input type="checkbox"/> T	On	Off	(On)
SPDT Terminals Connected		2-3	---	1-2
DPDT Terminals Connected		2-3 5-6	---	1-2 4-5

- None** No mechanical position
- Off** Mechanical position, no electrical connection
- (On)** Momentary mechanical position, electrical connection

SWITCH GUARD

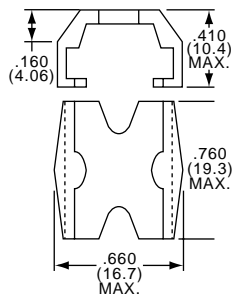
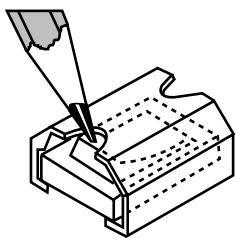

1. Insert switch in panel.
2. Attach lockwasher and hexnut.
3. Snap switch guard onto switch.
4. Tighten hex nut.

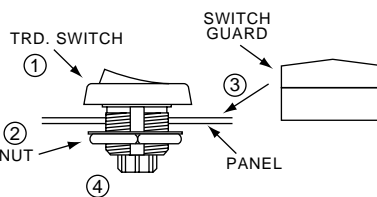

Recommended Panel Thickness:
 15/32" hole standard - .030 to .220
 15/32" square cutout - .030 to .095

Material: Nylon 6/6 **Color/Finish:** Black matte, Specify separately, P/N TRD10979

ROCKER BOOT SEAL

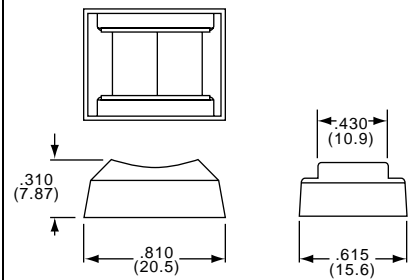

To specify boot seal use P/N TRD11494

Thomas & Betts

Quality & Innovation From **AUGAT**® Name Brand Products

E6

Thomas & Betts
 8155 T&B Blvd.
 Memphis, TN 38125
 (901) 252-5000 FAX (901) 252-1380

The Gemini Series "A" Series Paddles

Refer to Pages E12-E17 For Additional Options

MATERIAL SPECIFICATIONS:

Contacts/Terminals Gold/gold flash
 Silver/tin lead
 Case Material Thermoset 94V-0
 Actuator Material Polyamide
 Terminal Seal Epoxy

ENVIRONMENTAL SPECIFICATIONS:

Operating Temperature -4°F to +185°F (-20°C to +85°C)
 Storage Temperature -49°F to +212°F (-45°C to +100°C)

TYPICAL PERFORMANCE CHARACTERISTICS:

Contact Rating Gold: .04 VA @ 20 AC/DC
 Silver: 2 A @ 250 VAC: 5 A @ 125 VAC
 Initial Contact Resistance 30 Milliohms max.
 Contact Timing Break-before-make
 Insulation Resistance 1,000 Megohms @ 500 VDC
 Dielectric Strength 1,000 Volts RMS @ sea level
 Actuator Travel 25°
 Life Expectancy 30,000 Cycles

NOTE: Part numbering sequence page E12

SPDT

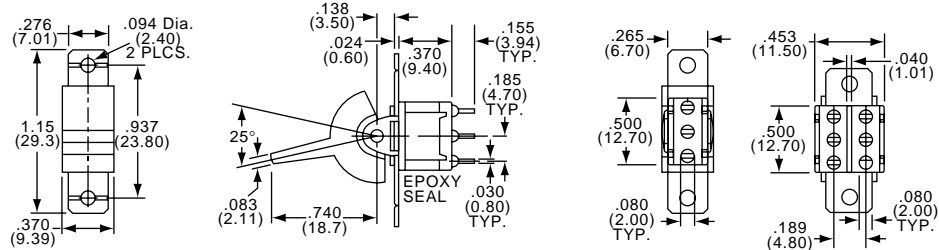

DPDT

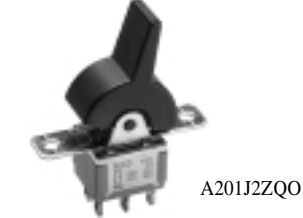

Standard Paddle Color - (Black)

Silver Contacts Model	Type	Act. Code	P. M8	↘	↓	↙	Silver Contacts Model	Type	Act. Code	P. M8	↘	↓	↙
A101J2ZQ0	SPDT	1	On	None	On		A201J2ZQ0	DPDT	2	On	None	On	
A103J2ZQ0	SPDT	5	On	Off	On		A203J2ZQ0	DPDT	6	On	Off	On	
A105J2ZQ0	SPDT	5	(On)	Off	(On)		A205J2ZQ0	DPDT	6	(On)	Off	(On)	
A107J2ZQ0	SPDT	5	On	Off	(On)		A207J2ZQ0	DPDT	6	On	Off	(On)	
A108J2ZQ0	SPDT	1	On	None	(On)		A208J2ZQ0	DPDT	2	On	None	(On)	

SPDT / DPDT

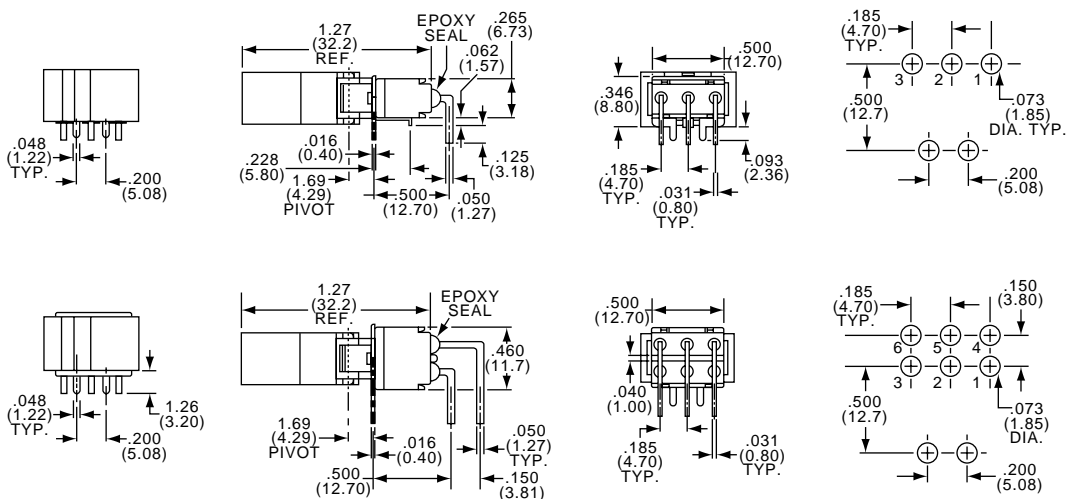

Standard Paddle Color - (Black)

Silver Contacts Model	Type	Act. Code	P. M8	↘	↓	↙	Silver Contacts Model	Type	Act. Code	P. M8	↘	↓	↙
A101J2AQ0	SPDT	1	On	None	On		A201J2AQ0	DPDT	2	On	None	On	
A103J2AQ0	SPDT	5	On	Off	On		A203J2AQ0	DPDT	6	On	Off	On	
A105J2AQ0	SPDT	5	(On)	Off	(On)		A205J2AQ0	DPDT	6	(On)	Off	(On)	
A107J2AQ0	SPDT	5	On	Off	(On)		A207J2AQ0	DPDT	6	On	Off	(On)	
A108J2AQ0	SPDT	1	On	None	(On)		A208J2AQ0	DPDT	2	On	None	(On)	

"A" Series Miniature Rockers
Refer to Page E12-E17 For Additional Options

The Gemini Series

SEE PAGE E8 FOR PRODUCT SPECIFICATIONS

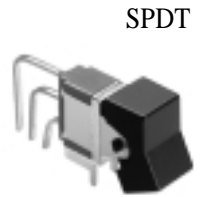
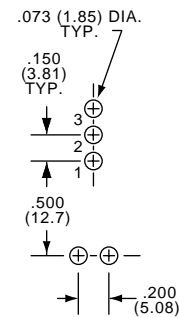
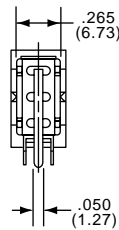
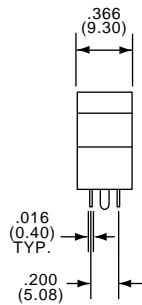
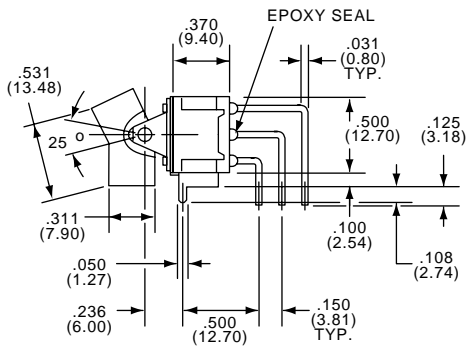

A101J1AV2Q0

DPDT

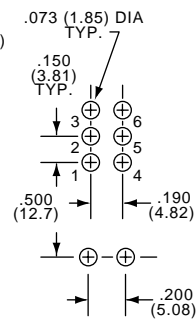
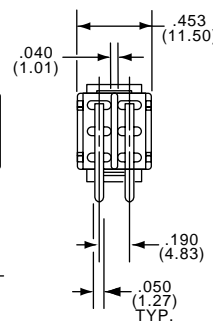
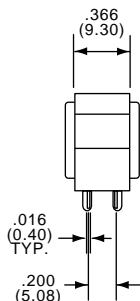

A205J1AV2Q0

Standard Rocker Color - (Black)

Silver Contacts Model	Type	Act. Code.	P. M8			
A101J1AV2Q0	SPDT	1	On	None	On	
A105J1AV2Q0	SPDT	5	(On)	Off	(On)	
A107J1AV2Q0	SPDT	5	On	Off	(On)	
A201J1AV2Q0	DPDT	2	On	None	On	
A205J1AV2Q0	DPDT	6	(On)	Off	(On)	
A208J1AV2Q0	DPDT	2	On	None	(On)	

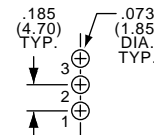
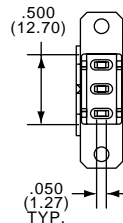
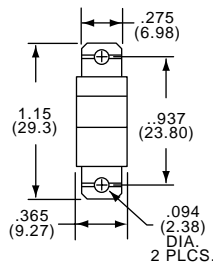
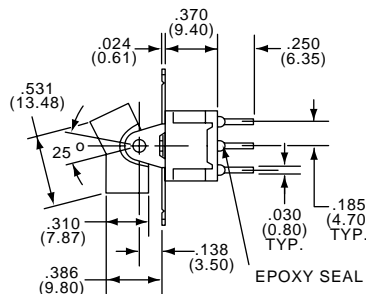

A101J1CQ0

SPDT

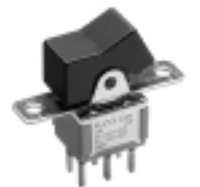
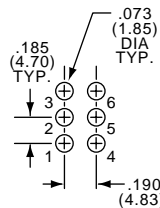
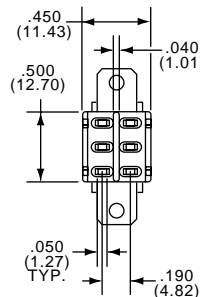
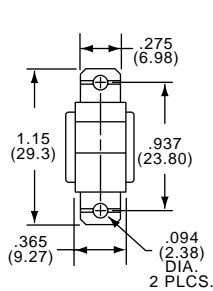

A201J1CQ0

DPDT

Standard Rocker Color - (Black)

Silver Contacts Model	Type	Act. Code.	P. M8			
A101J1CQ0	SPDT	1	On	None	On	
A105J1CQ0	SPDT	5	(On)	Off	(On)	
A201J1CQ0	DPDT	2	On	None	On	
A203J1CQ0	DPDT	6	On	Off	On	
A205J1CQ0	DPDT	6	(On)	Off	(On)	
A207J1CQ0	DPDT	6	On	Off	(On)	

Need more technical information?

Consult your Thomas & Betts sales office listed on the back cover

The Gemini Series "A" Series Miniature Rockers

Refer to Pages E12-E17 For Additional Options

SEE PAGE E8 FOR PRODUCT SPECIFICATIONS

SPDT



A101J1ZQO

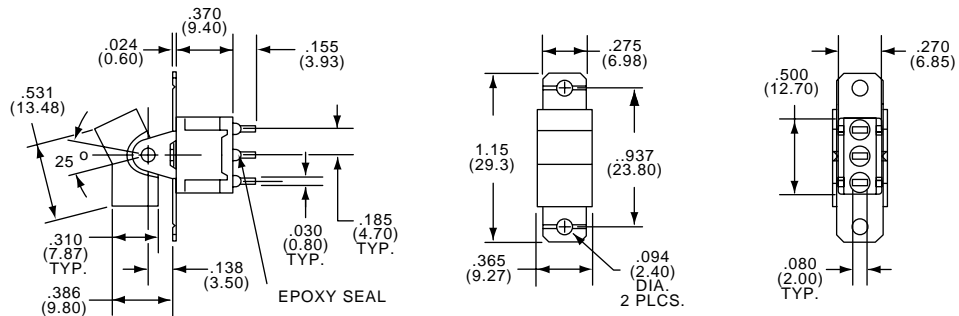

DPDT



A201J1ZQO

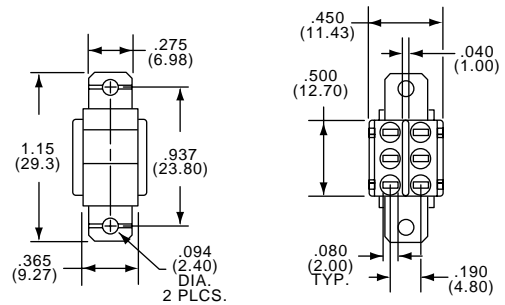

Standard Rocker Color - (Black)

Silver Contacts						Silver Contacts							
Model	Type	Act. Code.	P. M8				Model	Type	Act. Code.	P. M8			
A101J1ZQO	SPDT	1		On	None	On	A201J1ZQO	DPDT	2		On	None	On
A103J1ZQO	SPDT	5		On	Off	On	A203J1ZQO	DPDT	6		On	Off	On
A105J1ZQO	SPDT	5	(On)	Off	(On)		A205J1ZQO	DPDT	6	(On)	Off	(On)	
A107J1ZQO	SPDT	5		On	Off	(On)	A207J1ZQO	DPDT	6		On	Off	(On)
A108J1ZQO	SPDT	1		On	None	(On)	A208J1ZQO	DPDT	2		On	None	(On)

SPDT



A101J1AQO

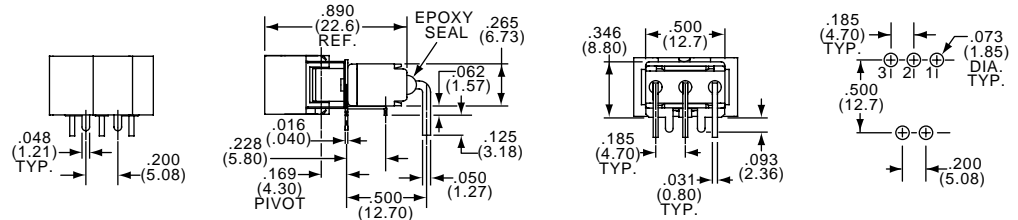

DPDT



A201J1AQO

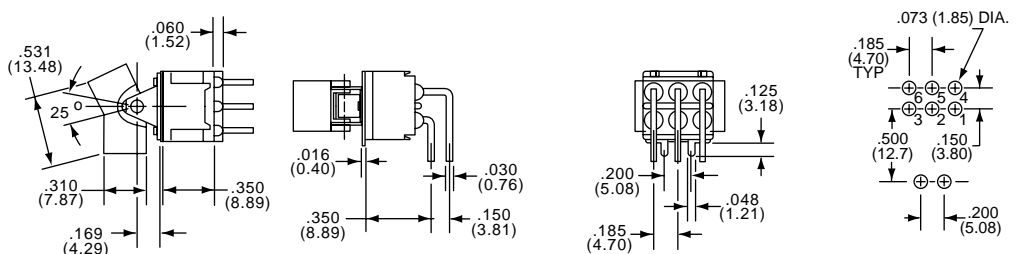

Standard Rocker Color - (Black)

Silver Contacts						Silver Contacts							
Model	Type	Act. Code.	P. M8				Model	Type	Act. Code.	P. M8			
A101J1AQO	SPDT	1		On	None	On	A201J1AQO	DPDT	2		On	None	On
A105J1AQO	SPDT	5	(On)	Off	(On)		A203J1AQO	DPDT	6		On	Off	On
A107J1AQO	SPDT	5		On	Off	(On)	A205J1AQO	DPDT	6	(On)	Off	(On)	

Thomas & Betts

Quality & Innovation From **AUGAT** Name Brand Products

E10

Thomas & Betts
8155 T&B Blvd.
Memphis, TN 38125
(901) 252-5000 FAX (901) 252-1380

"A" Series Paddles The Gemini Series

Refer to Page E12-E17 For Additional Options

SEE PAGE E8 FOR PRODUCT SPECIFICATIONS

SPDT / DPDT

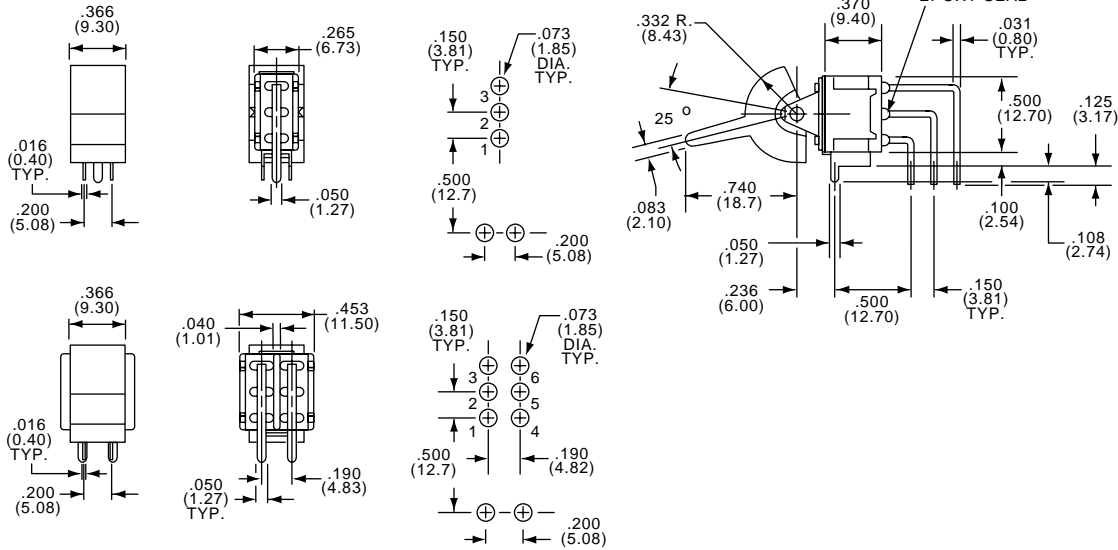

A105J2AV2Q0

Standard Paddle Color - (Black)

Silver Contacts Model	Type	Act. Code	P. M8	On	None	On	Silver Contacts Model	Type	Act. Code	P. M8	On	None	On
A101J2AV2Q0	SPDT	1		On	None	On	A201J2AV2Q0	DPDT	2		On	None	On
A105J2AV2Q0	SPDT	5		(On)	Off	(On)							

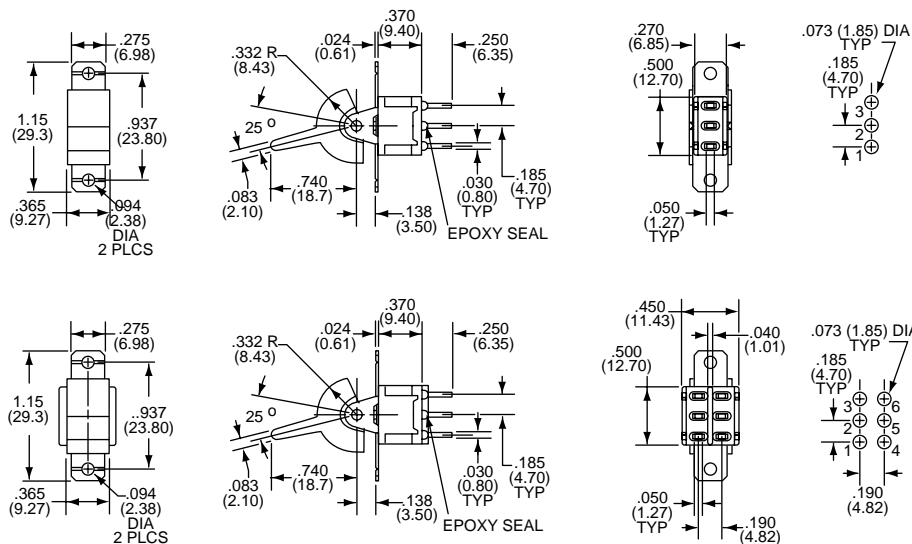

SPDT



A105J2CQ0

DPDT



A205J2CQ0

Silver Contacts Model	Type	Act. Code	P. M8	On	None	On	Silver Contacts Model	Type	Act. Code	P. M8	On	None	On
A105J2CQ0	SPDT	5		(On)	Off	(On)	A201J2CQ0	DPDT	2		On	None	On
							A205J2CQ0	DPDT	6		(On)	Off	(On)

Need more technical information?

Consult your Thomas & Betts sales office listed on the back cover



The Gemini Series "A" Series Miniature Rockers/Paddles

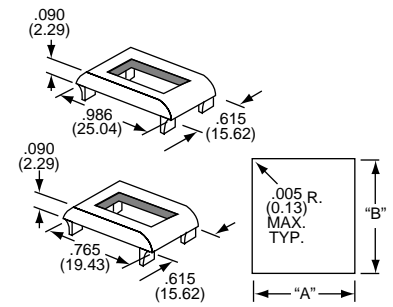

BEZELS FOR ROCKER AND PADDLE SWITCHES

Model	Panel Dimensions		(*) Specify Colors
	A	B	
B10(*)	.797-.803 (20.24)-(20.40)	.495-.505 (12.57)-(12.83)	(0) Black, (1) Brown, (2) Red, (3) Orange, (4) Yellow, (5) Green, (6) Blue, (8) Gray & (9) White
B20(*)	.595-.605 (15.11)-(15.37)	.495-.500 (12.57)-(12.70)	(0) Black, (1) Brown, (2) Red, (3) Orange, (4) Yellow, (5) Green, (6) Blue, (8) Gray & (9) White

DESIGN

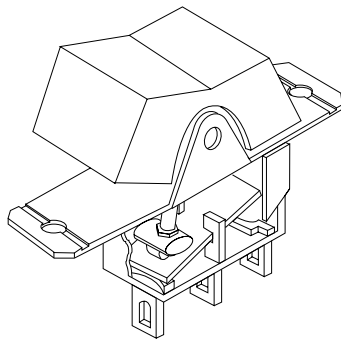

SP

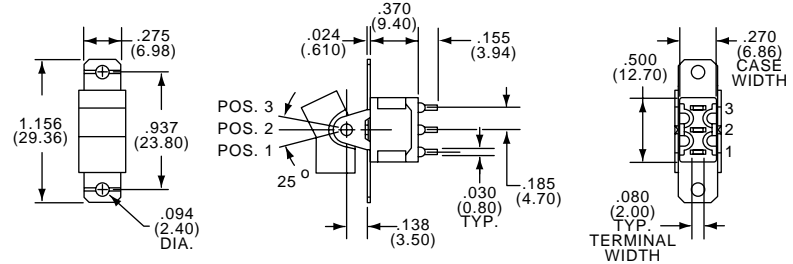

DP

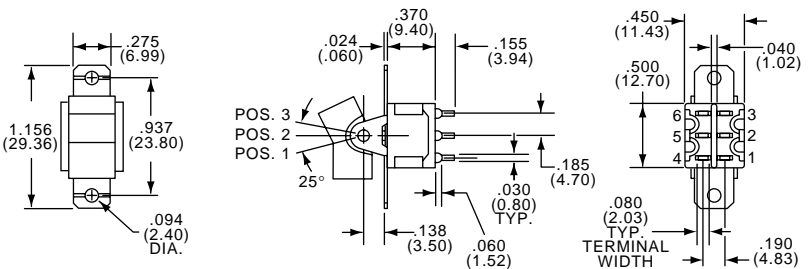

PART NUMBERING

Model	Function	Actuator	Terminal	Contact	Actuator Color	Beveled Frame Color	Option
A1	Single Pole	J1 Small	Z Wire Lug	Q Silver	0 Black (Std.)	0 Black (Std.)	UL (Q or G) contacts only
A2	Double Pole	J3 Large	A Right Angle	B Gold	1 Brown	1 Brown	
01	On-On	J15 Snap-in	AV2 Vert. Right Angle	G Gold over Silver	2 Red	2 Red	
03	On-Off-On	J16 Snap-in w/beveled frame	C Printed Circuit		3 Orange	3 Orange	
05	(On)-Off-(On)	J50 Snap-in	V5 Vertical Right Angle		4 Yellow	4 Yellow	
07	On-Off-(On)	J51 Snap-in w/beveled frame	V3 V4 V6 Vertical Support Bracket		5 Green	5 Green	
08	On-(On)	J52 Snap-in w/beveled frame LED	V7 V8 V9		6 Blue	6 Blue	
11	On-On-On		W W1 W3 W4 W5		8 Gray	8 Gray	
13	On-On-(On)	J2 Small	Z3 Quick Connect		9 White	9 White	
15	(On)-On-(On)	J4 Large					
		J5 Large					
		J60 Snap-in					
		J61 Snap-in w/beveled frame					
		J62 Snap-in w/beveled frame & LED					

OPTIONAL:

UL recognized under the Component Program of Underwriters Laboratories Inc. File # E46765
CSA Certified File #LR65901

See pages M2-M4 for application specific indexing.

"A" Series Miniature Rockers/Paddles The Gemini Series

FUNCTIONS

The following functions available in SP or DP.

01	2 Positions	None indicates no mechanical position
03	3 Positions	
05	3 Positions	Off indicates a mechanical position with no electrical connection.
07	3 Positions	
08	2 Positions	(On) indicates momentary action.

SPDT, connect terminals:

DPDT, connect terminals:

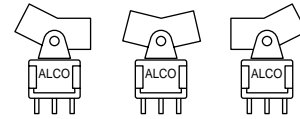

On None On

On Off On

(On) Off (On)

(On) Off On

(On) None On

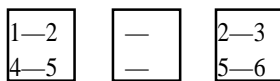
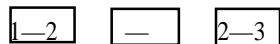

11 3 Positions

13 3 Positions

15 3 Positions

On On On

(On) On On

(On) On (On)

Functions available in DP only: Connect terminals:

SP3T Available in DP format only

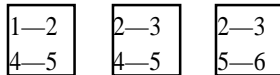

Wiring Diagram for Functions

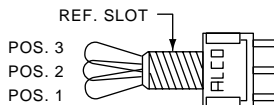

SINGLE POLE 3 POSITION

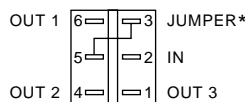

SP3T function achieved with external jumpers.
* Installed by Customer

POS. 1

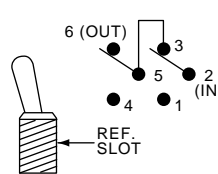

POS. 2

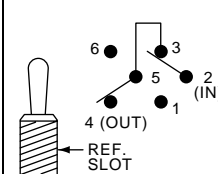

POS. 3

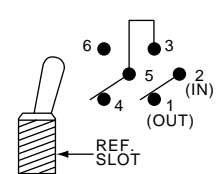

11 **13** **15**

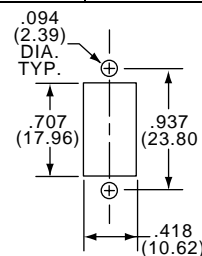
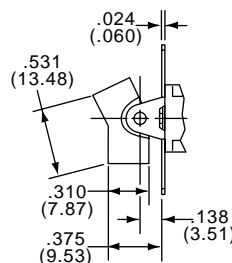
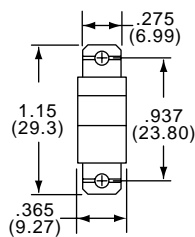

ACTUATORS

Rockers J1
Small

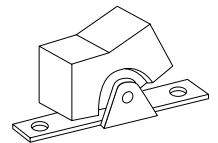

Use beveled frame B100 for enhancement (Pg.E12) when ordering with terminations other than C or Z.

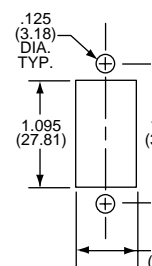
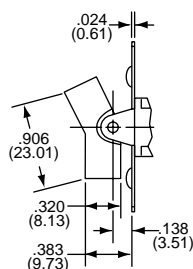
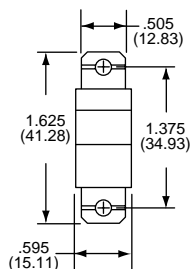

J3
Large

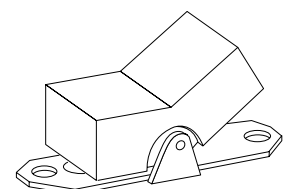

Need more technical information?

Consult your Thomas & Betts sales office listed on the back cover



The Gemini Series "A" Series Miniature Rockers/Paddles

ROCKER

J50

Snap-in

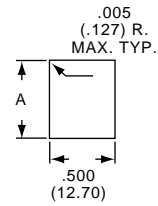
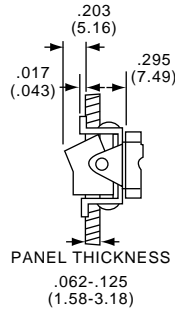
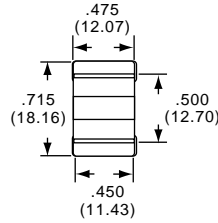
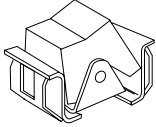

Use Beveled Frame B200 for enhancement (Pg. E12) when ordering with terminations other than C or Z.

	Panel Opening		
Panel Thickness	.062	.093	.125
"A"	.600-.605	.610-.615	.620-.625

J51

Snap-in with beveled frame

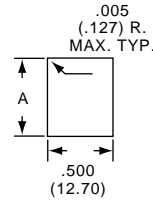
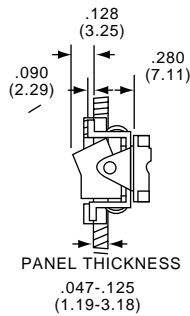
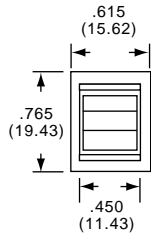
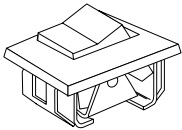

	Panel Opening		
Panel Thickness	.062	.093	.125
"A"	.600-.605	.610-.615	.620-.625

J52

Snap-in with beveled frame/L.E.D.

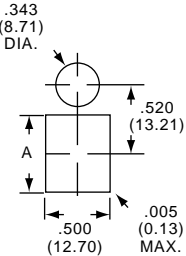
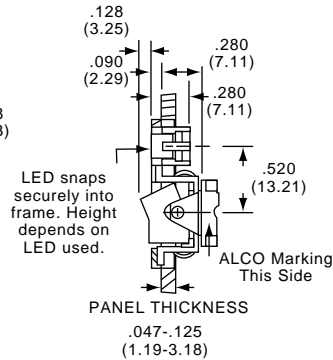
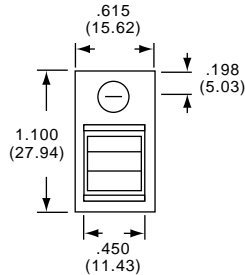
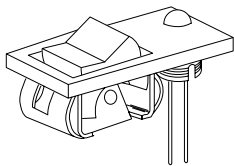

L.E.D. Not supplied.

Accepts BL-17 or equivalent LED

	Panel Opening		
Panel Thickness	.062	.093	.125
"A"	.600-.605	.610-.615	.620-.625

PADDLE

J2

Small

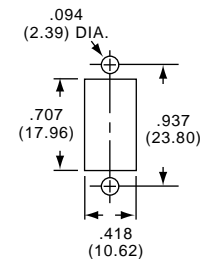
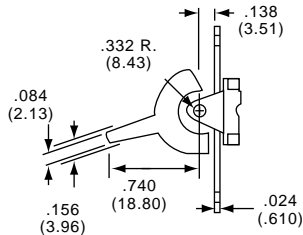
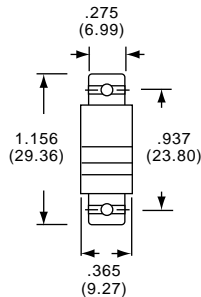
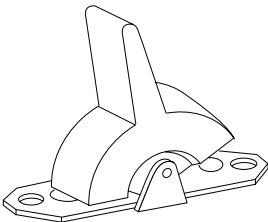

Use Beveled frame B100 for enhancement (Pg. E12) when ordering with terminations other than C or Z.

Thomas & Betts

Quality & Innovation From **AUGAT** Name Brand Products

E14

Thomas & Betts
8155 T&B Blvd.
Memphis, TN 38125
(901) 252-5000 FAX (901) 252-1380

"A" Series Miniature Rockers/Paddles The Gemini Series

J4
J5

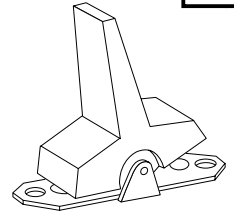
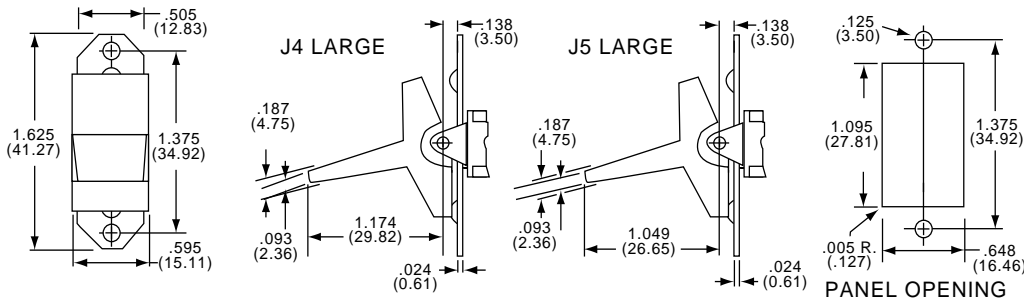

Snap-In **J15**

Snap-in with beveled frame **J16**

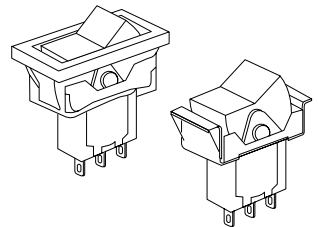
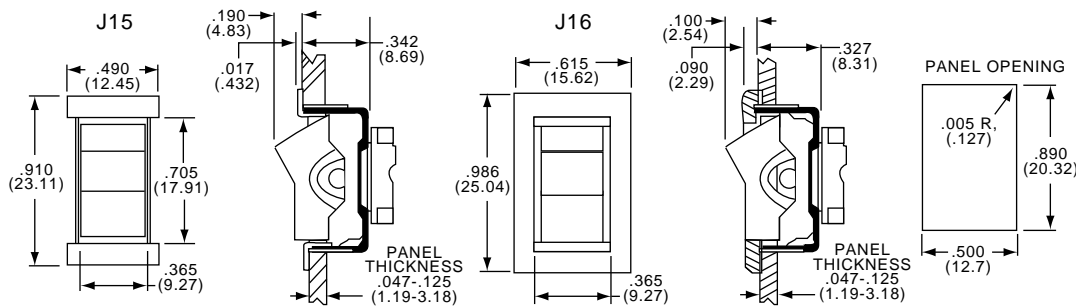

Snap-in **J60**

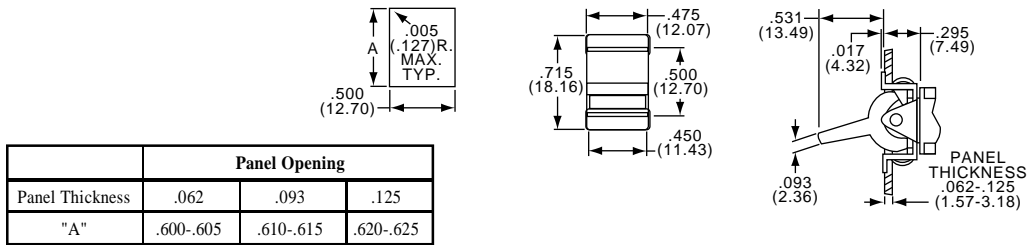

	Panel Opening		
Panel Thickness	.062	.093	.125
"A"	.600-.605	.610-.615	.620-.625

Use Beveled Frame B200 for enhancement (Pg. E12) when ordering with terminations other than C or Z.

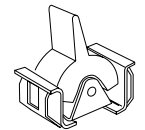

Snap-in with beveled frame **J61**

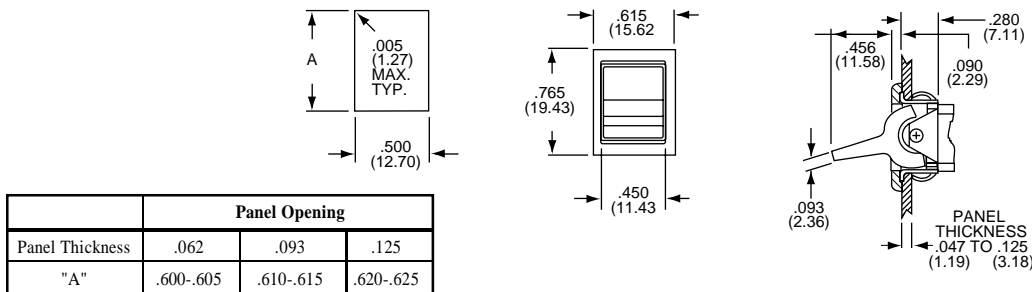

	Panel Opening		
Panel Thickness	.062	.093	.125
"A"	.600-.605	.610-.615	.620-.625

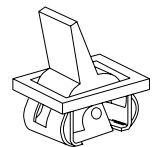

Snap-in with beveled frame/LED **J62**

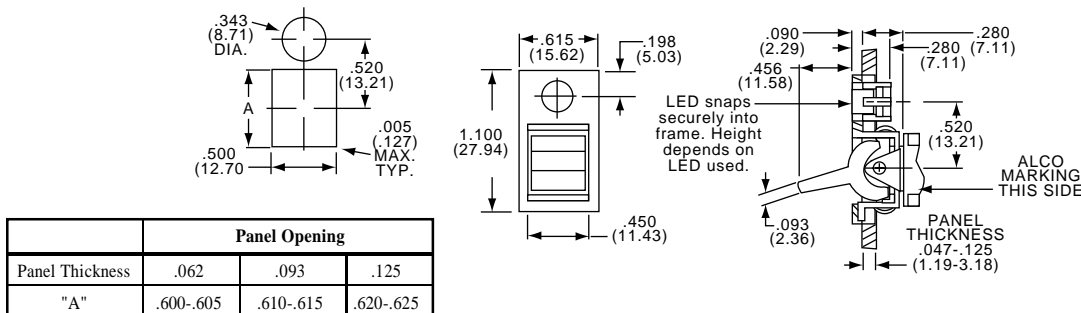

	Panel Opening		
Panel Thickness	.062	.093	.125
"A"	.600-.605	.610-.615	.620-.625

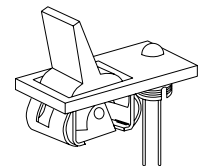

Accepts BL-17 or equivalent LED

Need more technical information?
Consult your Thomas & Betts sales office listed on the back cover

The Gemini Series "A" Series Miniature Rockers/Paddles

TERMINALS

Z
Wire Lug Standard

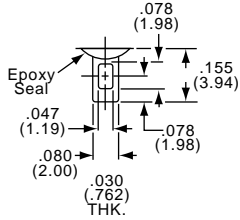

Z3
Quick Connect

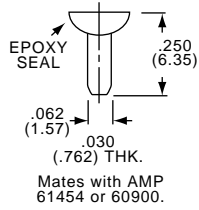

W W1 W3 W4 W5
Wire Wrap

	"A"
W	.750
W1	.964
W3	.425
W4	1.062
W5	1.305

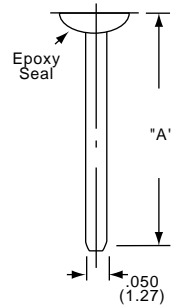

C
Printed Circuit

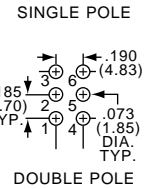
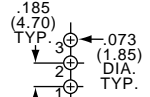
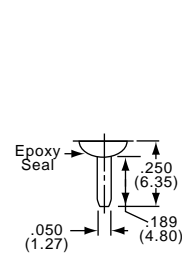

A
Right Angle
Single Pole

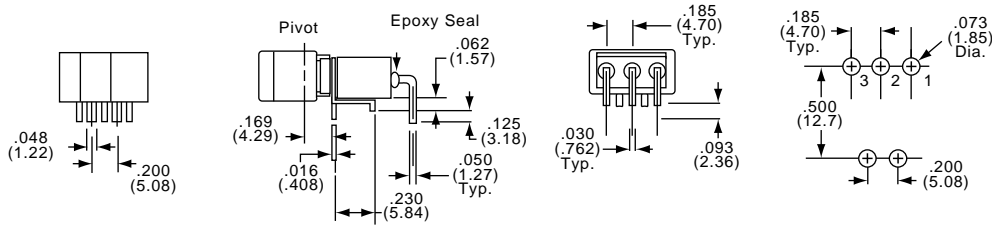

NOTE: Terminal numbers viewed from top of P.C. board.

**Right Angle
Double Pole**

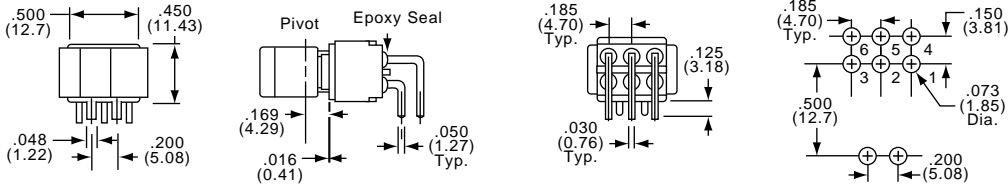

NOTE: Terminal numbers viewed from top of P.C. board.

AV2
Vertical Right Angle
Single Pole

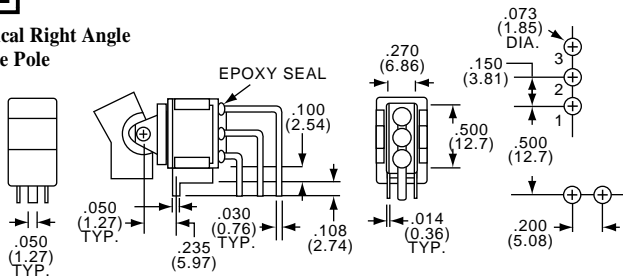

NOTE: Terminal numbers viewed from top of P.C. board.

V5

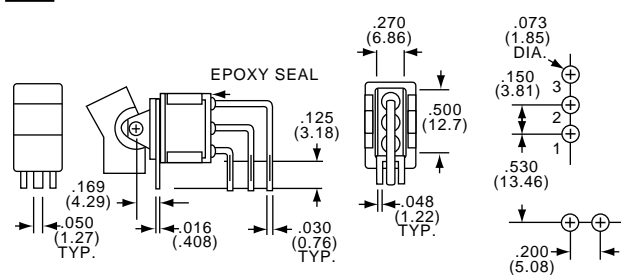

**Right Angle
Double Pole**

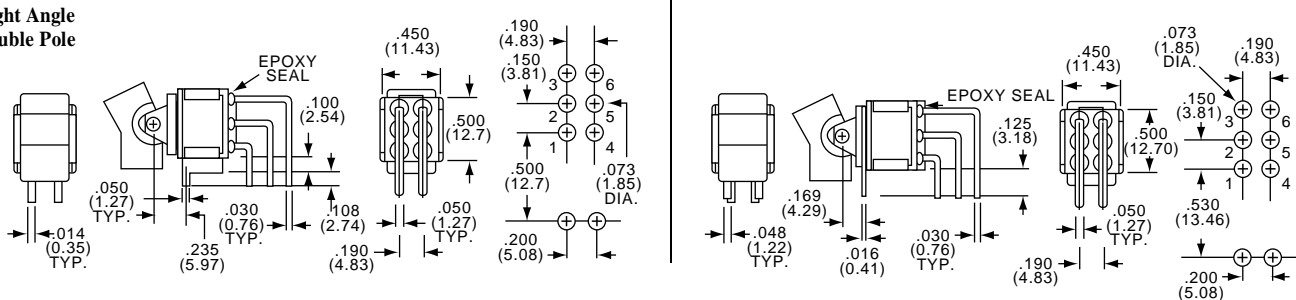

NOTE: Terminal numbers viewed from top of P.C. board.

Thomas & Betts

Quality & Innovation From **AUGAT** Name Brand Products

E16

Thomas & Betts
8155 T&B Blvd.
Memphis, TN 38125
(901) 252-5000 FAX (901) 252-1380

"A" Series Miniature Rockers/Paddles The Gemini Series

V3 V4 V9

**Vertical Support Bracket
Single Pole**

Option Code	Dim. "A"
V3	.460 (11.68)
V4	.630 (16.00)
V9	1.150 (29.21)

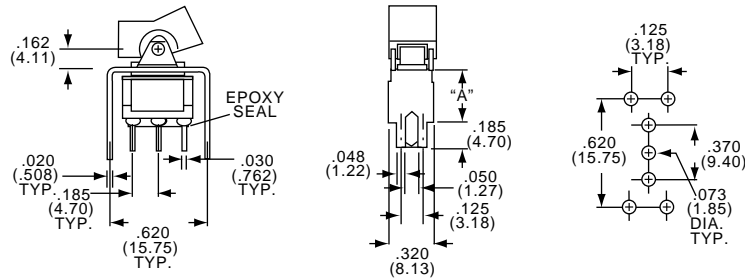

**Vertical Support Bracket
Double Pole**

Option Code	Dim. "A"
V3	.460 (11.68)
V4	.630 (16.00)
V9	1.150 (29.21)

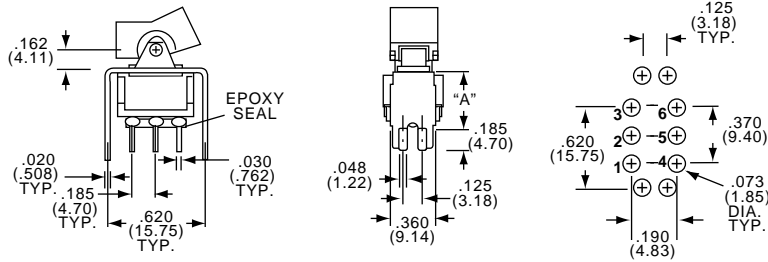

V6 V7 V8

**Vertical Support Bracket
Single Pole**

Option Code	Dim. "A"
V6	.460 (11.68)
V7	.630 (16.00)
V8	.953 (24.21)

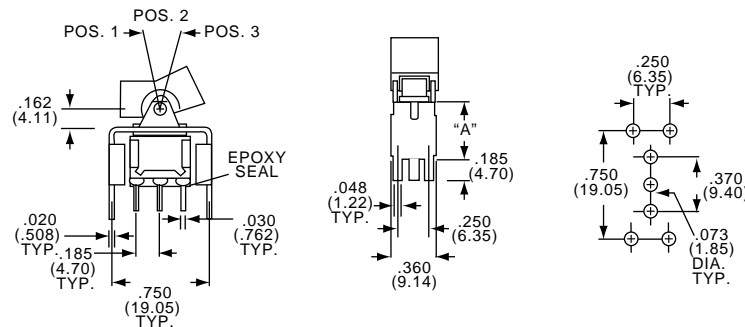

**Vertical Support Bracket
Double Pole**

Option Code	Dim. "A"
V6	.460 (11.68)
V7	.630 (16.00)
V8	.953 (24.21)

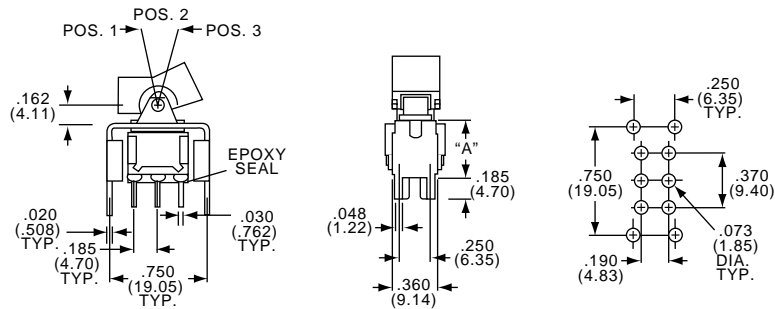

CONTACTS

B CONTACTS: Copper alloy with gold plate, welded button.

TERMINALS: Copper alloy with gold plate.

ELECTRICAL RATING: 0.4VA @ 20 VAC/DC.

Q CONTACTS: Copper alloy with silver, welded button.

TERMINALS: Copper alloy with tin/lead plate.

ELECTRICAL RATING: 5 A @ 125 VAC, 2 A @ 250 VAC, 5 A @ 28 VDC. UL/CSA RATING: 5A @ 125 VAC, 3 @ 250 VAC (Specify "UL" option code)

G CONTACTS: Copper alloy with gold plate over silver, welded button.

TERMINALS: Copper alloy with gold plate.

ELECTRICAL RATING: 0.4 VA @ 20 VAC/DC or 5 A @ 125 VAC, 2 A @ 250 VAC, 5 A @ 28 VDC.

Note: This contact option can be used for low-level or power switching. If level is above 0.4 VA @ 20 VAC/DC, the switch is rendered usable only for power switching due to arc-removal of gold plate.

UL/CSA RATING: 5A @ 125 VAC, 3 @ 250 VAC (Specify "UL" option code)

Need more technical information?

Consult your Thomas & Betts sales office listed on the back cover

The Gemini Series "AE" Series Washable Rockers/Paddles

MATERIAL SPECIFICATIONS:

Terminal Seal Epoxy (standard)
 Process Sealing Seals will withstand wave soldering and various subsequent cleaning operations.
 Contact/Terminals Gold/gold flash over tin/lead
 Silver/tin lead
 Case Material Thermoplastic
 Actuator Material Polyamide

ENVIRONMENTAL SPECIFICATIONS:

Operating Temperature -4°F to +185°F (-20°C to +85°C)
 Storage Temperature -49°F to +212°F (-45°C to +100°C)
 Meets MIL-STD-202, method 112C, Test Condition A & D 85°C.

TYPICAL PERFORMANCE CHARACTERISTICS:

Contact Rating Silver: 2 A @ 250 VAC, 5 A @ 125 VAC
 Gold: 0.4 VA @ 20 VDC max.
 Contact Resistance 30 Milliohms max. initial
 Insulation Resistance 1,000 Megohms min. @ 500 VDC.
 Dielectric Strength 1,000 Volts RMS @ sea level initial
 Static Withstanding 15KV Per IEC 801-2.
 Electrical Life 30,000 Cycles
 Actuator Travel 25°
 Contact Timing Break before make

DESIGN

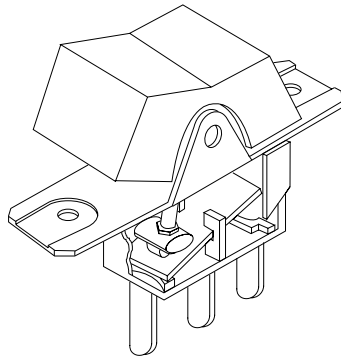

SP

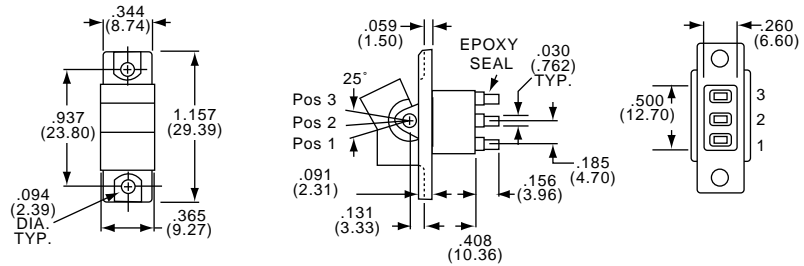

DP

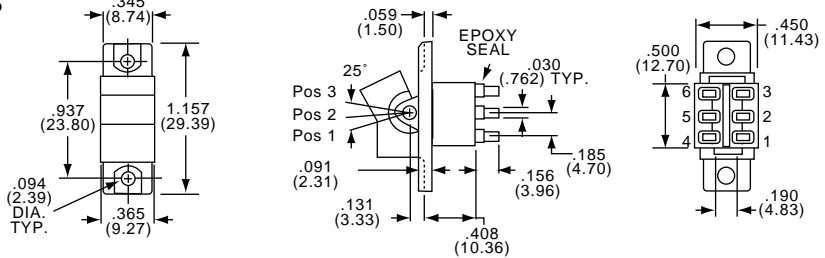

PART NUMBERING

Model	Function	Actuator	Terminal	Contact	Actuator Color	Option
AE1 Single Pole		Rocker	Z Wire Lug	B Gold	0 Black (Std.)	UL (Q or G) contacts only
AE2 Double Pole		J1 Standard	A Right Angle	Q Silver	1 Brown	
01 On-On		J50 Small	AV2 Vert. Right Angle	G Gold over Silver	2 Red	
03 On-Off-On		Paddle	C Printed Circuit		3 Orange	
05 (On)-Off-(On)		J2 Standard	V5 Vertical Right Angle		4 Yellow	
07 On-Off-(On)		J60 Small	V3 V3 Vertical Support Bracket		5 Green	
08 On-(On)			W W1 W3 W4 W5 Wire Wrap		6 Blue	
11 On-On-On			Z3 Quick Connect		8 Gray	
13 On-On-(On)					9 White	
15 (On)-On-(On)						

U.L. Available upon request

OPTIONAL:

UL recognized under the Component Program Underwriters Laboratories Inc. File #E46765
 CSA Certified File #LR65901

See pages M2-M4 for application specific indexing.

Thomas & Betts

Quality & Innovation From **AUGAT** Name Brand Products

E18

Thomas & Betts
 8155 T&B Blvd.
 Memphis, TN 38125
 (901) 252-5000 FAX (901) 252-1380

"AE" Series Washable Rockers/Paddles The Gemini Series

FUNCTIONS

The following functions available in SP or DP.

- 01** 2 Positions None indicates no mechanical position
- 03** 3 Positions
- 05** 3 Positions Off indicates a mechanical position with no electrical connection.
- 07** 3 Positions
- 08** 2 Positions (On) indicates momentary action.

SPDT, connect terminals:

DPDT, connect terminals:

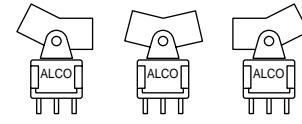

On None On

On Off On

(On) Off (On)

(On) Off On

(On) None On

1-2 — 2-3

1-2 — 2-3
4-5 — 5-6

On On On

(On) On On

(On) On (On)

11 3 Positions

13 3 Positions

15 3 Positions

Functions available in DP only: Connect terminals:

SP3T Available in DP Format Only

1-2 2-3 2-3
4-5 4-5 5-6

Wiring Diagrams for Functions

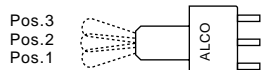

11 **13** **15**

SINGLE POLE 3 POSITION

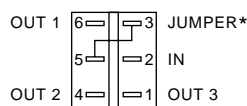

SP3T function achieved with external jumpers.

* Installed by Customer

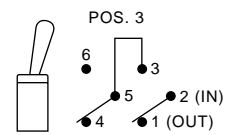
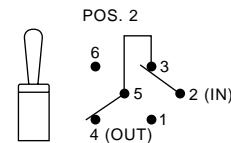
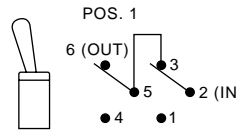

J1 Rocker

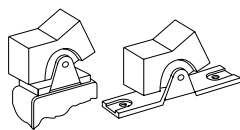

Use beveled frame B200 for enhancement (Pg. E12) when ordering with terminations other than C or Z.

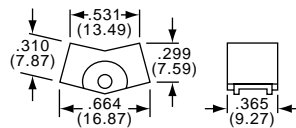

Unless otherwise specified by terminal type, the panel mounting bracket will be supplied.

Use beveled frame B100 for enhancement (Pg. E12) when ordering with terminations other than C or Z.

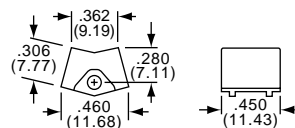

Unless otherwise specified by terminal type, the panel mounting bracket will be supplied.

ACTUATORS

J50

Rocker

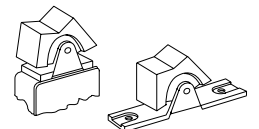

J2 Paddle

Paddle

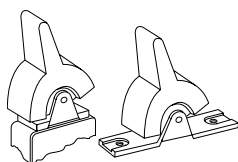

Use beveled frame B100 for enhancement (Pg. E12) when ordering with terminations other than C or Z.

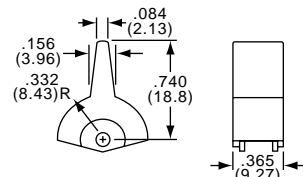

Unless otherwise specified by terminal type, the panel mounting bracket will be supplied.

Use beveled frame B200 for enhancement (Pg. E12) when ordering with terminations other than C or Z.

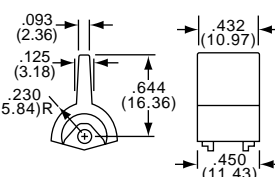

Unless otherwise specified by terminal type, the panel mounting bracket will be supplied.

J60

Paddle

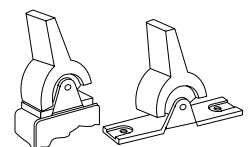

Need more technical information?

Consult your Thomas & Betts sales office listed on the back cover



The Gemini Series "AE" Series Washable Rockers/Paddles

TERMINALS

Z

Wire Lug

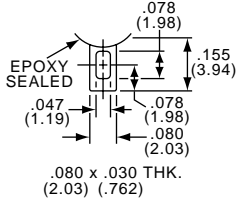

Z3

Quick Connect

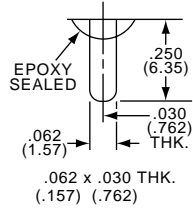

W

Wire Wrap

	"A"
W	.750
W1	.964
W3	.425
W4	1.062
W5	1.305

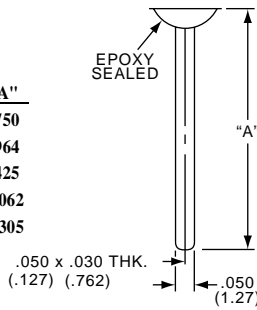

C

Printed Circuit

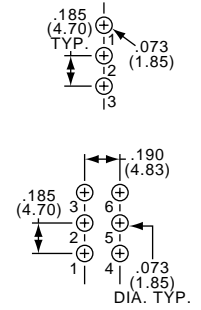
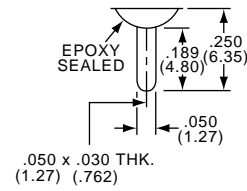

A

Right Angle
Single Pole

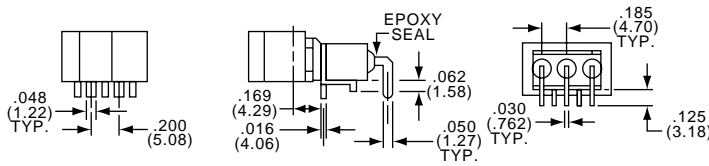

SINGLE POLE

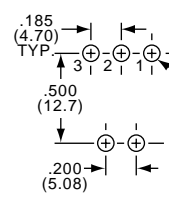

DOUBLE POLE

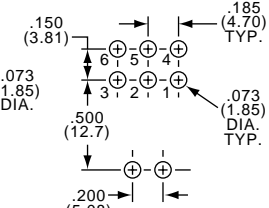

Right Angle
Double Pole

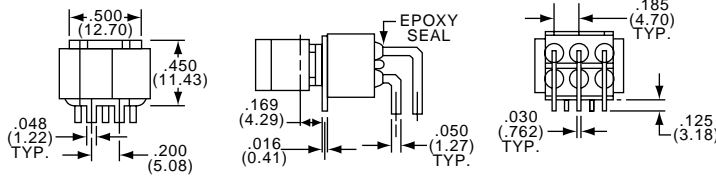

NOTE: Terminal numbers viewed from top of P.C. board.

AV2

Vertical
Right Angle

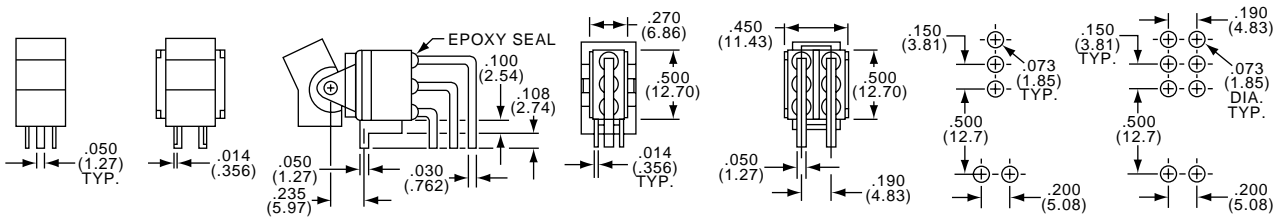

NOTE: Terminal numbers viewed from top of P.C. board.

V5

Vertical
Right Angle
Single Pole

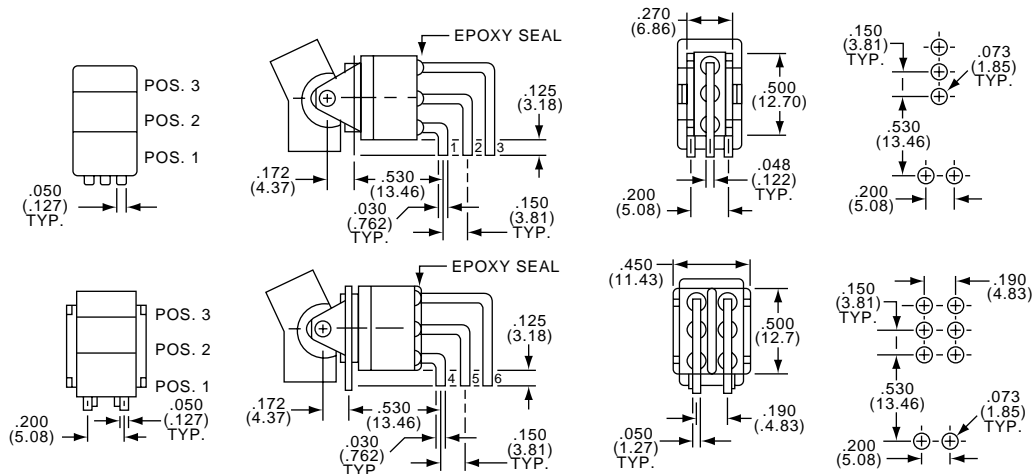

Vertical Right Angle
Double Pole

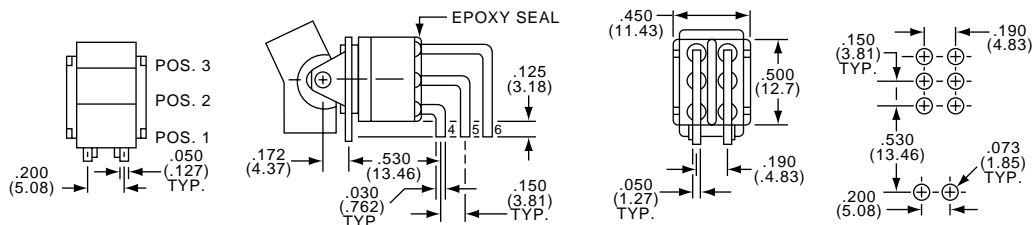

Thomas & Betts

Quality & Innovation From **AUGAT** Name Brand Products

E20

Thomas & Betts
8155 T&B Blvd.
Memphis, TN 38125
(901) 252-5000 FAX (901) 252-1380

"AE" Series Washable Rockers/Paddles The Gemini Series

V3 V4 V9

**Vertical Support Bracket
Single Pole**

Option Code	Dim. "A"
V3	.460 (11.68)
V4	.630 (16.00)
V9	1.150 (29.21)

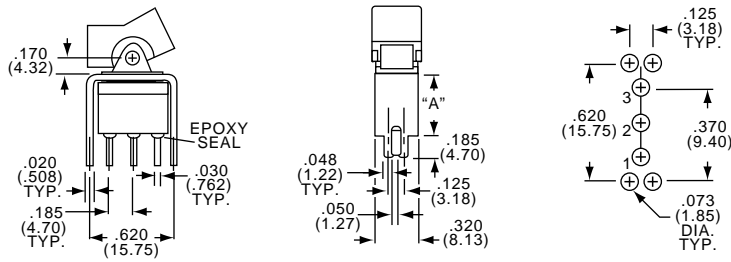

**Vertical Support Bracket
Double Pole**

Option Code	Dim. "A"
V3	.460 (11.68)
V4	.630 (16.00)
V9	1.150 (29.21)

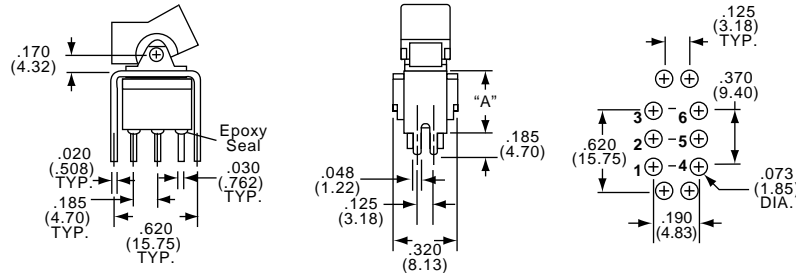

V6 V7 V8

**Vertical Support Bracket
Single Pole**

Option Code	Dim. "A"
V6	.460 (11.68)
V7	.630 (16.00)
V8	.953 (24.21)

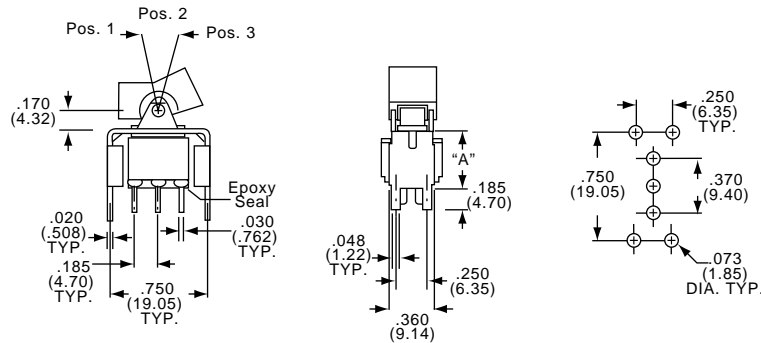

**Vertical Support Bracket
Double Pole**

Option Code	Dim. "A"
V6	.460 (11.68)
V7	.630 (16.00)
V8	.953 (24.21)

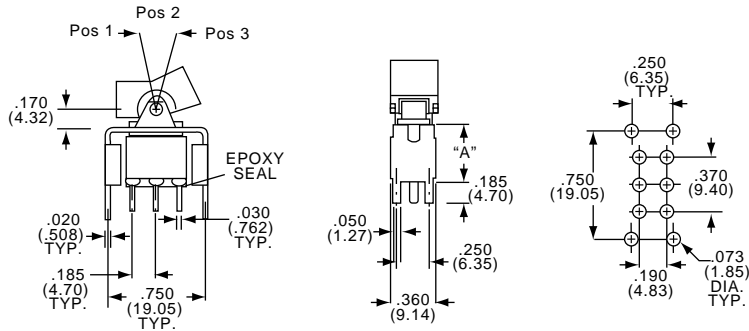

CONTACTS

B CONTACTS: Copper alloy with gold plate, welded button.

TERMINALS: Copper alloy with gold plate.

ELECTRICAL RATING: 0.4VA @ 20 VAC/DC.

Q CONTACTS: Copper alloy with silver, welded button.

TERMINALS: Copper alloy with tin/lead plate.

ELECTRICAL RATING: 5 amps @ 125 VAC, 2 amps @ 250 VAC, 5 amps @ 28 VDC.

UL/CSA RATING: 5A @ 125 VAC, 3 @ 250 VAC (Specify "UL" option code)

G CONTACTS: Copper alloy with gold plate over silver, welded button.

TERMINALS: Copper alloy with gold plate.

ELECTRICAL RATING: 0.4 VA @ 20 VAC/DC or 5 amps @ 125 VAC, 2 amps @ 250 VAC, 5 amps @ 28 VDC.

Note: This contact option can be used for low-level or power switching. If level is above 0.4 VA @ 20 VAC/DC, the switch is rendered usable only for power switching due to arc-removal of gold plate.

UL/CSA RATING: 5A @ 125 VAC, 3 @ 250 VAC (Specify "UL" option code)

Need more technical information?

Consult your Thomas & Betts sales office listed on the back cover

E21

Thomas & Betts
8155 T&B Blvd.
Memphis, TN 38125
(901) 252-5000 FAX (901) 252-1380

MHV Series *Mini Rocker & Paddle w/Vertical Support*



MATERIAL SPECIFICATIONS:

Contacts Gold flash over solid silver
 Case Material Thermoset 94V-0
 Actuator Material Polyamide
 Terminals Gold flash
 Terminal Seal Insert molded

ENVIRONMENTAL SPECIFICATIONS:

Operating Temperature -4°F to +176°F (-20°C to +80°C)
 Storage Temperature -40°F to -176°F (-40°C to +80°C)

TYPICAL PERFORMANCE CHARACTERISTICS:

Contact Rating 6 A @ 125 VAC, 3 A @ 250 VAC,
 4 A @ 28 VDC
 Initial Contact Resistance 10 Milliohms max.
 Contact Timing Break-before-make
 Insulation Resistance 1,000 Megohms min.
 Dielectric Strength 1,500 Volts RMS @ sea level
 Actuator Travel 24°
 Life Expectancy Actuation Code 1 - 80,000 Cycles

SPDT



MHV106DPC10M0

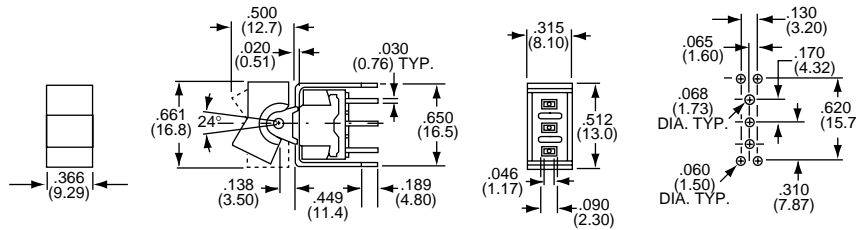

Model	Type	Act. Code	P. M8				Actuator Type
MHV106DPC10()(*)	SPDT	1		On	None	On	Rocker
MHV106FPC10()(*)	SPDT	1		On	None	(On)	Rocker
MHV206NPC10()(*)	DPDT	2		On	None	On	Rocker
MHV206RPC10()(*)	DPDT	2		On	None	(On)	Rocker

() Indicate M for Matte. Leave blank for glossy.
 (*) Specify color by adding suffix number: (0) Black, (2) Red, (5) Green, (6) Blue, (8) Grey, (9) White.
 (On) indicates momentary position.

DPDT



MHV206NPC20M2

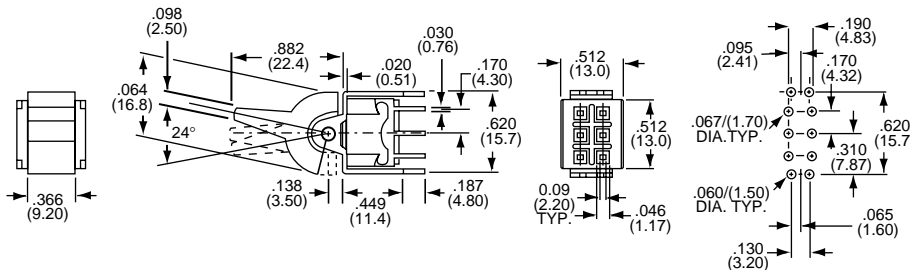

Model	Type	Act. Code	P. M8				Actuator Type
MHV106DPC20()(*)	SPDT	1		On	None	On	Paddle
MHV206NPC20()(*)	DPDT	2		On	None	On	Paddle

() Indicate M for Matte. Leave blank for glossy.
 (*) Specify color by adding suffix number: (0) Black, (2) Red, (5) Green, (6) Blue, (8) Grey, (9) White.

SEE PAGE E22 FOR PRODUCT SPECIFICATIONS

3PDT

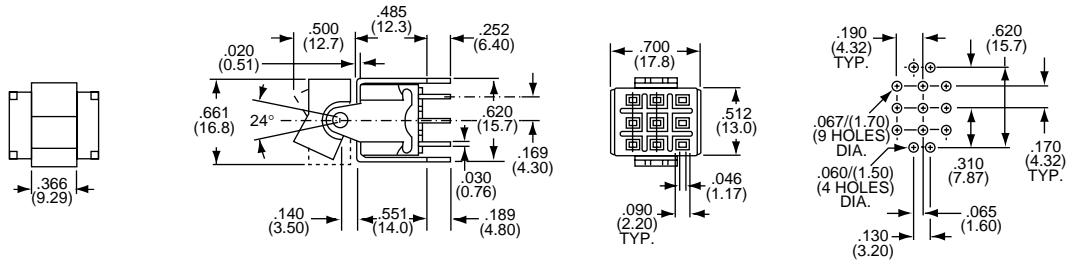

MHV30610M

E

Model	Type	Act. Code	P. M8				Actuator Type
MHV306DPC10()(*)	3PDT	3		On	None	On	Rocker
MHV406NPC10(*)	4PDT	4		On	None	On	Rocker

() Indicate M for Matte. Leave blank for glossy.
 (*) Specify color by adding suffix number: (0) Black, (2) Red, (5) Green, (6) Blue, (8) Grey, (9) White.

4PDT

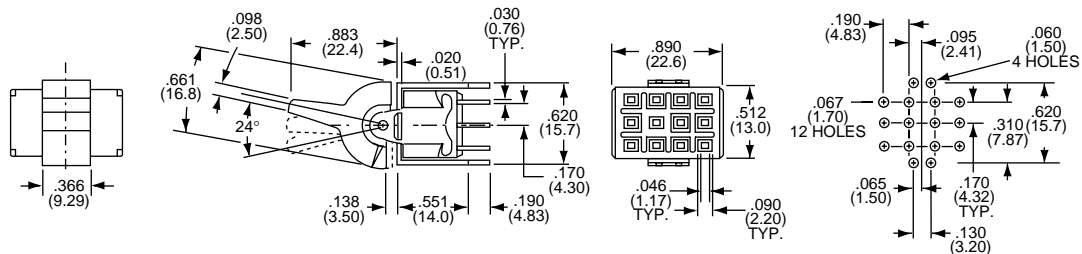

MHV406NPC20M

Model	Type	Act. Code	P. M8				Actuator Type
MHV306DPC20()(*)	3PDT	3		On	None	On	Paddle
MHV306FPC20()(*)	3PDT	3		On	None	(On)	Paddle
MHV406NPC20(*)	4PDT	4		On	None	On	Paddle

(On) indicates momentary position.
 () Indicate M for Matte. Leave blank for glossy.
 (*) Specify color by adding suffix number: (0) Black, (2) Red, (5) Green, (6) Blue, (8) Grey, (9) White.

Need more technical information?
 Consult your Thomas & Betts
 sales office listed on the back cover

MRV Series *Rocker & Paddle w/Vertical Support*



MATERIAL SPECIFICATIONS:

Contacts Copper with gold flash over silver
 Case Material Thermoset
 Actuator Material Polycarbonate resin
 Terminals Copper with gold flash
 Terminal Seal Insert molded

TYPICAL PERFORMANCE CHARACTERISTICS:

Contact Rating 6 A @ 125 VAC, 3 A @ 250 VAC,
 4 A @ 28 VDC
 Initial Contact Resistance 10 Milliohms max.
 Contact Timing Break-before-make
 Insulation Resistance 1,000 Megohms min.
 Dielectric Strength 1,500 Volts RMS @ sea level
 Actuation Force 0.05 to 1.5 Kg.
 Actuator Travel 24°

ENVIRONMENTAL SPECIFICATIONS:

Operating Temperature -4°F to +176°F (-20°C to +80°C)
 Storage Temperature -40°F to +176°F (-40°C to +80°C)

SPDT



MRV106DPC309

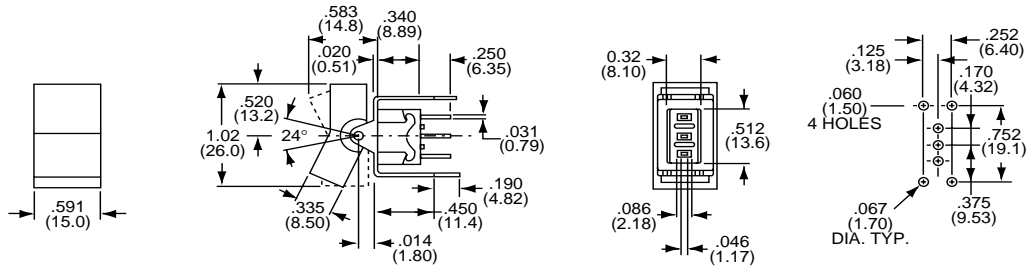

Model	Type	Act. Code	P. M8				Actuator Type
MRV106DPC30()(*)	SPDT	1		On	None	On	Rocker
MRV106FPC30()(*)	SPDT	1		On	None	(On)	Rocker
MRV206NPC30()(*)	DPDT	2		On	None	On	Rocker
MRV206PPC30()(*)	DPDT	6		On	Off	On	Rocker

() Indicate M for Matte. Leave blank for glossy.
 (*) Specify color by adding suffix number: (0) Black, (2) Red, (3) Orange (matte paddle only), (6) Blue (matte rocker only), (8) Grey, (9) White,
 (On) indicates momentary position.

DPDT



MRV206NPC40MO

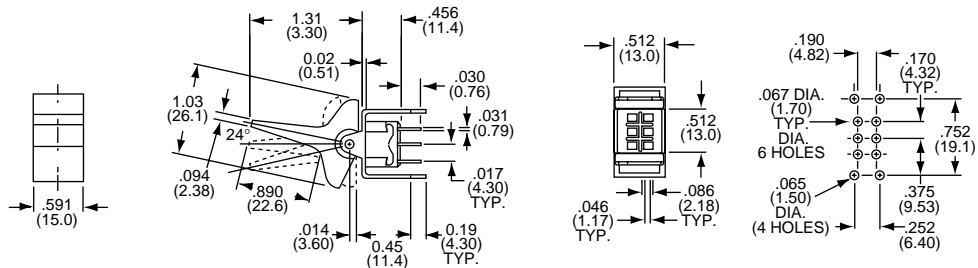

Model	Type	Act. Code	P. M8				Actuator Type
MRV206PPC40()(*)	DPDT	6		On	Off	On	Paddle

() Indicate M for Matte. Leave blank for glossy.
 (*) Specify color by adding suffix number: (0) Black, (2) Red, (3) Orange (matte paddle only), (6) Blue (matte rocker only), (8) Grey, (9) White,

SEE PAGE E24 FOR PRODUCT SPECIFICATIONS

3PDT

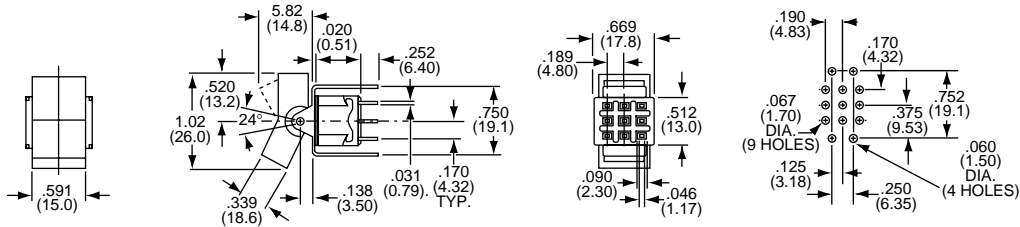

MRV306DPC30

Model	Type	Act. Code	P. M8				Actuator Type
MRV306DPC30(*)	3PDT	3		On	None	On	Rocker
MRV406NPC30(*)	4PDT	4		On	None	On	Rocker

() Indicate M for Matte Actuators. Leave blank for glossy.
 (*) Specify color by adding suffix number: (0) Black, (2) Red, (3) Orange (matte paddle only), (6) Blue (matte rocker only), (8) Grey, (9) White.

4PDT

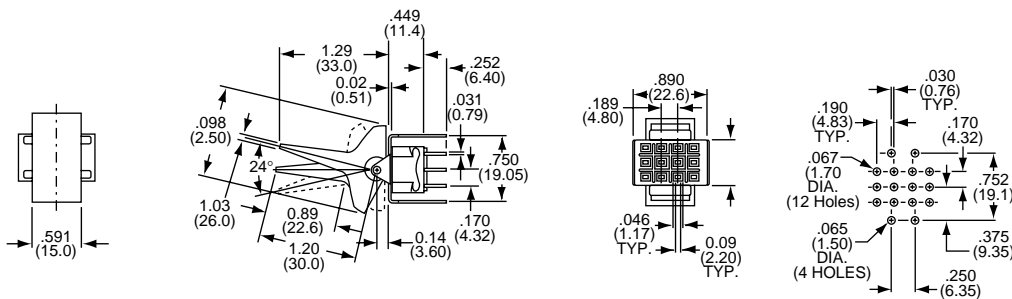

MRV406NPC40

Model	Type	Act. Code	P. M8				Actuator Type
MRV306DPC40(*)	3DPT	3		On	None	On	Paddle
MRV406NPC40(*)	4DPT	4		On	None	On	Paddle

() Indicate M for Matte Actuators. Leave blank for glossy.
 (*) Specify color by adding suffix number: (0) Black, (2) Red, (3) Orange (matte paddle only), (6) Blue (matte rocker only), (8) Grey, (9) White.

Need more technical information?

Consult your Thomas & Betts sales office listed on the back cover



XR Series *Snap-Mount Rocker "10 Amp"*

MATERIAL SPECIFICATIONS:

Case: Polyamide
 Actuator: Polyamide
 Contacts: Copper alloy
 Panel Accommodations030" to .250"
 Terminals Will accept .250" quick connect or solder

TYPICAL PERFORMANCE CHARACTERISTICS:

Contact Rating 10 A @ 125 VAC, 5 A @ 250 VAC
 Initial Contact Resistance 50 Milliohms max.
 Insulation Resistance 1,000 Megohms min.
 Life Expectancy Over 10,000 cycles
 UL File No. #E46765 and CSA Certified File #LR 75648

Color Ordering Information

Color Code	Body	Rocker
00	Black	Black
02	Black	Red
09	Black	White
90	White	Black
92	White	Red
94	White	Amber

Complete your model number by adding the desired 2-digit color code number.

EXAMPLE: XR110D09
 Body color: Black (0)
 Lever color: White (9)

SPST/SPDT

E



XR110A90+ONOFF



XR110E09

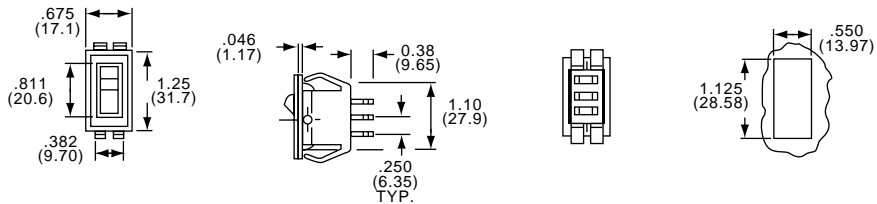

Model	Legend	Type	*Actuator Code	Color Codes
XR110A(**)	On/Off	SPST	51	On None Off 00, 02, 09, 90, 92
XR110D(**)	-01†	SPDT	52	On None On 00, 02, 09, 90, 92
XR110E(**)		SPDT	52	On Off On 00, 02, 09, 90, 92
XR110F(**)		SPDT	52	On None (On) 00, 02, 09, 90, 92

*See actuator code chart bottom of page (On) indicates momentary position.
 (**) Specify body and lever color by adding suffix number, see color ordering information top of page.
 †01 for international bar/circle imprint.

DPST/DPDT



XR210K09+ONOFF

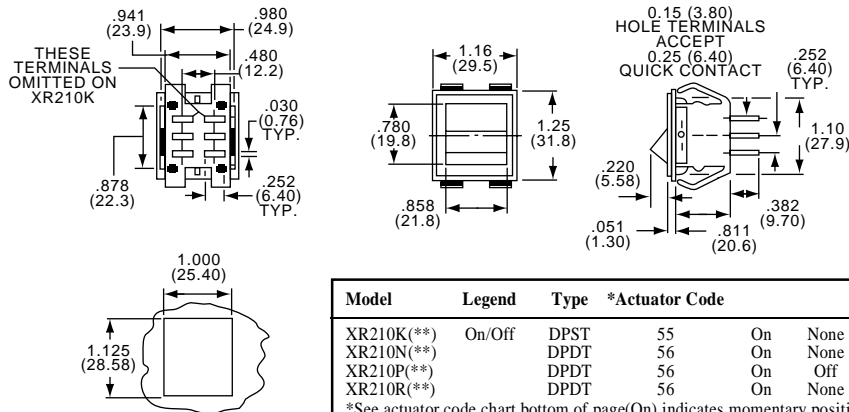

Model	Legend	Type	*Actuator Code	Color Codes
XR210K(**)	On/Off	DPST	55	On None Off 00, 02, 09, 90, 92
XR210N(**)		DPDT	56	On None On 00, 02, 09, 90, 92
XR210P(**)		DPDT	56	On Off On 00, 02, 09, 90, 92
XR210R(**)		DPDT	56	On None (On) 00, 02, 09, 90, 92

*See actuator code chart bottom of page (On) indicates momentary position.
 (**) Specify body and lever color by adding suffix number, see color ordering information top of page.
 †01 for international bar/circle imprint.

*ACTUATION CODES

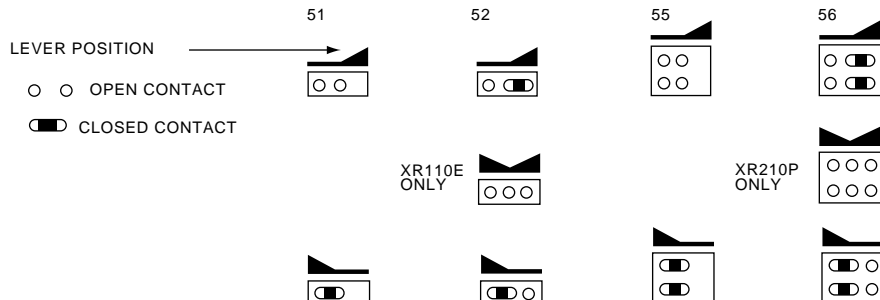

Thomas & Betts

Quality & Innovation From **AUGAT** Name Brand Products

E26

Thomas & Betts
 8155 T&B Blvd.
 Memphis, TN 38125
 (901) 252-5000 FAX (901) 252-1380

Illuminated Rocker "Pilot Light" 10 Amp XRL Series

FEATURES:

Illuminated XRL switches offer cost savings by including a Pilot light as an integral part of each switch. Standard models have neon lamp with ballast resistor for 105-125 VAC operation. Switch mechanism has same reliable design as other XR Series models, including wiping action contacts, snap-in mounting, dual-purpose

0.250" tab terminals and rugged molded cases and actuators. Internally patterned polycarbonate lenses provide attractive appearance. XRL110 models have semi-independent lamp circuit; XRL210 models have lamp circuit completely isolated from switch circuit. U.L. Listed (File No. E46765) and C.S.A. Certified (File No. LR75648).

MATERIAL SPECIFICATIONS:

Case Polyamide
 Actuator Acrylic
 Contacts Copper alloy
 Panel Accommodations030" to .250"
 Terminals Will accept .250" quick connect or solder

TYPICAL PERFORMANCE CHARACTERISTICS:

Contact Rating 10 A @ 125 VAC, 5 A @ 250 VAC
 Initial Contact Resistance 50 Milliohms max.
 Insulation Resistance 1,000 Megohms min.
 Operation Force 15 to 50 Ounces
 Life Expectancy Over 10,000 Cycles

Color Ordering Information

Complete the model Number by adding a color from the list of standard colors. XRL1 types require a 2-digit code; XRL2 types require a 3-digit code.

Color Code	Body	Rocker	Lens
02	Black	Red	
04	Black	Amber	
99	White	Clear	
004	Black	Black	Amber
024	Black	Red	Amber
094	Black	White	Amber
909	White	Black	Clear
929	White	Red	Clear
94	White	Amber	

EXAMPLE: XRL210A094
 Body color: black (0) | |
 Lever color: white (9) | |
 Lens color: amber (4)

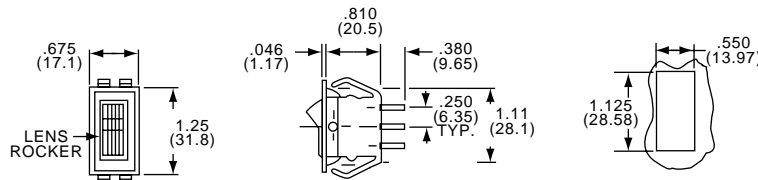

SPST



XRL110A02

Model	Type	*Actuator Code	Function	(**) Color Codes
XRL110A(**)	SPST	61	On None Off	02, 04, 94, 99

*See actuator code chart bottom of page.
 (**) Specify body and lever color by adding suffix number, see color ordering information top of page.

Accepts .250 (6.41) Quick Connect

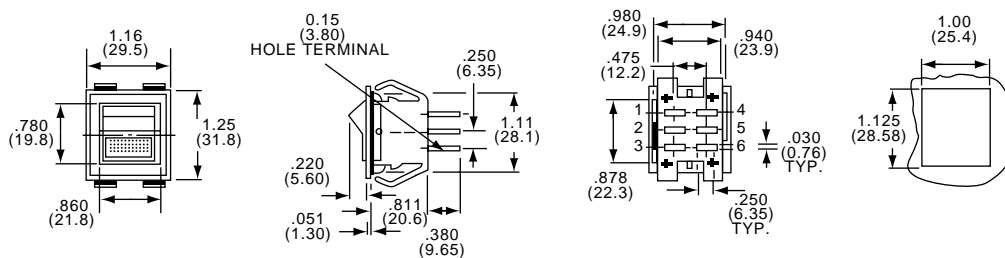

DPST



XRL210A094

Model	Type	*Actuator Code	Function	(***) Color Codes
XRL210A(***)	DPST	63	On None Off	004, 024, 094, 909, 929
XRL210D(***)	DPDT	64	On None On	004, 024, 094, 909, 929
XRL210F(***)	DPDT	64	On None (On)	004, 024, 094, 909, 929

*See actuator code chart bottom of page.
 (***) Specify body and lever color by adding suffix number, see color ordering information top of page.

Accepts .250 (6.41) Quick Connect

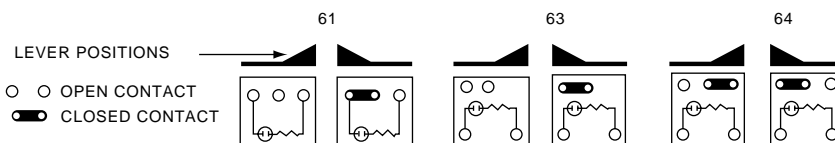

*ACTUATION CODES

Need more technical information?

Consult your Thomas & Betts sales office listed on the back cover

XR116 Series "16 Amp" Power Rockers Switch

TYPICAL PERFORMANCE CHARACTERISTICS:

Contact Rating 16 A @ 125 VAC (P.F. =0.75)
 10 A @ 250 VAC (P.F. =0.75)
 10 (4) @ 250 V~(V.D.E.)
 Initial Contact Resistance Under 100 milliohms.
 In-Rush Current 50 Amperes peak, max.
 Dielectric Strength 1,500 VRMS @ sea level
 Life Expectancy 50,000 Operations minimum

U.L. Listed (File No. E46765) and C.S.A. Certified
 (File No. LR75648).



XR116A09+ONOFF

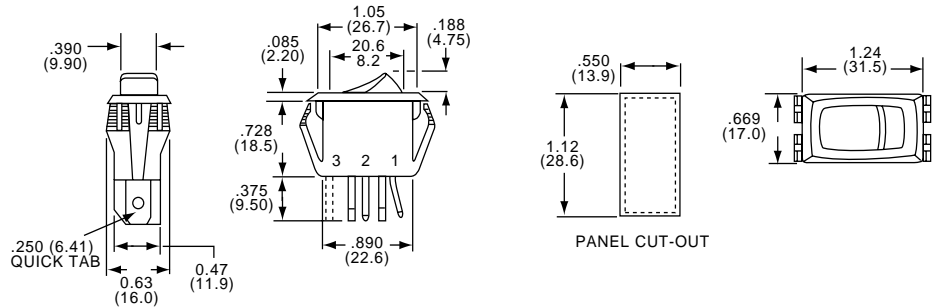

SPST 16A Rocker Switches					SPST 16A Lighted Rocker Switches				
Model	Rocker	Indicator Or Imprint	Legend	Beveled Frame	Model	Rocker	Indicator Or Imprint	Legend	Beveled Frame
XR116A002	Black	Red(1)	None	Black	XRL116A02	Red	120V Neon (4)	None	Black
XR116A00+On-Off	Black	White(2)	On-Off	Black	XRL116A04	Yellow	120V Neon (4)	None	Black
XR116A02+On-Off	Red	White(2)	On-Off	Black	XRL116A09	White	120V Neon (4)	None	Black
XR116A09+On-Off	White	Black(2)	On-Off	Black					
XR116A00+01	Black	White(2)	Bar/Circle	Black					
XR116A02+01	Red	White(2)	Bar/Circle	Black					
XR116A09+01	White	Black(2)	Bar/Circle	Black					
XR116A002+On-Off	Black	Red(3)	On-Off	Black					
XR116A002+01	Black	Red(3)	Bar/Circle	Black					
XR116A005+01	Black	Green(1)	Bar/Circle	Black					

(1) Double-shot molded indicator is visible when contacts are closed.
 (2) Imprinted legend is hot stamped on one-color rocker.
 (3) Legend, and indicator visible when contacts are closed, are double-shot molded.
 (4) Series resistor built in. Lamp circuit is between terminals 2&3.

XRM Series "10 Amp" Mini Power Rocker Switch

TYPICAL PERFORMANCE CHARACTERISTICS:

Contact Rating 10 A @ 125 VAC (resistive)
 8 A @ 125 VAC (P.F. +=0.75)
 4 A @ 250 VAC
 6 (4) A @ 250 V~(V.D.E.)
 Initial Contact Resistance Under 30 Milliohms
 Dielectric Strength 1,500 VRMS @ sea level

Model	Type	(*) Specify Color Codes		
XRM110D(*)	SPDT On On	00, 09, 90		
XRM110D(*)+01†	SPDT On On	00, 02, 09, 90		
XRM110F(*)	SPDT On (On)	00, 09, 90		
XRM210N(*)	DPDT On On	00, 09, 90		
XRM210N(*)+01†	DPDT On On	00, 02, 09, 90		
XRM210R(*)	DPDT On (On)	00, 09, 90		

(On) indicates momentary position. (*) Specify 2-digit color-code: body, then rocker.
 (†) +01 indicates bar/circle imprint. 0 = Black; 2 = Red; 9 = White.

U.L. Listed (File No. E46765) and C.S.A. Certified (File No. LR75648).

SPDT/DPDT



XRM210N09

XRM110D00

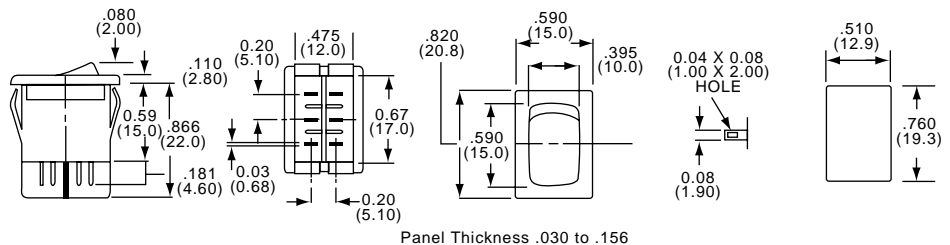

Thomas & Betts

Quality & Innovation From **AUGAT** Name Brand Products

E28

Thomas & Betts
 8155 T&B Blvd.
 Memphis, TN 38125
 (901) 252-5000 FAX (901) 252-1380

"8 Amp" Mini Power Rocker Switch Euro-Rockers

FEATURES:

XRMQ Series miniature rocker switches have the same reliable characteristics as the XRM series, but have 0.187" tab terminals. U.L., C.S.A. & VDE certifications. U.L. Listed (File No. E46765) and C.S.A. Certified (File No. LR75648).

TYPICAL PERFORMANCE CHARACTERISTICS:

Contact Rating 8 A @ 125 VAC (P.F. =0.75)
 4 A @ 250 VAC (P.F. =0.75)
 Inductive 6 (4) A @ 250 V~(V.D.E.)
 Initial Contact Resistance 50 Milliohms max.
 Insulation Resistance 100 Megohms
 Dielectric Strength 1,000 RMS @ sea level
 In-Rush Current 35 Peak amperes max.

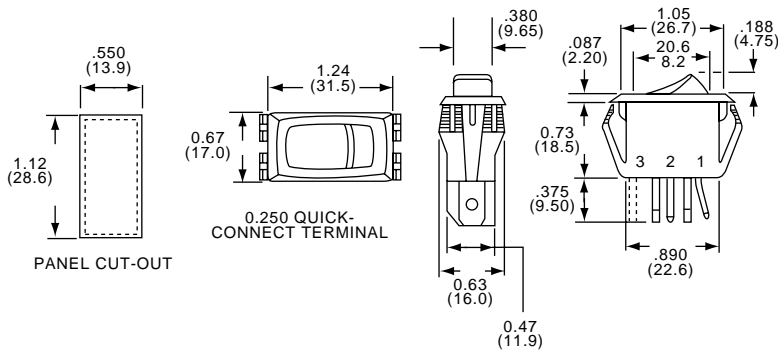

XRMQ208K005+01

Euro-Rocker switches have the preferred green ISO bar-circle legend and are V.D.E. certified in addition to UL and CSA.

Model-Legend	Type	(Body/Rocker)	(Legend)	Tab Terminal
XRMQ108A005+01	SPST	Black/Black	Green	0.187
XRMQ208K005+01	DPST	Black/Black	Green	0.187

Application Note:
 See Page E26 for Actuator Codes
 SPST Code 51 DPST Code 55

"8 Amps" Mini Power Rocker Switch XRMQ Series

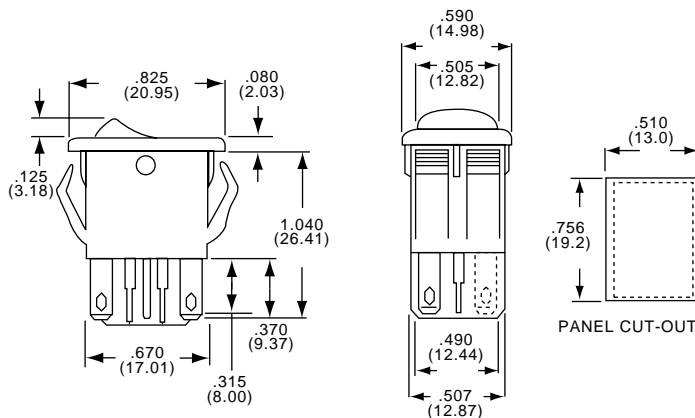

XRMQ108A02

Model-Legend	Type	Body/Rocker	Legend	Model-Legend	Type	Body/Rocker	Legend
XRMQ108A00	SPST	Black/Black	None	XRMQ208K00	DPST	Black/Black	None
XRMQ108A00+01	SPST	Black/Black	White ISO	XRMQ208K00+01	DPST	Black/Black	White ISO
XRMQ108A02	SPST	Black/Red	None	XRMQ208K02	DPST	Black/Red	None
XRMQ108A02+01	SPST	Black/Red	White ISO	XRMQ208K02+01	DPST	Black/Red	White ISO
				XRMQ208K02OnOff	DPST	Black/Red	On/Off
				XRMQ208N00+01	DPDT	Black/Black	White ISO
				XRMQ208N00	DPDT	Black/Black	

Application Note:
 See Page E26 for Actuator Codes
 SPST Code 51 DPST & DPDT
 Code 55

Need more technical information?

Consult your Thomas & Betts
 sales office listed on the back cover