

A5KP-G Series

Breakdown Voltage: 6.8 to 440 Volts

Peak Pulse Power: 5000 Watts

RoHS Device

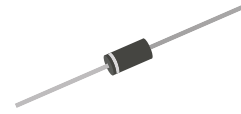

Features

- Glass passivated chip.
- 5000W peak pulse power capability with a 10/1000 μ s waveform, repetitive rate (duty cycle):0.01%
- Low leakage.
- Uni and Bidirectional unit.
- Excellent clamping capability.
- Very fast response time.
- Comply with AEC-Q101
- UL recognized file # E349157  Range: A5KP5.0(C)A thru. A5KP190(C)A

Mechanical Data

- Case: Molded plastic.
- Epoxy: UL 94V-0 rate flame retardant
- Lead: Solderable per MIL-STD-202, method 208 guaranteed.
- Polarity: Color band denotes cathode end except Bipolar.
- Mounting position: Any

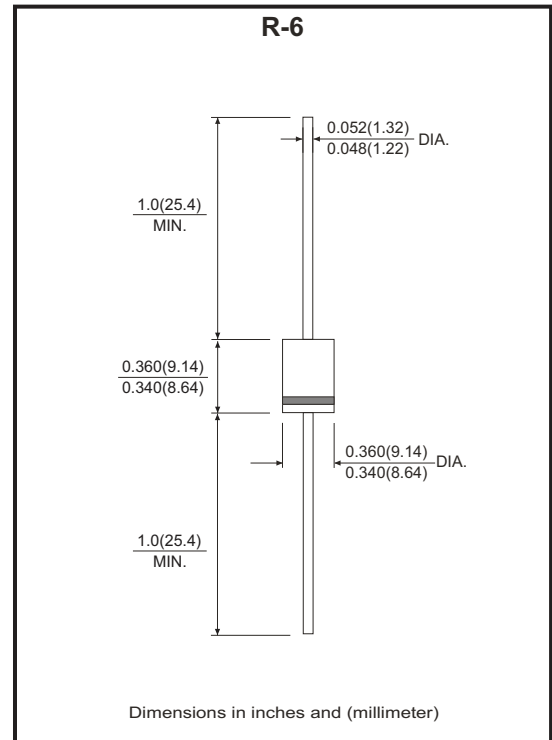

Maximum Ratings and Electrical Characteristics

Rating at 25°C ambient temperature unless otherwise specified.
Single phase, half wave, 60Hz, resistive or inductive loaded.
For capacitive load, derated current by 20%.

Parameter	Symbol	Value	Unit
Peak power dissipation with a 10/1000 μ s waveform (Note 1)	P _{PP}	5000	W
Peak pulse current with a 10/1000 μ s waveform (Note 1)	I _{PP}	See Next Table	A
Power dissipation on infinite heatsink at T _L =75°C	P _D	8.0	W
Peak forward surge current, 8.3ms single half sine-wave unidirectional only (Note 2)	I _{FSM}	500	A
Maximum instantaneous forward voltage at 100A for uni-directional devices only (Note 3)	V _F	3.5 / 5.0	V
Operating junction and storage temperature range	T _J , T _{STG}	-55 to +150	°C

NTOES:

- (1) Non-repetitive current pulse, per fig.5 and derated above TA=25°C per fig.1
- (2) Measured on 8.3 ms single half sine wave of equivalent square wave, duty cycle=4 pulses per minute maximum.
- (3) V_F<3.5V for devices of V_{BR}<200V and V_F<5.0V for devices of V_{BR}>201V

Company reserves the right to improve product design , functions and reliability without notice.

REV:B

RATING AND CHARACTERISTIC (A5KP-G Series)

Fig.1 - Pulse Derating Curve

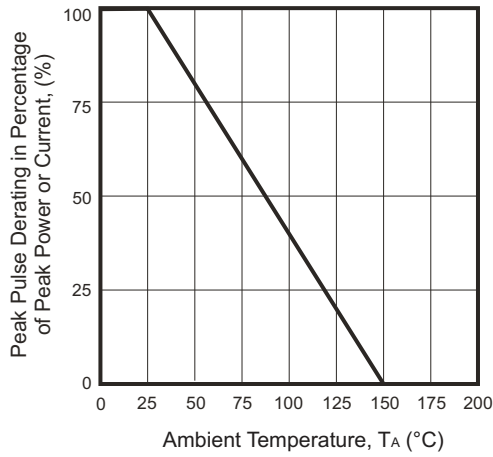

Fig.2 - Maximum Non-Repetitive Surge Current

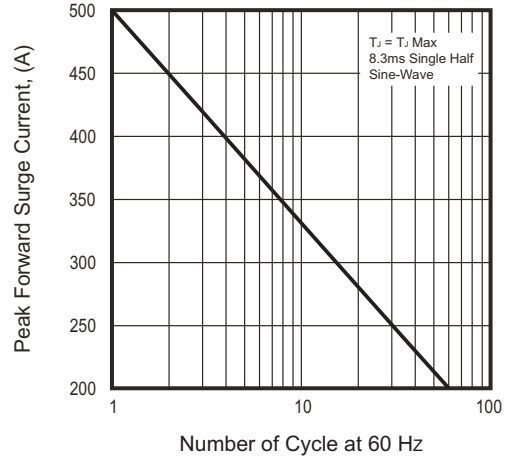

Fig.3 - Steady State Power Derating Curve

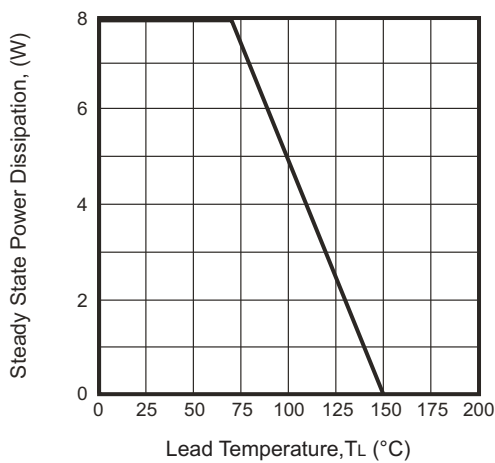

Fig.4 - Peak Pulse Power Rating Curve

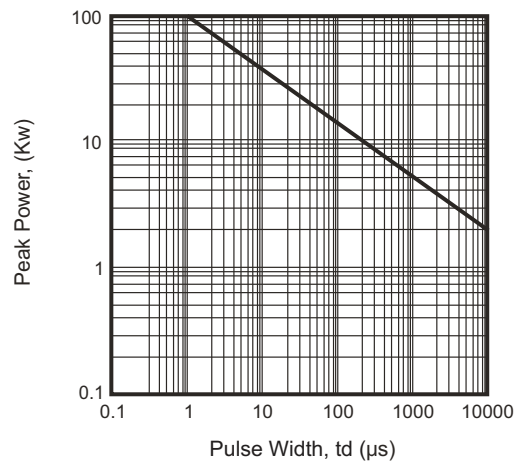

Fig.5 - Pulse Waveform

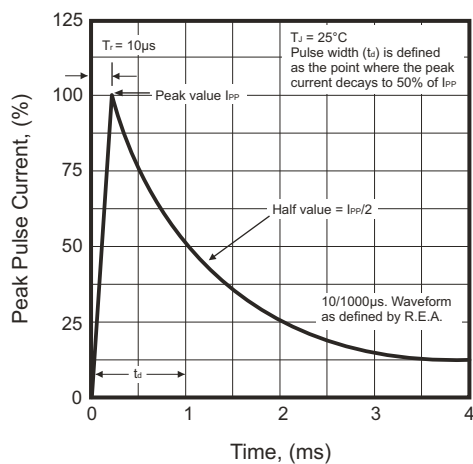
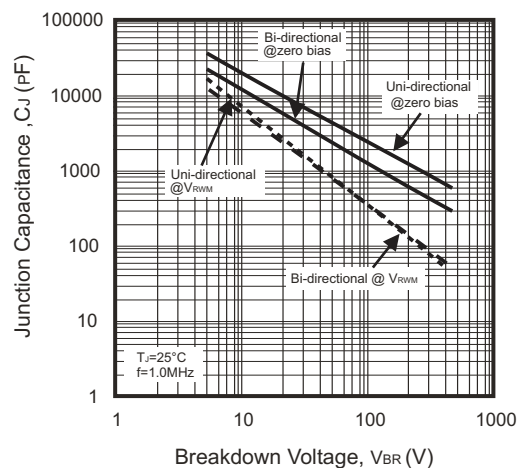

Fig.6 - Typical Junction Capacitance



Company reserves the right to improve product design, functions and reliability without notice.

REV:B

5000W Transient Voltage Suppressor



Electrical Characteristics (A5KP-G Series)

Part No.	Breakdown voltage VBR @ IT			Maximum Reverse Leakage @VRWM IR (uA)	Working Peak Reverse Voltage VRWM (V)	Maximum Reverse Surge Current IPP (A)	Maximum Clamping Voltage @IPP Vc (V)	Marking Code	
	Min. (V)	Max. (V)	IT (mA)					UNI	BI
A5KP5.0(C)A-G	6.40	7.00	50	5000	5.0	543.48	9.2	5KP5.0A	5KP5.0CA
A5KP6.0(C)A-G	6.67	7.37	50	5000	6.0	485.44	10.3	5KP6.0A	5KP6.0CA
A5KP6.5(C)A-G	7.22	7.98	50	2000	7.0	446.43	11.2	5KP6.5A	5KP6.5CA
A5KP7.0(C)A-G	7.78	8.60	50	1000	7.0	416.67	12.0	5KP7.0A	5KP7.0CA
A5KP7.5(C)A-G	8.33	9.21	5	250	8.0	387.60	12.9	5KP7.5A	5KP7.5CA
A5KP8.0(C)A-G	8.89	9.83	5	150	8.0	367.65	13.6	5KP8.0A	5KP8.0CA
A5KP8.5(C)A-G	9.44	10.40	5	50	9.0	347.22	14.4	5KP8.5A	5KP8.5CA
A5KP9.0(C)A-G	10.00	11.10	5	20	9.0	324.68	15.4	5KP9.0A	5KP9.0CA
A5KP10(C)A-G	11.10	12.30	5	15	10.0	294.12	17.0	5KP10A	5KP10CA
A5KP11(C)A-G	12.20	13.50	5	2	11.0	274.73	18.2	5KP11A	5KP11CA
A5KP12(C)A-G	13.30	14.70	5	2	12.0	251.26	19.9	5KP12A	5KP12CA
A5KP13(C)A-G	14.40	15.90	5	2	13.0	232.56	21.5	5KP13A	5KP13CA
A5KP14(C)A-G	15.60	17.20	5	2	14.0	215.52	23.2	5KP14A	5KP14CA
A5KP15(C)A-G	16.70	18.50	5	2	15.0	204.92	24.4	5KP15A	5KP15CA
A5KP16(C)A-G	17.80	19.70	5	2	16.0	192.31	26.0	5KP16A	5KP16CA
A5KP17(C)A-G	18.90	20.90	5	2	17.0	181.16	27.6	5KP17A	5KP17CA
A5KP18(C)A-G	20.00	22.10	5	2	18.0	171.23	29.2	5KP18A	5KP18CA
A5KP19(C)A-G	21.10	23.30	5	2	19.0	162.44	30.8	5KP19A	5KP19CA
A5KP20(C)A-G	22.20	24.50	5	2	20.0	154.32	32.4	5KP20A	5KP20CA
A5KP22(C)A-G	24.40	26.90	5	2	22.0	140.85	35.5	5KP22A	5KP22CA
A5KP24(C)A-G	26.70	29.50	5	2	24.0	128.53	38.9	5KP24A	5KP24CA
A5KP26(C)A-G	28.90	31.90	5	2	26.0	118.76	42.1	5KP26A	5KP26CA
A5KP28(C)A-G	31.10	34.40	5	2	28.0	110.13	45.4	5KP28A	5KP28CA
A5KP30(C)A-G	33.30	36.80	5	2	30.0	103.31	48.4	5KP30A	5KP30CA
A5KP33(C)A-G	36.70	40.60	5	2	33.0	93.81	53.3	5KP33A	5KP33CA
A5KP36(C)A-G	40.00	44.20	5	2	36.0	86.06	58.1	5KP36A	5KP36CA
A5KP40(C)A-G	44.40	49.10	5	2	40.0	77.52	64.5	5KP40A	5KP40CA
A5KP43(C)A-G	47.80	52.80	5	2	43.0	72.05	69.4	5KP43A	5KP43CA
A5KP45(C)A-G	50.00	55.30	5	2	45.0	68.78	72.7	5KP45A	5KP45CA
A5KP48(C)A-G	53.30	58.90	5	2	48.0	64.60	77.4	5KP48A	5KP48CA
A5KP51(C)A-G	56.70	62.70	5	2	51.0	60.68	82.4	5KP51A	5KP51CA
A5KP54(C)A-G	60.00	66.30	5	2	54.0	57.41	87.1	5KP54A	5KP54CA
A5KP58(C)A-G	64.40	71.20	5	2	58.0	53.42	93.6	5KP58A	5KP58CA
A5KP60(C)A-G	66.70	73.70	5	2	60.0	51.65	96.8	5KP60A	5KP60CA
A5KP64(C)A-G	71.10	78.60	5	2	64.0	48.54	103.0	5KP64A	5KP64CA
A5KP70(C)A-G	77.80	86.00	5	2	70.0	44.25	113.0	5KP70A	5KP70CA
A5KP75(C)A-G	83.30	92.10	5	2	75.0	41.32	121.0	5KP75A	5KP75CA
A5KP78(C)A-G	86.70	95.80	5	2	78.0	39.68	126.0	5KP78A	5KP78CA
A5KP80(C)A-G	88.80	97.60	5	2	80.0	38.58	129.6	5KP80A	5KP80CA
A5KP85(C)A-G	94.40	104.00	5	2	85.0	36.50	137.0	5KP85A	5KP85CA

- Note: 1) Suffix A denotes 5% tolerance devices.
 2) Add suffix "C" or "CA" after part number to specify Bi-directional devices.
 3) For Bi-Directional devices having VR of 10 volts and under, the IR limit is double.

Company reserves the right to improve product design , functions and reliability without notice.

5000W Transient Voltage Suppressor

Electrical Characteristics (A5KP-G Series)

Part No.	Breakdown voltage V _{BR} @ I _T			Maximum Reverse Leakage @V _{RWM} I _R (uA)	Working Peak Reverse Voltage V _{RWM} (V)	Maximum Reverse Surge Current I _{PP} (A)	Maximum Clamping Voltage @I _{PP} V _c (V)	Marking Code	
	Min. (V)	Max. (V)	I _T (mA)					UNI	BI
A5KP90(C)A-G	100.00	111.00	5	2	90.0	34.25	146.0	5KP90A	5KP90CA
A5KP100(C)A-G	111.00	123.00	5	2	100.0	30.86	162.0	5KP100A	5KP100CA
A5KP110(C)A-G	122.00	135.00	5	2	110.0	28.25	177.0	5KP110A	5KP110CA
A5KP120(C)A-G	133.00	147.00	5	2	120.0	25.91	193.0	5KP120A	5KP120CA
A5KP130(C)A-G	144.00	159.00	5	2	130.0	23.92	209.0	5KP130A	5KP130CA
A5KP140(C)A-G	155.00	171.00	5	2	140.0	22.05	226.8	5KP140A	5KP140CA
A5KP150(C)A-G	167.00	185.00	5	2	150.0	20.58	243.0	5KP150A	5KP150CA
A5KP160(C)A-G	178.00	197.00	5	2	160.0	19.31	259.0	5KP160A	5KP160CA
A5KP170(C)A-G	189.00	209.00	5	2	170.0	18.18	275.0	5KP170A	5KP170CA
A5KP180(C)A-G	200.00	220.00	5	2	180.0	17.15	291.6	5KP180A	5KP180CA
A5KP190(C)A-G	211.00	232.00	5	2	190.0	16.24	307.8	5KP190A	5KP190CA
A5KP200(C)A-G	224.00	247.00	5	2	200.0	15.43	324.0	5KP200A	5KP200CA
A5KP210(C)A-G	233.00	258.00	5	2	210.0	14.31	349.5	5KP210A	5KP210CA
A5KP220(C)A-G	246.00	272.00	5	2	220.0	14.04	356.0	5KP220A	5KP220CA
A5KP250(C)A-G	279.00	309.00	5	2	250.0	12.35	405.0	5KP250A	5KP250CA
A5KP300(C)A-G	335.00	371.00	5	2	300.0	10.29	486.0	5KP300A	5KP300CA
A5KP350(C)A-G	391.00	432.00	5	2	350.0	8.82	567.0	5KP350A	5KP350CA
A5KP400(C)A-G	447.00	494.00	5	2	400.0	7.72	648.0	5KP400A	5KP400CA
A5KP440(C)A-G	492.00	543.00	5	2	440.0	7.01	713.0	5KP440A	5KP440CA

Note: 1) Suffix A denotes 5% tolerance devices.
 2) Add suffix "C" or "CA" after part number to specify Bi-directional devices.
 3) For Bi-Directional devices having V_R of 10 volts and under, the I_R limit is double.

Taping Specification For Axial Lead Diodes

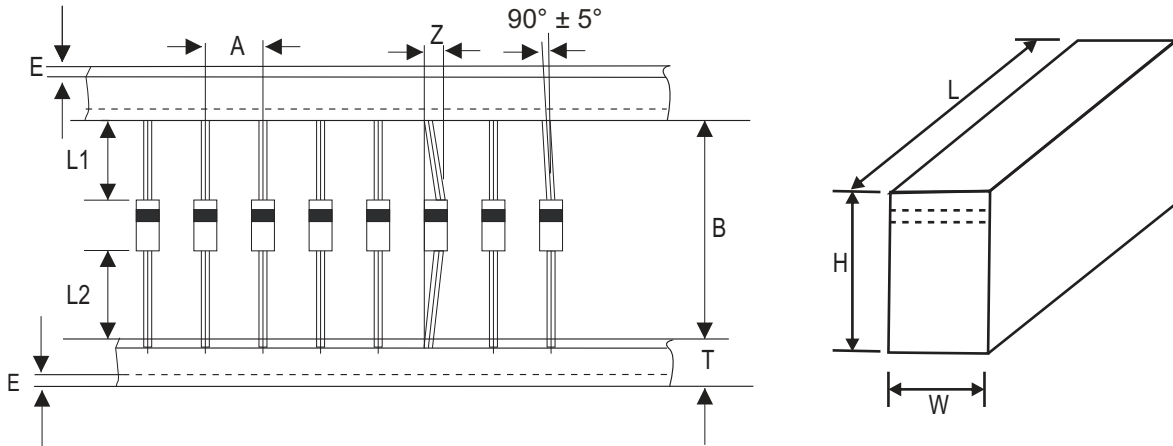

R-6	SYMBOL	A	B	Z	T	E
	(mm)	10.00 ± 0.50	52.00 ± 0.50	1.20 (max)	6.00 ± 0.40	1.00 (max)
	(inch)	0.394 ± 0.020	2.047 ± 0.020	0.047 (max)	0.236 ± 0.016	0.039 (max)

R-6	SYMBOL	L1	L2	L	W	H
	(mm)	1.00 (max)	1.00 (max)	260.00	75.00	145.00
	(inch)	0.039 (max)	0.039 (max)	10.236	2.953	5.709

Standard Packaging

Case Type	AMMO PACK	
	BOX (pcs)	CARTON (pcs)
R-6	250	3,750