

REVISIONS					
REV	ECO	DESCRIPTION	DATE	BY	APPR
A1	-	RELEASE NEW DRAWING	11APR18	ROOKIE	TOMMY
A2	-	REVISED DESCRIPTION	12JUN19	JAH	DH
A3	-	UPDATE THE APPEARANCE	11NOV21	RONALD	TOMMY

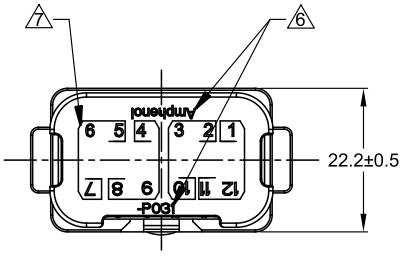
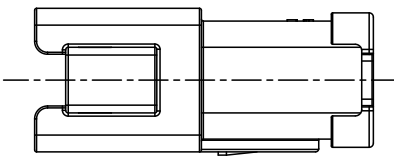
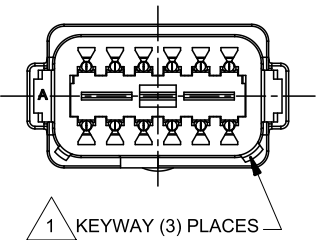
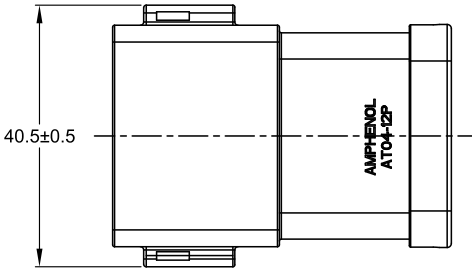

NOTES: UNLESS OTHERWISE SPECIFIED

△ SEE SHEET 2 FOR KEY ARRANGEMENTS AND COLORS.

2. MATERIAL:  
HOUSING: THERMOPLASTIC  
SEAL: SILICONE RUBBER  
CONTACT: COPPER ALLOY

3. MODIFICATIONS: 4 PIECES OF 3 PIN BUSBAR WITH GOLD PLATED

4. SPECIFICATIONS:  
4.1 CURRENT RATING: 13 AMPS MAXIMUM FOR THE 3 PIN BUSBAR  
4.2 OPERATING TEMPERATURE: -55°C TO +125°C.  
4.3 DIELECTRIC WITHSTANDING VOLTAGE: LESS THAN 2 MILLIAMPS CURRENT LEAKAGE @ 1500 VOLTS AC.  
4.4 INSULATION RESISTANCE: 1000 MEGOHM MIN @ 25°C.  
4.5 MOISTURE RESISTANCE: IP69K & IP68 (1M OF WATER FOR A PERIOD OF 24 HOURS, MATED CONDITION)  
4.6 MATING CYCLE DURABILITY: 100 CYCLES  
4.7 RoHS COMPLIANT

5. MATING PART: AT06-12SX\* PLUG  
(X=A,B,C,D KEYS \* = AVAILABLE MODIFICATIONS )

△ ORIENTATION OF "Amphenol" AND "-P031" TO BE OPTIONAL

△ BORDERS SIGNIFY THAT EACH GROUP OF PINS (PINS 1,11,12 , PINS 2,3,10, PINS 4,8,9 AND PINS 5,6,7) ARE BUSSED TOGETHER WITH A 3 PIN BUSBAR

8. ALL DIMENSIONS ARE FOR REFERENCE USE ONLY.

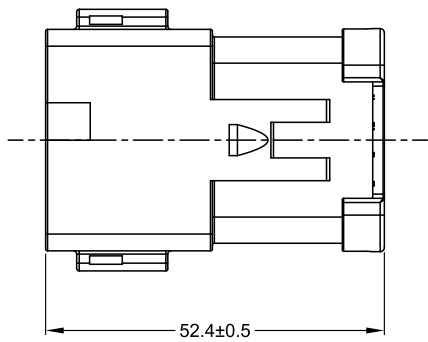

1 REFER TO SHEET 2 FOR AVAILABLE CONNECTOR COLORS

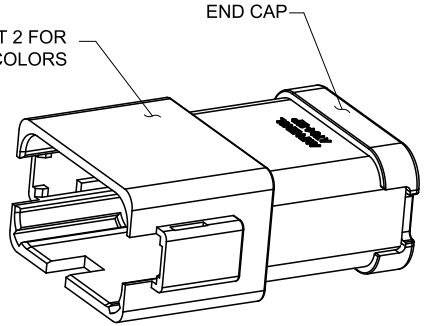

SEE SHEET 2		REF: DT04-12PA-P031 & DT04-12PB-P031 & DT04-12PC-P031 & DT04-12PD-P031	
PART NUMBER		DESCRIPTION	
QUANTITY	MATERIALS LIST		
UNLESS OTHERWISE SPECIFIED 1) All dimensions are in metric(mm). 2) Tolerances are as follows: 1 PL DEC ±0.30   Fractions ±1/64 2 PL DEC ±0.15   Angles ±1° 3 PL DEC ±0.08 3) Note reference = △		SIGNATURES DATE DRAWN: RONALD 11NOV21 CHECKED: ORION 12NOV21 ENGINEER: APPROVAL: TOMMY 15NOV21	
MATERIAL SPECIFICATIONS: <b>WEIGHT: 27.4g</b>		CUSTOMER: THIS DRAWING IS SUPPLIED FOR INFORMATION ONLY. DESIGN FEATURES, SPECIFICATIONS AND PERFORMANCE DATA SHOWN HEREON ARE THE PROPERTY OF THE AMPHENOL CORPORATION. NO RIGHTS OF REPRODUCTION ARE IMPLIED. ALL DIMENSIONS ARE SUBJECT TO NORMAL MANUFACTURING VARIATIONS.	
PROCESS SPECIFICATIONS:		SIZE TYPE DWG NO. REVISION <b>B C- AT04-12PX-P031 A3</b>	
NEXT ASSY:		SCALE: NONE SHEET 1 OF 2	

TITLE: HYPERBUSS AT 12WAY RECP (4)3 PIN BUSBAR GOLD-PLATED DWG NO: AT04-12PX-P031 REV: A3 SH: 1 OF: 2

REVISIONS					
REV	ECO	DESCRIPTION	DATE	BY	APPR
A1	-	RELEASE NEW DRAWING	11APR18	ROOKIE	TOMMY
A2	-	REVISED DESCRIPTION	12JUN19	JAH	DH
A3	-	UPDATE THE APPEARANCE	11NOV21	RONALD	TOMMY

P/N AT04-12PA-P031  
KEY-A CONFIGURATION  
STANDARD COLOR: GREY

P/N AT04-12PB-P031  
KEY-B CONFIGURATION  
STANDARD COLOR: BLACK

P/N AT04-12PC-P031  
KEY-C CONFIGURATION  
STANDARD COLOR: GREEN

P/N AT04-12PD-P031  
KEY-D CONFIGURATION  
STANDARD COLOR: BROWN

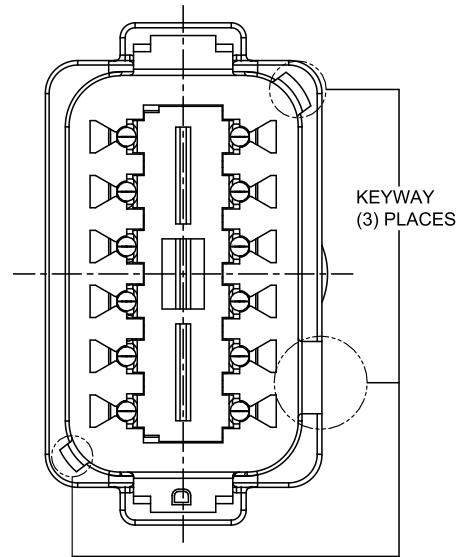
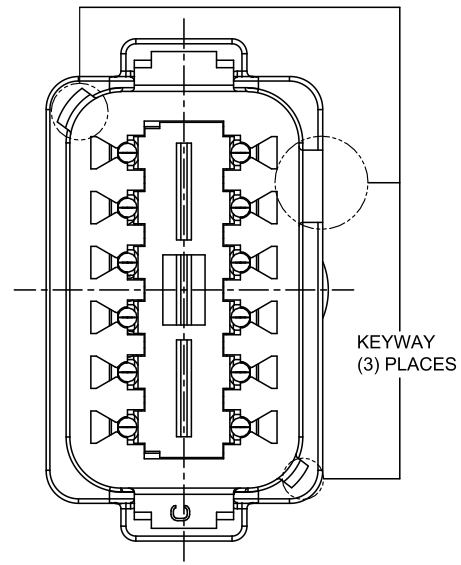
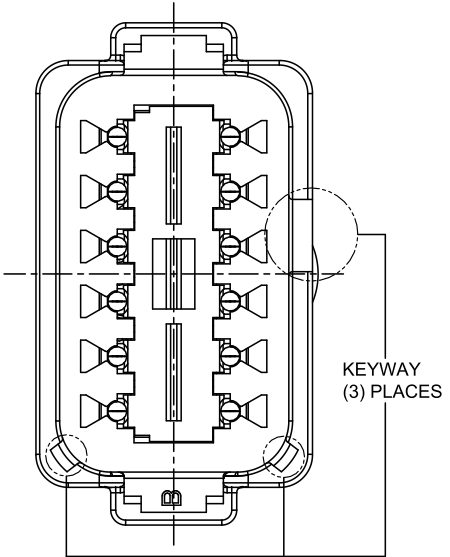
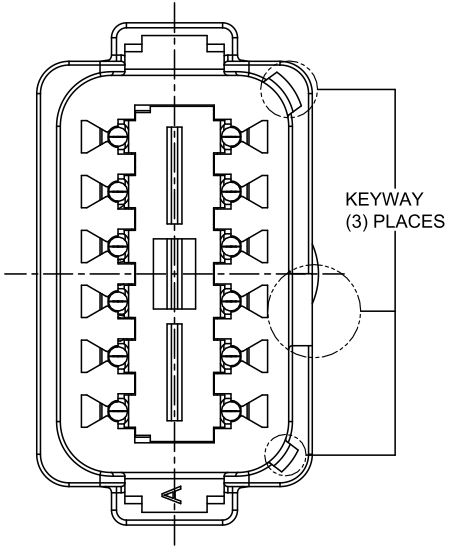

TITLE: HYPERBUSS AT 12WAY RECP (4)3 PIN BUSBAR GOLD-PLATED  
DWG NO: AT04-12PX-P031  
REV: A3  
SH: 2  
OF: 2

QUANTITY	PART NUMBER	DESCRIPTION	ITEM
<b>MATERIALS LIST</b>			
<small>UNLESS OTHERWISE SPECIFIED</small> 1) All dimensions are in metric(mm). 2) Tolerances are as follows: 1 PL DEC ±0.30   Fractions ±1/64 2 PL DEC ±0.15   Angles ±1° 3 PL DEC ±0.08 3) Note reference =		<b>Amphenol</b> Sine Systems - www.amphenol-sine.com 44724 Morley Drive Clinton Township, MI 48036	
MATERIAL SPECIFICATIONS: <b>WEIGHT:27.4g</b>		CUSTOMER: THIS DRAWING IS SUPPLIED FOR INFORMATION ONLY. DESIGN FEATURES, SPECIFICATIONS AND PERFORMANCE DATA SHOWN HEREON ARE THE PROPERTY OF THE AMPHENOL CORPORATION. NO RIGHTS OF REPRODUCTION ARE IMPLIED. ALL DIMENSIONS ARE SUBJECT TO NORMAL MANUFACTURING VARIATIONS.	
PROCESS SPECIFICATIONS: NEXT ASSY:		SIGNATURES      DATE DRAWN: RONALD      11NOV21 CHECKED: ORION      12NOV21 APPROVAL: TOMMY      15NOV21 SIZE: <b>B C-</b> DWG NO: <b>AT04-12PX-P031</b> REVISION: <b>A3</b> SCALE: <b>NONE</b> SHEET <b>2</b> OF <b>2</b>	