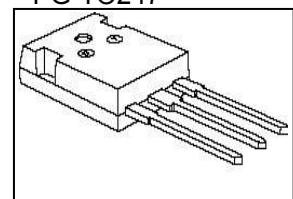

**CoolMOS™ Power Transistor**
**Features**

- New revolutionary high voltage technology
- Ultra low gate charge
- Periodic avalanche rated
- Extreme  $dv/dt$  rated
- Ultra low effective capacitances
- Improved transconductance
- Pb-free lead plating; RoHS compliant
- Qualified according to JEDEC<sup>0)</sup> for target applications

**Product Summary**

$V_{DS} @ T_{j,max}$	650	V
$R_{DS(on),max}$	0.1	$\Omega$
$I_D$	34.6	A

**PG-TO247**

Type	Package	Ordering Code	Marking
SPW35N60C3	PG-TO247	Q67040-S4673	35N60C3

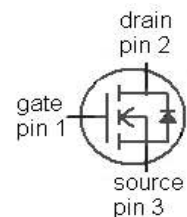
**Maximum ratings, at  $T_j=25\text{ }^\circ\text{C}$ , unless otherwise specified**

Parameter	Symbol	Conditions	Value	Unit
Continuous drain current	$I_D$	$T_C=25\text{ }^\circ\text{C}$	34.6	A
		$T_C=100\text{ }^\circ\text{C}$	21.9	
Pulsed drain current <sup>1)</sup>	$I_{D,pulse}$	$T_C=25\text{ }^\circ\text{C}$	103.8	
Avalanche energy, single pulse	$E_{AS}$	$I_D=17.3\text{ A}$ , $V_{DD}=50\text{ V}$	1500	mJ
Avalanche energy, repetitive $t_{AR}$ <sup>1),2)</sup>	$E_{AR}$	$I_D=34.6\text{ A}$ , $V_{DD}=50\text{ V}$	1.5	
Avalanche current, repetitive $t_{AR}$ <sup>1)</sup>	$I_{AR}$		34.6	A
Drain source voltage slope	$dv/dt$	$I_D=34.6\text{ A}$ , $V_{DS}=480\text{ V}$ , $T_j=125\text{ }^\circ\text{C}$	50	V/ns
Gate source voltage	$V_{GS}$	static	$\pm 20$	V
	$V_{GS}$	AC ( $f > 1\text{ Hz}$ )	$\pm 30$	
Power dissipation	$P_{tot}$	$T_C=25\text{ }^\circ\text{C}$	313	W
Operating and storage temperature	$T_j$ , $T_{stg}$		-55 ... 150	$^\circ\text{C}$
Reverse diode $dv/dt$ <sup>6)</sup>	$dv/dt$		15	V/ns

Parameter	Symbol	Conditions	Values			Unit
			min.	typ.	max.	
<b>Thermal characteristics</b>						
Thermal resistance, junction - case	$R_{thJC}$		-	-	0.4	K/W
Thermal resistance, junction - ambient	$R_{thJA}$	leaded	-	-	62	
Soldering temperature, wavesoldering	$T_{sold}$	1.6 mm (0.063 in.) from case for 10 s	-	-	260	°C

**Electrical characteristics, at  $T_j=25\text{ °C}$ , unless otherwise specified**

**Static characteristics**

Drain-source breakdown voltage	$V_{(BR)DSS}$	$V_{GS}=0\text{ V}, I_D=250\text{ }\mu\text{A}$	600	-	-	V
Avalanche breakdown voltage	$V_{(BR)DS}$	$V_{GS}=0\text{ V}, I_D=34.6\text{ A}$	-	700	-	
Gate threshold voltage	$V_{GS(th)}$	$V_{DS}=V_{GS}, I_D=1.9\text{ mA}$	2.1	3	3.9	
Zero gate voltage drain current	$I_{DSS}$	$V_{DS}=600\text{ V}, V_{GS}=0\text{ V}, T_j=25\text{ °C}$	-	0.1	1	$\mu\text{A}$
		$V_{DS}=600\text{ V}, V_{GS}=0\text{ V}, T_j=150\text{ °C}$	-	-	100	
Gate-source leakage current	$I_{GSS}$	$V_{GS}=20\text{ V}, V_{DS}=0\text{ V}$	-	-	100	nA
Drain-source on-state resistance	$R_{DS(on)}$	$V_{GS}=10\text{ V}, I_D=21.9\text{ A}, T_j=25\text{ °C}$	-	0.081	0.1	$\Omega$
		$V_{GS}=10\text{ V}, I_D=21.9\text{ A}, T_j=150\text{ °C}$	-	0.2	-	
Gate resistance	$R_G$	$f=1\text{ MHz}$ , open drain	-	0.6	-	
Transconductance	$g_{fs}$	$ V_{DS} >2 I_D R_{DS(on)max}, I_D=21.9\text{ A}$	-	36	-	S

Parameter	Symbol	Conditions	Values			Unit
			min.	typ.	max.	

**Dynamic characteristics**

Input capacitance	$C_{iss}$	$V_{GS}=0\text{ V}, V_{DS}=25\text{ V}, f=1\text{ MHz}$	-	4500	-	pF
Output capacitance	$C_{oss}$		-	1500	-	
Reverse transfer capacitance	$C_{rss}$		-	100	-	
Effective output capacitance, energy related <sup>3)</sup>	$C_{o(er)}$	$V_{GS}=0\text{ V}, V_{DS}=0\text{ V}$ to 480 V	-	180	-	
Effective output capacitance, time related <sup>4)</sup>	$C_{o(tr)}$		-	324	-	
Turn-on delay time	$t_{d(on)}$	$V_{DD}=480\text{ V}, V_{GS}=10\text{ V}, I_D=34.6\text{ A}, R_G=3.3\ \Omega$	-	10	-	ns
Rise time	$t_r$		-	5	-	
Turn-off delay time	$t_{d(off)}$		-	70	-	
Fall time	$t_f$		-	10	-	

**Gate Charge Characteristics**

Gate to source charge	$Q_{gs}$	$V_{DD}=480\text{ V}, I_D=34.6\text{ A}, V_{GS}=0\text{ to }10\text{ V}$	-	18	-	nC
Gate to drain charge	$Q_{gd}$		-	70	-	
Gate charge total	$Q_g$		-	150	200	
Gate plateau voltage	$V_{plateau}$		-	5.3	-	V

<sup>1)</sup> Pulse width limited by maximum temperature  $T_{j,max}$  only

<sup>2)</sup> Repetitive avalanche causes additional power losses that can be calculated as  $P_{AV}=E_{AR} \cdot f$ .

<sup>3)</sup>  $C_{o(er)}$  is a fixed capacitance that gives the same stored energy as  $C_{oss}$  while  $V_{DS}$  is rising from 0 to 80%  $V_{DSS}$ .

<sup>4)</sup>  $C_{o(tr)}$  is a fixed capacitance that gives the same charging time as  $C_{oss}$  while  $V_{DS}$  is rising from 0 to 80%  $V_{DSS}$ .

<sup>6)</sup>  $I_{SD} \leq I_D, di/dt \leq 200\text{ A/us}, V_{DClink}=400\text{ V}, V_{peak} < V_{BR, DSS}, T_J < T_{J,max}$ .  
Identical low-side and high-side switch.

<sup>0)</sup> J-STD20 and JESD22

Parameter	Symbol	Conditions	Values			Unit
			min.	typ.	max.	

**Reverse Diode**

Diode continuous forward current	$I_S$	$T_C=25\text{ }^\circ\text{C}$	-	-	34.6	A
Diode pulse current	$I_{S,pulse}$		-	-	103.8	
Diode forward voltage	$V_{SD}$	$V_{GS}=0\text{ V}, I_F=34.6\text{ A}, T_j=25\text{ }^\circ\text{C}$	-	0.95	1.2	V
Reverse recovery time	$t_{rr}$	$V_R=480\text{ V}, I_F=I_S, di_F/dt=100\text{ A}/\mu\text{s}$	-	600	-	ns
Reverse recovery charge	$Q_{rr}$		-	21	-	$\mu\text{C}$
Peak reverse recovery current	$I_{rrm}$		-	90	-	A

**Typical Transient Thermal Characteristics**

Symbol	Value	Unit	Symbol	Value	Unit
	typ.			typ.	
$R_{th1}$	0.00441	K/W	$C_{th1}$	0.00037	Ws/K
$R_{th2}$	0.00608		$C_{th2}$	0.00223	
$R_{th3}$	0.0341		$C_{th3}$	0.00315	
$R_{th4}$	0.0602		$C_{th4}$	0.0179	
$R_{th5}$	0.0884		$C_{th5}$	0.098	
			$C_{th6}$	4.4 <sup>5)</sup>	

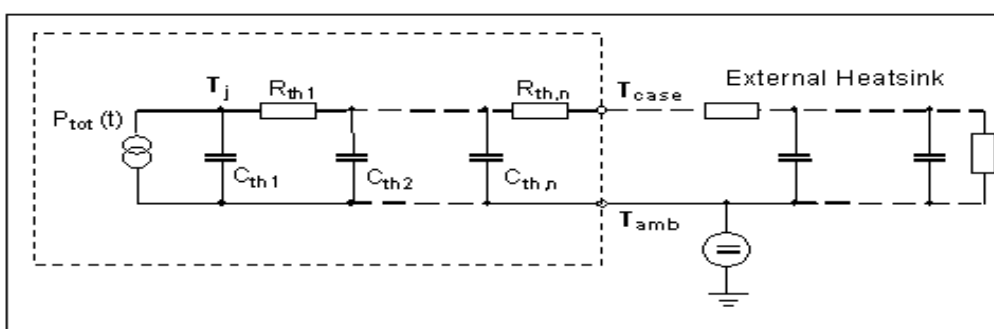

<sup>5)</sup>  $C_{th6}$  models the additional heat capacitance of the package in case of non-ideal cooling. It is not needed if  $R_{thCA}=0\text{ K/W}$ .

**1 Power dissipation**

$$P_{tot}=f(T_C)$$

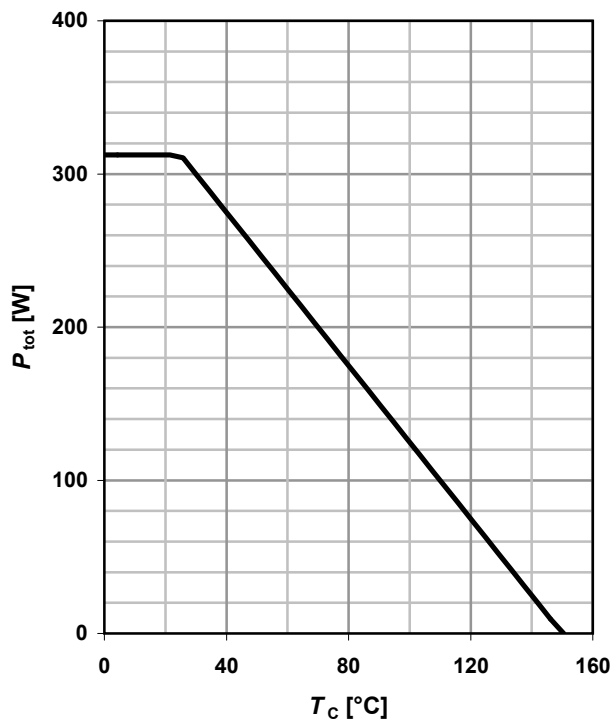
**2 Safe operating area**

$$I_D=f(V_{DS}); T_C=25\text{ }^\circ\text{C}; D=0$$

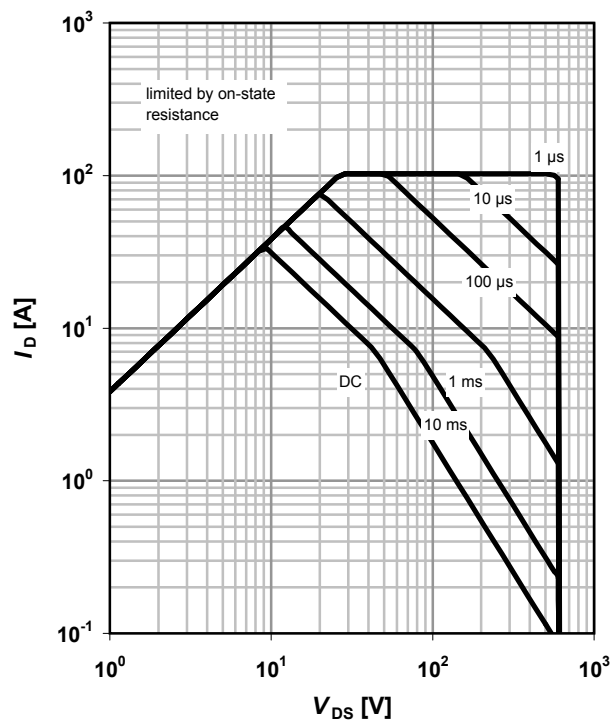
 parameter:  $t_p$ 

**3 Max. transient thermal impedance**

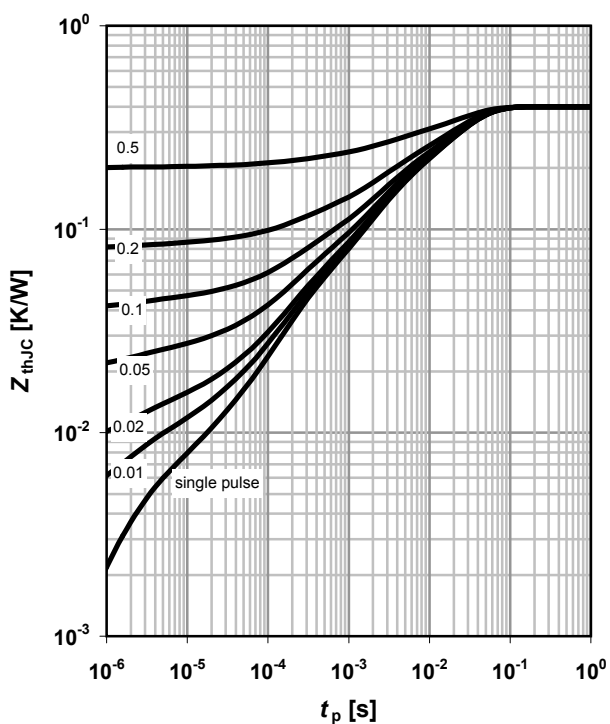
$$I_D=f(V_{DS}); T_j=25\text{ }^\circ\text{C}$$

 parameter:  $D=t_p/T$ 

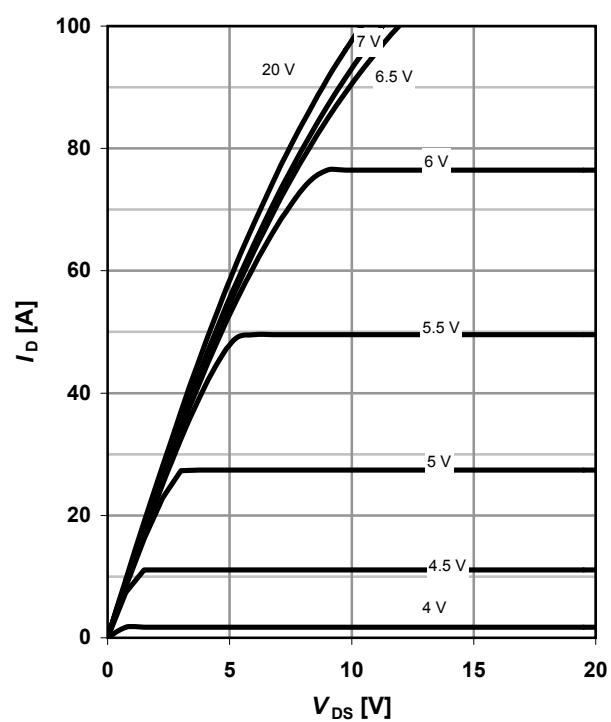
**4 Typ. output characteristics**

$$I_D=f(V_{DS}); T_j=25\text{ }^\circ\text{C}$$

 parameter:  $V_{GS}$ 

**5 Typ. output characteristics**

$I_D = f(V_{DS}); T_j = 150\text{ }^\circ\text{C}$

parameter:  $V_{GS}$

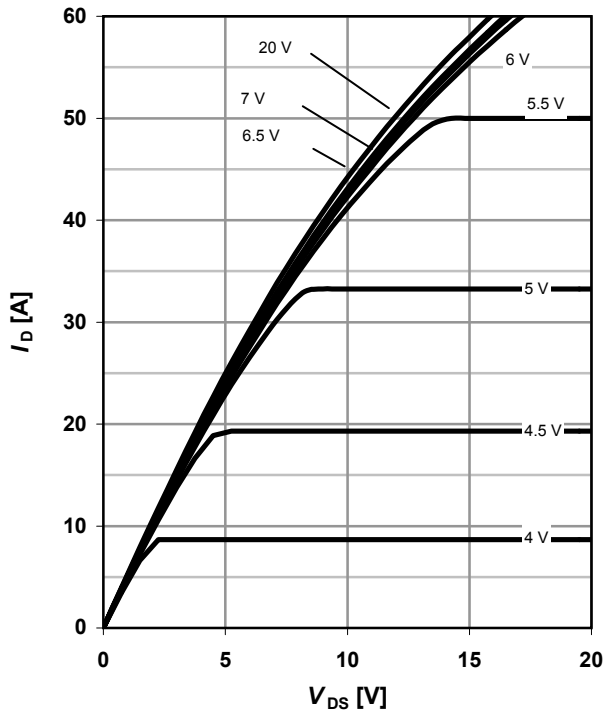

**6 Typ. drain-source on-state resistance**

$R_{DS(on)} = f(I_D); T_j = 150\text{ }^\circ\text{C}$

parameter:  $V_{GS}$

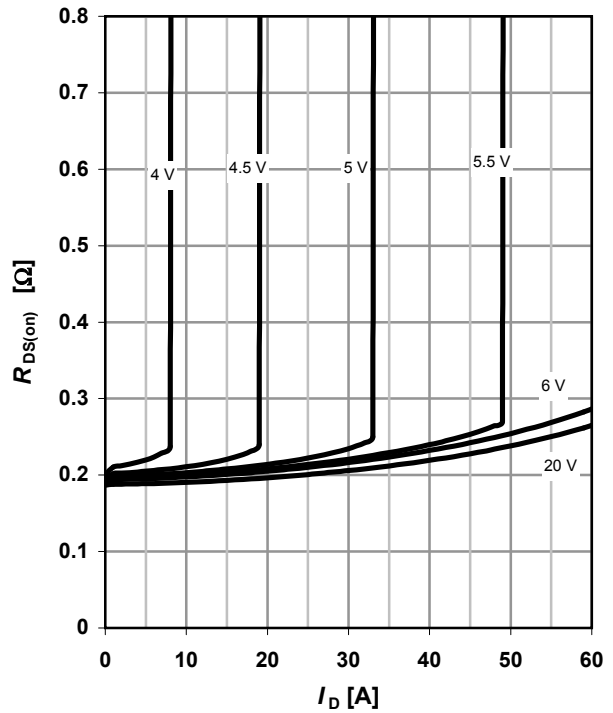

**7 Drain-source on-state resistance**

$R_{DS(on)} = f(T_j); I_D = 21.9\text{ A}; V_{GS} = 10\text{ V}$

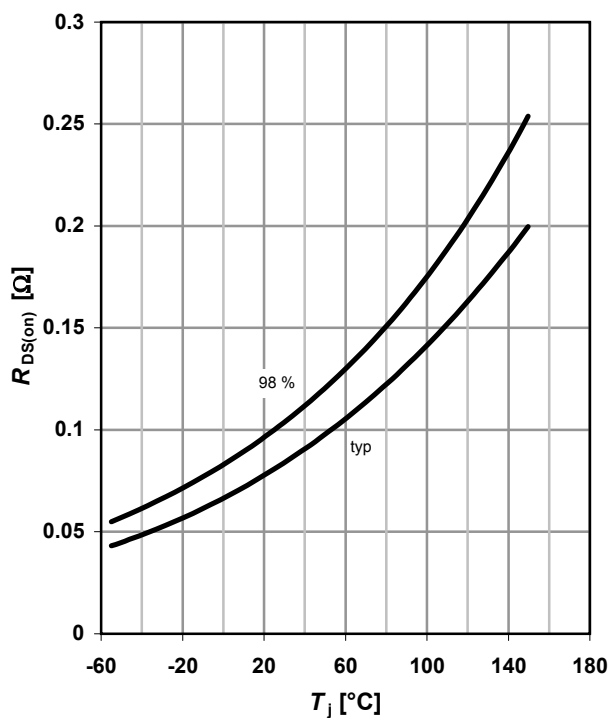

**8 Typ. transfer characteristics**

$I_D = f(V_{GS}); |V_{DS}| > 2|I_D|R_{DS(on)max}$

parameter:  $T_j$

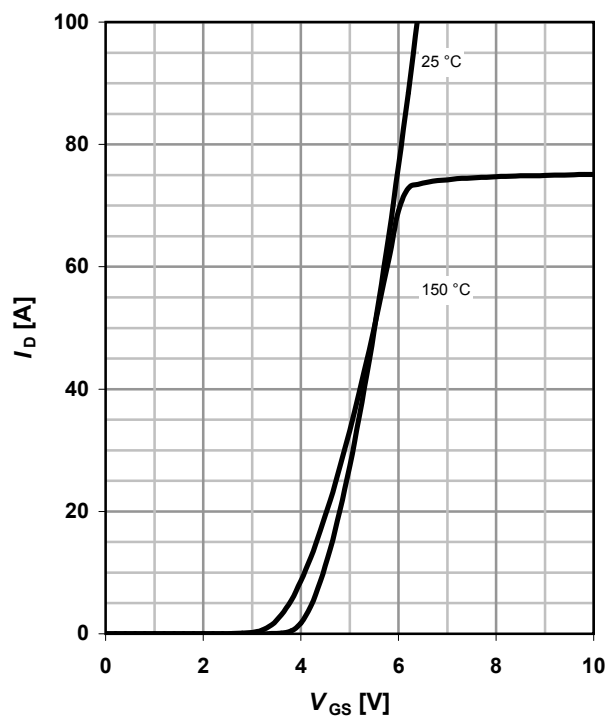

### 9 Typ. gate charge

$V_{GS}=f(Q_{gate}); I_D=34.6 \text{ A pulsed}$

parameter:  $V_{DD}$

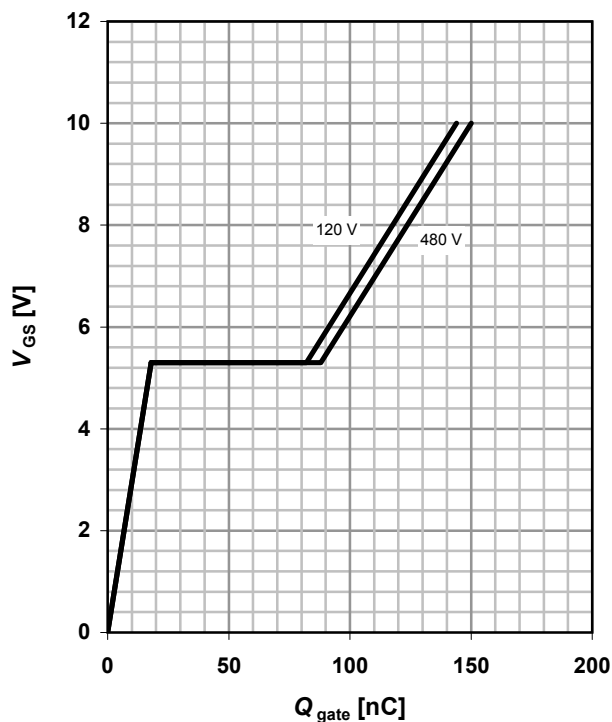

### 10 Forward characteristics of reverse diode

$I_F=f(V_{SD})$

parameter:  $T_j$

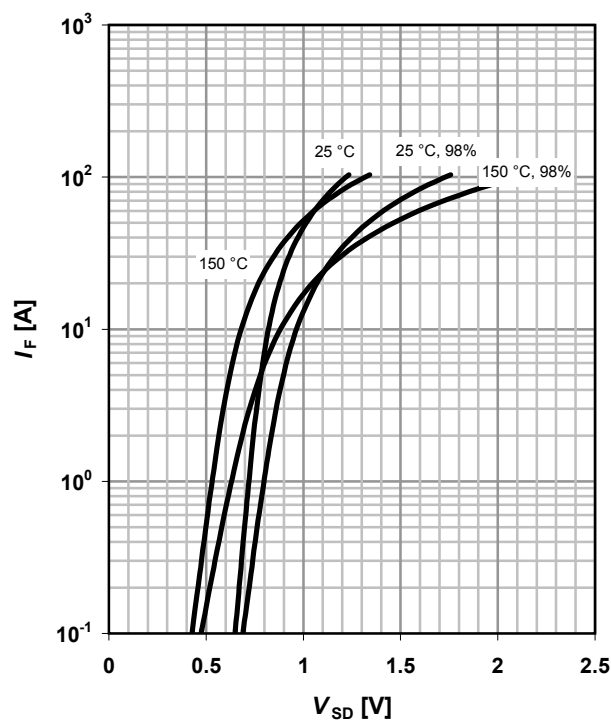

### 11 Avalanche SOA

$I_{AR}=f(t_{AR})$

parameter:  $T_{j(start)}$

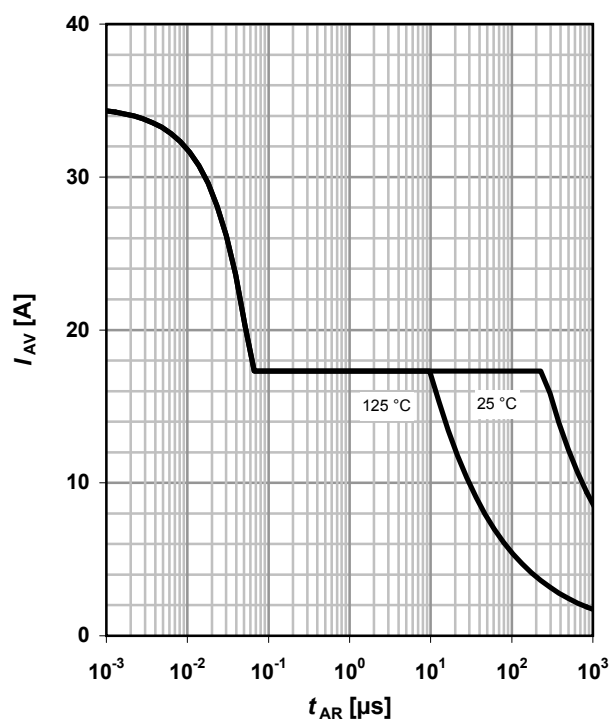

### 12 Avalanche energy

$E_{AS}=f(T_j); I_D=17.3 \text{ A}; V_{DD}=50 \text{ V}$

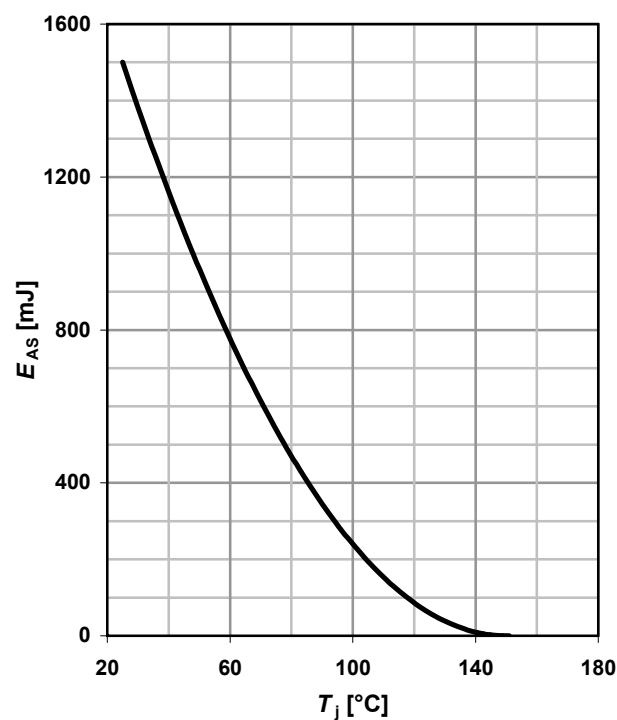

**13 Drain-source breakdown voltage**

$$V_{BR(DSS)} = f(T_j); I_D = 0.25 \text{ mA}$$

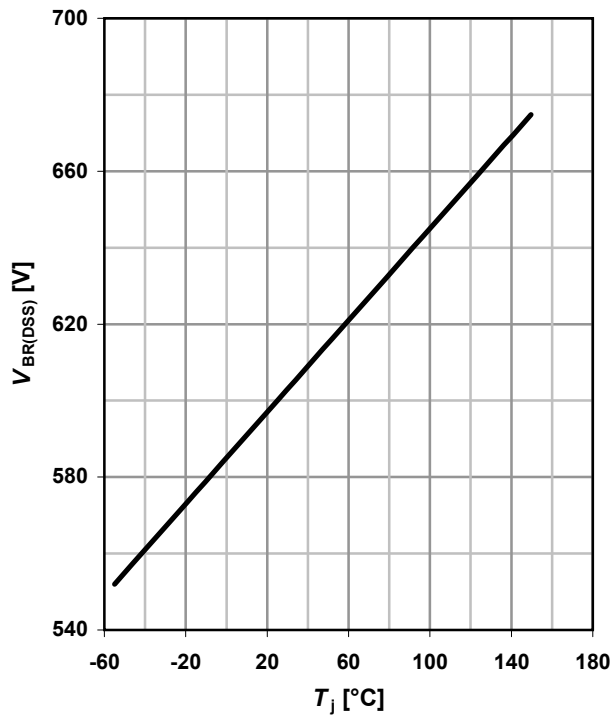

**14 Typ. capacitances**

$$C = f(V_{DS}); V_{GS} = 0 \text{ V}; f = 1 \text{ MHz}$$

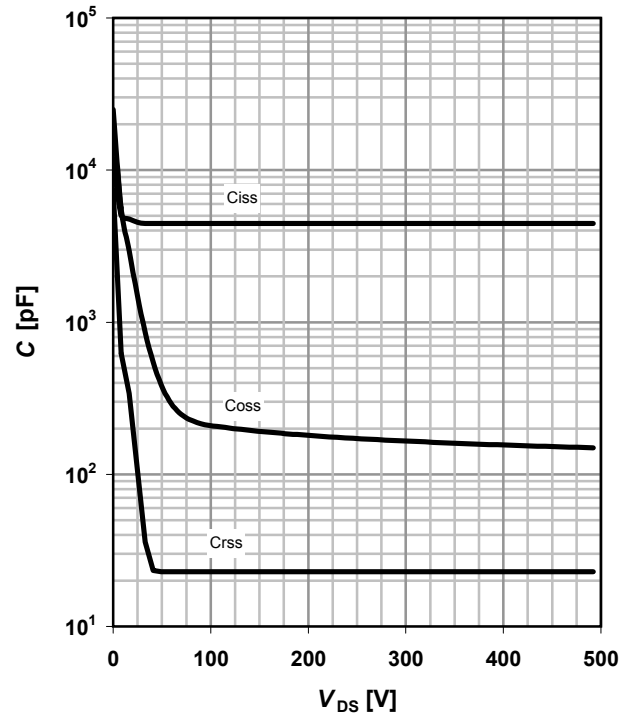

**15 Typ. C<sub>oss</sub> stored energy**

$$E_{oss} = f(V_{DS})$$

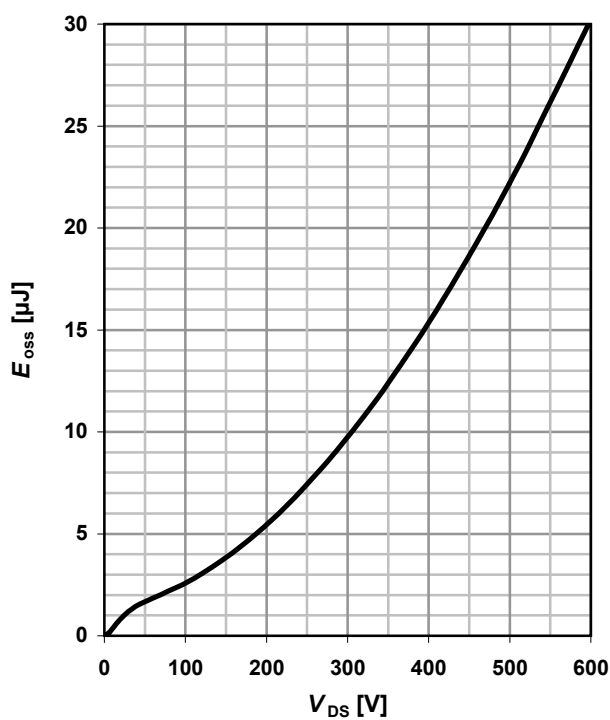



Definition of diode switching characteristics

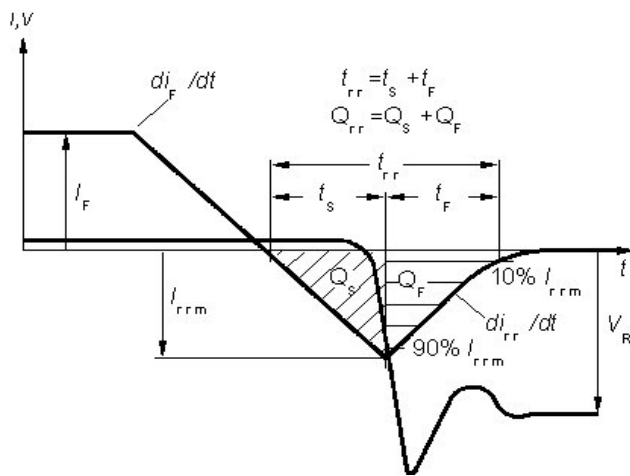

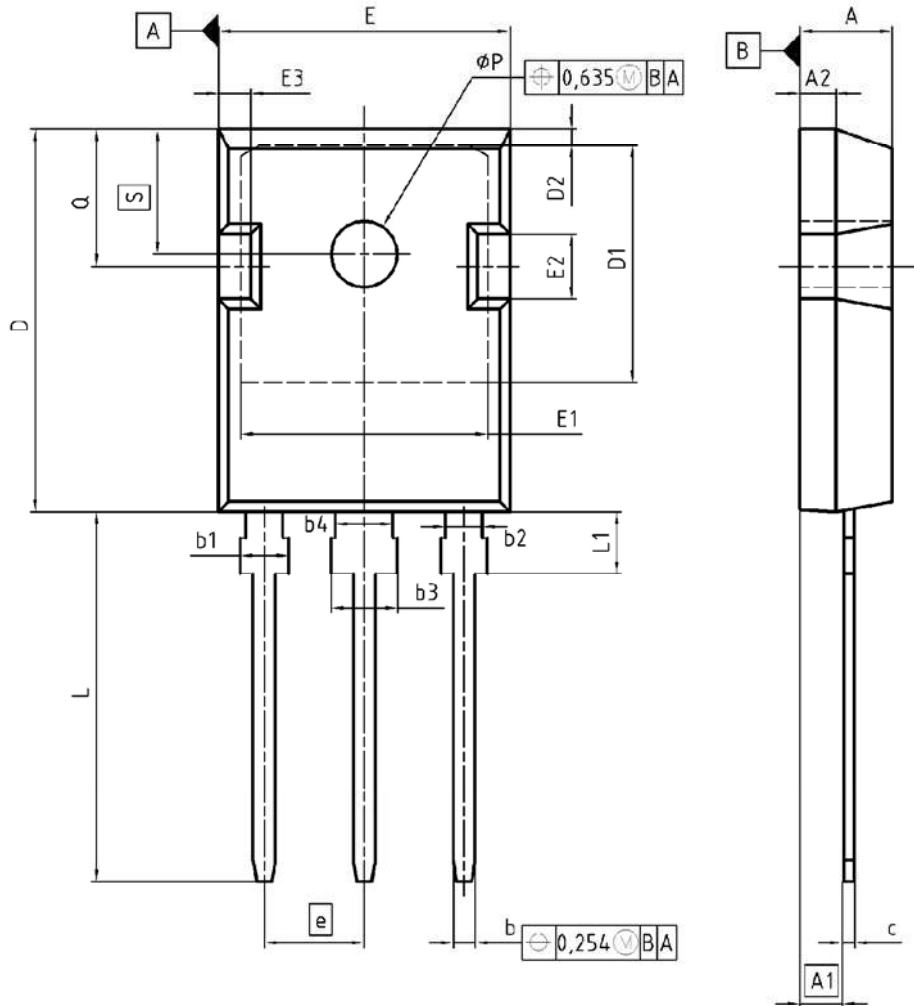

DIM	MILLIMETERS		INCHES	
	MIN	MAX	MIN	MAX
A	4.90	5.16	0.193	0.203
A1	2.27	2.53	0.089	0.099
A2	1.85	2.11	0.073	0.083
b	1.07	1.33	0.042	0.052
b1	1.90	2.41	0.075	0.095
b2	1.90	2.16	0.075	0.085
b3	2.87	3.38	0.113	0.133
b4	2.87	3.13	0.113	0.123
c	0.55	0.68	0.022	0.027
D	20.82	21.10	0.820	0.831
D1	16.25	17.65	0.640	0.695
D2	1.05	1.35	0.041	0.053
E	15.70	16.03	0.618	0.631
E1	13.10	14.15	0.516	0.557
E2	3.68	5.10	0.145	0.201
E3	1.68	2.60	0.066	0.102
e	5.44		0.214	
N	3		3	
L	19.80	20.31	0.780	0.799
L1	4.17	4.47	0.164	0.176
phi P	3.50	3.70	0.138	0.146
Q	5.49	6.00	0.216	0.236
S	6.04	6.30	0.238	0.248

DOCUMENT NO.  
Z8B0C003327

SCALE

EUROPEAN PROJECTION

ISSUE DATE  
17-12-2007

REVISION  
03

**Published by**  
**Infineon Technologies AG**  
**81726 Munich, Germany**  
**© 2008 Infineon Technologies AG**  
**All Rights Reserved.**

#### **Legal Disclaimer**

The information given in this document shall in no event be regarded as a guarantee of conditions or characteristics. With respect to any examples or hints given herein, any typical values stated herein and/or any information regarding the application of the device, Infineon Technologies hereby disclaims any and all warranties and liabilities of any kind, including without limitation, warranties of non-infringement of intellectual property rights of any third party.

#### **Information**

For further information on technology, delivery terms and conditions and prices, please contact the nearest Infineon Technologies Office ([www.infineon.com](http://www.infineon.com)).

#### **Warnings**

Due to technical requirements, components may contain dangerous substances. For information on the types in question, please contact the nearest Infineon Technologies Office. Infineon Technologies components may be used in life-support devices or systems only with the express written approval of Infineon Technologies, if a failure of such components can reasonably be expected to cause the failure of that life-support device or system or to affect the safety or effectiveness of that device or system. Life support devices or systems are intended to be implanted in the human body or to support and/or maintain and sustain and/or protect human life. If they fail, it is reasonable to assume that the health of the user or other persons may be endangered.

# 1 New package outlines TO-247

Assembly capacity extension for CoolMOSTM technology products assembled in lead-free package PG-TO247-3 at subcontractor ASE (Weihai) Inc., China (Changes are marked in blue.)

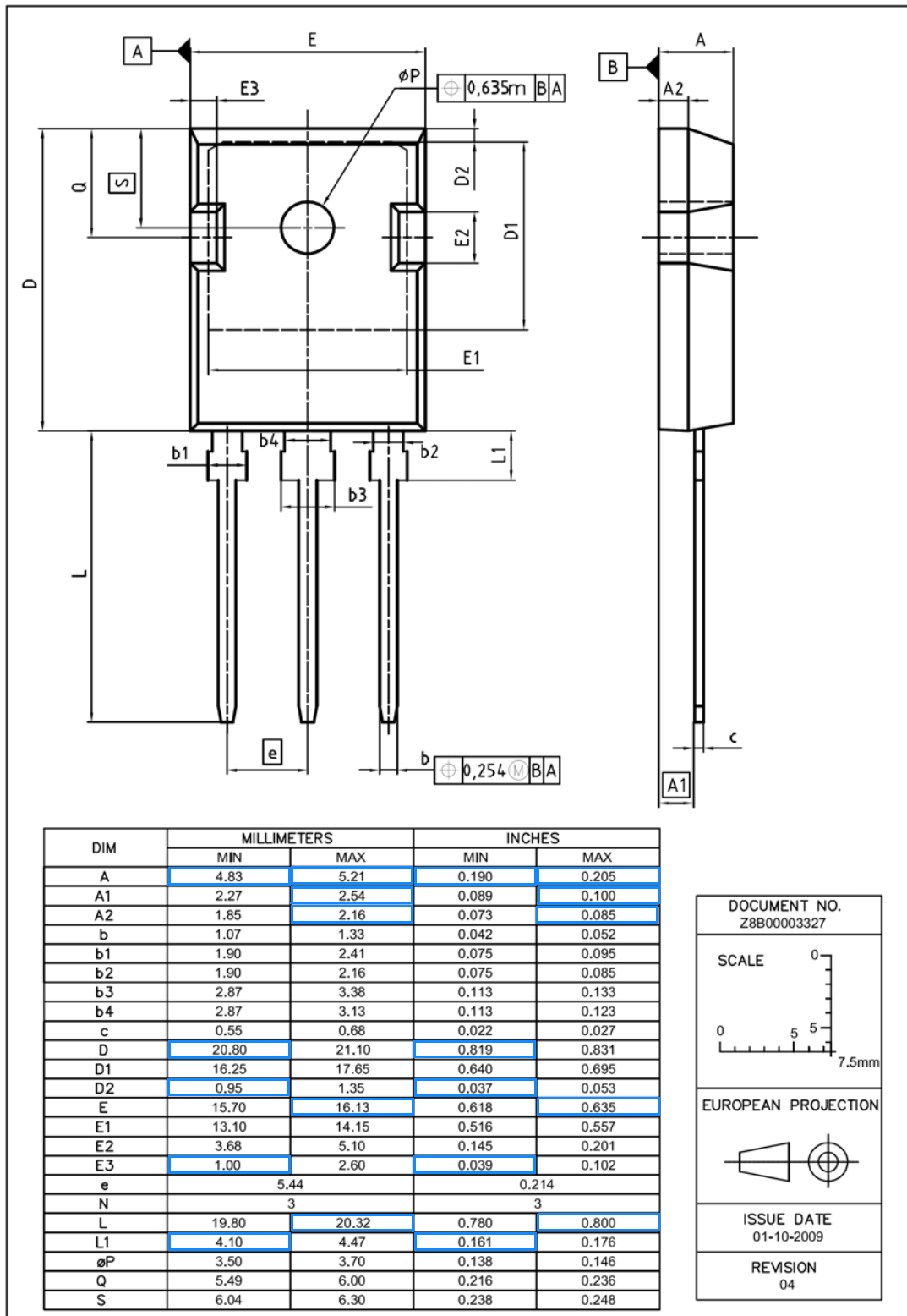

Figure 1 Outlines TO-247, dimensions in mm/inches