

SUMMARY

Wires

Low voltage 5



Image is for illustrative purpose only

Series	1M
Termination type	Female print PCB
IP rating	68 mated (mating interface)
AWG wire size	30.00 - 22.00
Cable Ø	0.00 - 0.00 mm
Status	active
Matching parts	FMN.1M.305.XLC

Download

- [Request a quote](#)
- [PCB Eagle Pattern](#)
- [PCB Altium Pattern](#)
- [PCB KiCad Pattern](#)
- [Catalog](#)

TECHNICAL DETAILS

Mechanics

Shell Style/Model	HE*: Fixed receptacle, nut fixing for printed circuit, watertight
Keying	3 keys (beta=165, gamma=30, plug: male contacts, receptacle: female contacts)
Housing Material	Aluminium (nickel plated [SAE AMS QQ N 290], anthracite color) shell and nut, other pieces bronze/brass
Variant	P : Watertight unmated (connector to device)
Weight	6.90 g

Performance

Configuration	1M.305 : 5 Low Voltage
Insulator	L: PEEK
Rated Current	9.0 Amps

Specifications

- Contact Type: Print (straight)
- Contact Dia.: 0.9 mm (0.035in)
- R (max): 4.8 mOhm
- Test voltage (kV rms) Contact-contact: 1.3
- Test voltage (kV rms) Contact-shell: 1.3

LEMO products and services are provided "as is". LEMO makes no warranties or representations with regard to LEMO product & services or use of them, express, implied or statutory, including for accuracy, completeness, or security. The user is fully responsible for his products and applications using LEMO components.

Others

Endurance (Shell): 3000 mating cycles

Temp (min / max): -20°C / +80°C

Humidity (max): 21 days at 95%

Gunfire vibration: 25 Hz - 2000 Hz, 3 axis (Apache helicopter)

Vibration-Sine: 30 g, 3 axes, 12 hr [10 Hz - 2000 Hz]

Vibration-Random: 37.8 g rms - 3 axes, 4 hr amb [50 Hz - 2000 Hz]

Shock Resistance: 300 g [3 ms]

Lighting strike EIA 364-75: 10K amps - 6 times

EMI Shielding EIA 364-66A: >= 80 dB (1 GHz), >=70 dB (3 GHz), >= 58 dB (6 GHz), >= 40 dB (10 GHz)

Salt Spray Corrosion: max. 48 hr

DRAWINGS

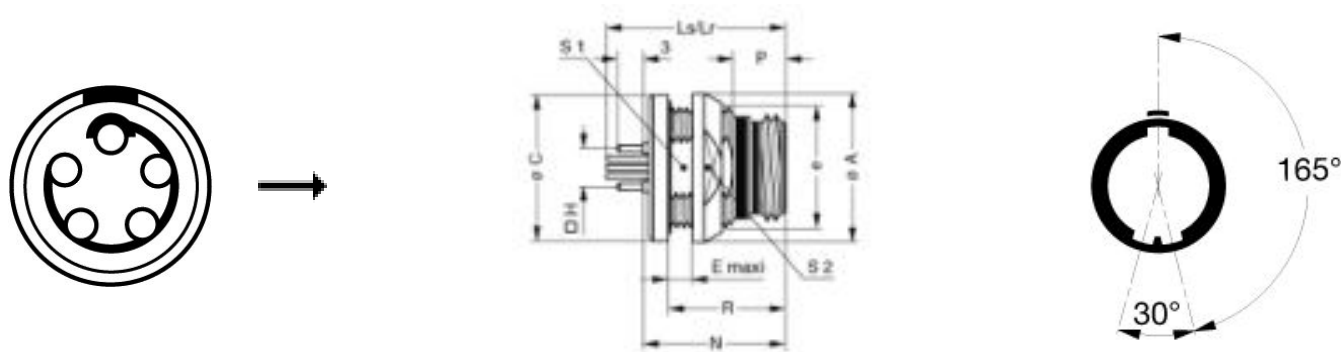

Dimensions

	A	C	E	H	Lr	Ls	N	P	R	S1	S2	e
mm.	18	17.8	5	7.62	21	20.8	16.8	5.3	13.8	12.5	16	M14x1.00
in.	0,71	0,70	0,20	0,30	0,83	0,82	0,66	0,21	0,54	0,49	0,63	

RECOMMENDED BY LEMO

Tools

Spanner wrench: [Socket for torque wrench DCM.65.160.AZ](#)

LEMO products and services are provided "as is". LEMO makes no warranties or representations with regard to LEMO product & services or use of them, express, implied or statutory, including for accuracy, completeness, or security. The user is fully responsible for his products and applications using LEMO components.

LEMO products and services are provided "as is". LEMO makes no warranties or representations with regard to LEMO product & services or use of them, express, implied or statutory, including for accuracy, completeness, or security. The user is fully responsible for his products and applications using LEMO components.