

<p>General Description</p> <ul style="list-style-type: none"> Trench Power MV MOSFET technology Low $R_{DS(ON)}$ Low Gate Charge Optimized for fast-switching applications <p>Applications</p> <ul style="list-style-type: none"> Synchronous Rectification in DC/DC and AC/DC Converters Industrial and Motor Drive applications 	<p>Product Summary</p> <table border="0"> <tr> <td>V_{DS}</td> <td>200V</td> </tr> <tr> <td>I_D (at $V_{GS}=10V$)</td> <td>18A</td> </tr> <tr> <td>$R_{DS(ON)}$ (at $V_{GS}=10V$)</td> <td>< 105mΩ</td> </tr> <tr> <td>$R_{DS(ON)}$ (at $V_{GS}=5V$)</td> <td>< 120mΩ</td> </tr> </table> <p>100% UIS Tested 100% Rg Tested</p> 	V_{DS}	200V	I_D (at $V_{GS}=10V$)	18A	$R_{DS(ON)}$ (at $V_{GS}=10V$)	< 105m Ω	$R_{DS(ON)}$ (at $V_{GS}=5V$)	< 120m Ω
V_{DS}	200V								
I_D (at $V_{GS}=10V$)	18A								
$R_{DS(ON)}$ (at $V_{GS}=10V$)	< 105m Ω								
$R_{DS(ON)}$ (at $V_{GS}=5V$)	< 120m Ω								

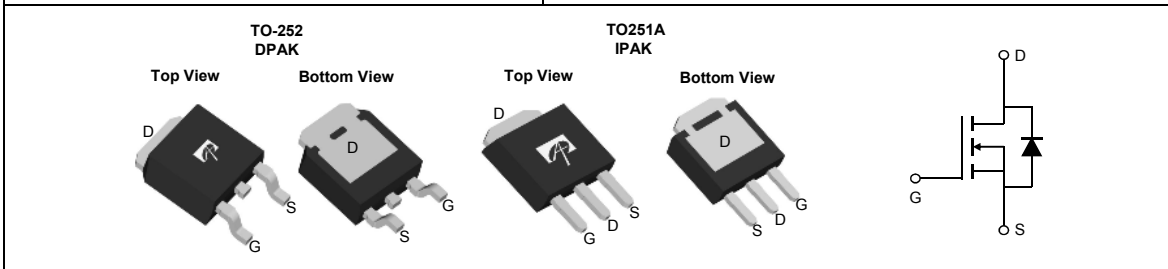

Orderable Part Number	Package Type	Form	Minimum Order Quantity
AOD2210	TO-252	Tape & Reel	2500
AOI2210	TO-251A	Tube	4000

Absolute Maximum Ratings $T_A=25^\circ\text{C}$ unless otherwise noted

Parameter	Symbol	Maximum	Units
Drain-Source Voltage	V_{DS}	200	V
Gate-Source Voltage	V_{GS}	± 20	V
Continuous Drain Current	I_D	$T_C=25^\circ\text{C}$	18
		$T_C=100^\circ\text{C}$	13
Pulsed Drain Current ^C	I_{DM}	45	A
Continuous Drain Current	I_{DSM}	$T_A=25^\circ\text{C}$	3.0
		$T_A=70^\circ\text{C}$	2.5
Avalanche Current ^C	I_{AS}	9	A
Avalanche energy $L=0.1\text{mH}$ ^C	E_{AS}	4	mJ
V_{DS} Spike	V_{SPIKE}	240	V
Power Dissipation ^B	P_D	$T_C=25^\circ\text{C}$	100
		$T_C=100^\circ\text{C}$	50
Power Dissipation ^A	P_{DSM}	$T_A=25^\circ\text{C}$	2.5
		$T_A=70^\circ\text{C}$	1.6
Junction and Storage Temperature Range	T_J, T_{STG}	-55 to 175	$^\circ\text{C}$

Thermal Characteristics

Parameter	Symbol	Typ	Max	Units
Maximum Junction-to-Ambient ^A $t \leq 10\text{s}$	$R_{\theta JA}$	15	20	$^\circ\text{C/W}$
Maximum Junction-to-Ambient ^{A,D} Steady-State		41	50	$^\circ\text{C/W}$
Maximum Junction-to-Case Steady-State	$R_{\theta JC}$	1	1.5	$^\circ\text{C/W}$

Electrical Characteristics (T_J=25°C unless otherwise noted)

Symbol	Parameter	Conditions	Min	Typ	Max	Units
STATIC PARAMETERS						
BV _{DSS}	Drain-Source Breakdown Voltage	I _D =250μA, V _{GS} =0V	200			V
I _{DSS}	Zero Gate Voltage Drain Current	V _{DS} =200V, V _{GS} =0V T _J =55°C			1 5	μA
I _{GSS}	Gate-Body leakage current	V _{DS} =0V, V _{GS} =±20V			±100	nA
V _{GS(th)}	Gate Threshold Voltage	V _{DS} =V _{GS} , I _D =250μA	1.5	2.0	2.5	V
R _{DS(on)}	Static Drain-Source On-Resistance	V _{GS} =10V, I _D =18A T _J =125°C		87	105	mΩ
		V _{GS} =5V, I _D =16A		93	120	
g _{FS}	Forward Transconductance	V _{DS} =5V, I _D =18A		40		S
V _{SD}	Diode Forward Voltage	I _S =1A, V _{GS} =0V		0.7	1	V
I _S	Maximum Body-Diode Continuous Current				18	A
DYNAMIC PARAMETERS						
C _{iss}	Input Capacitance	V _{GS} =0V, V _{DS} =100V, f=1MHz		2065		pF
C _{oss}	Output Capacitance			74		pF
C _{rss}	Reverse Transfer Capacitance			3.8		pF
R _g	Gate resistance	f=1MHz	1.1	2.2	3.3	Ω
SWITCHING PARAMETERS						
Q _{g(10V)}	Total Gate Charge	V _{GS} =10V, V _{DS} =100V, I _D =18A		27	40	nC
Q _{g(4.5V)}	Total Gate Charge			12	20	nC
Q _{gs}	Gate Source Charge			7		nC
Q _{gd}	Gate Drain Charge			3		nC
t _{D(on)}	Turn-On DelayTime	V _{GS} =10V, V _{DS} =100V, R _L =5.5Ω, R _{GEN} =3Ω		8		ns
t _r	Turn-On Rise Time			10		ns
t _{D(off)}	Turn-Off DelayTime			30		ns
t _f	Turn-Off Fall Time			4		ns
t _{rr}	Body Diode Reverse Recovery Time	I _F =18A, dI/dt=500A/μs		60		ns
Q _{rr}	Body Diode Reverse Recovery Charge	I _F =18A, dI/dt=500A/μs		800		nC

A. The value of R_{θJA} is measured with the device mounted on 1 in² FR-4 board with 2oz. Copper, in a still air environment with T_A=25° C. The Power dissipation P_{DSM} is based on R_{θJA} ≤ 10s and the maximum allowed junction temperature of 150° C. The value in any given application depends on the user's specific board design, and the maximum temperature of 175° C may be used if the PCB allows it.

B. The power dissipation P_D is based on T_{J(MAX)}=175° C, using junction-to-case thermal resistance, and is more useful in setting the upper dissipation limit for cases where additional heatsinking is used.

C. Single pulse width limited by junction temperature T_{J(MAX)}=175° C.

D. The R_{θJA} is the sum of the thermal impedance from junction to case R_{θJC} and case to ambient.

E. The static characteristics in Figures 1 to 6 are obtained using <300μs pulses, duty cycle 0.5% max.

F. These curves are based on the junction-to-case thermal impedance which is measured with the device mounted to a large heatsink, assuming a maximum junction temperature of T_{J(MAX)}=175° C. The SOA curve provides a single pulse rating.

G. The maximum current rating is package limited.

H. These tests are performed with the device mounted on 1 in² FR-4 board with 2oz. Copper, in a still air environment with T_A=25° C.

THIS PRODUCT HAS BEEN DESIGNED AND QUALIFIED FOR THE CONSUMER MARKET. APPLICATIONS OR USES AS CRITICAL COMPONENTS IN LIFE SUPPORT DEVICES OR SYSTEMS ARE NOT AUTHORIZED. AOS DOES NOT ASSUME ANY LIABILITY ARISING OUT OF SUCH APPLICATIONS OR USES OF ITS PRODUCTS. AOS RESERVES THE RIGHT TO IMPROVE PRODUCT DESIGN, FUNCTIONS AND RELIABILITY WITHOUT NOTICE.

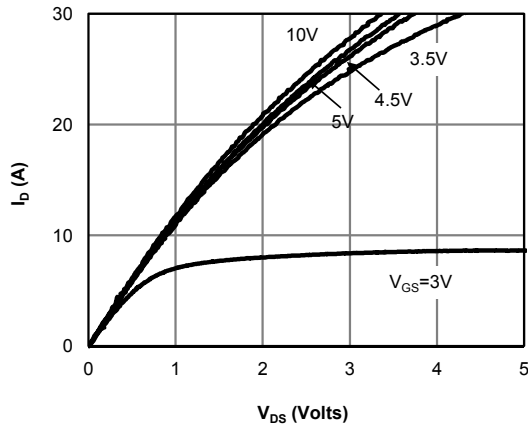
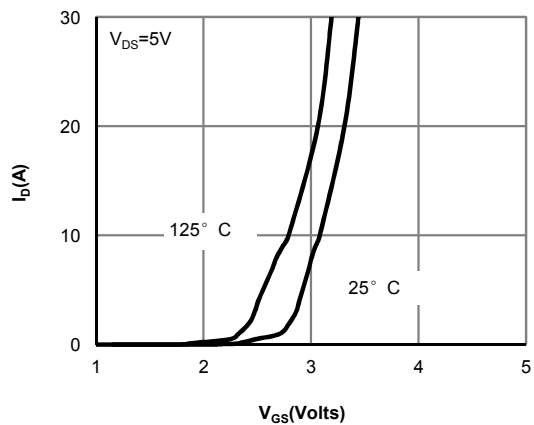
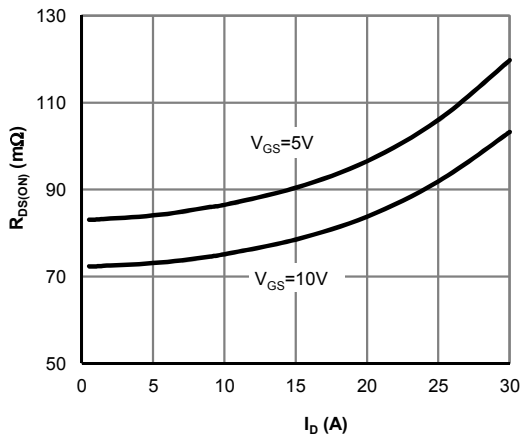
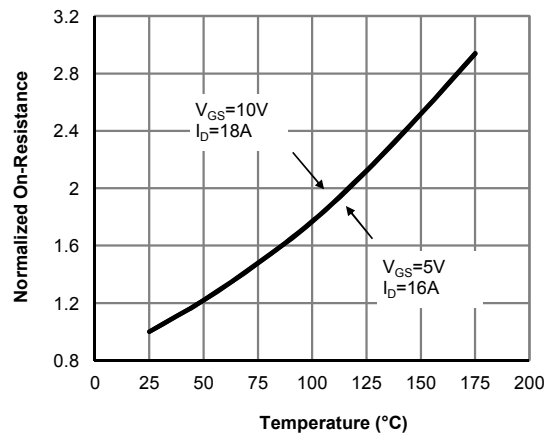
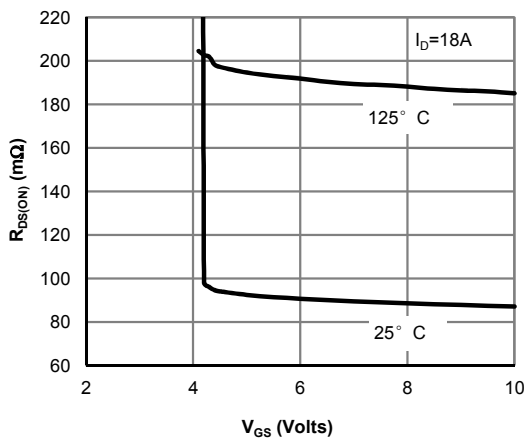
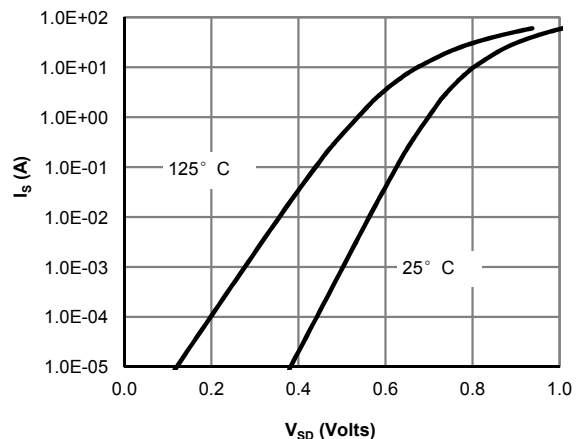
TYPICAL ELECTRICAL AND THERMAL CHARACTERISTICS

Figure 1: On-Region Characteristics (Note E)

Figure 2: Transfer Characteristics (Note E)

Figure 3: On-Resistance vs. Drain Current and Gate Voltage (Note E)

Figure 4: On-Resistance vs. Junction Temperature (Note E)

Figure 5: On-Resistance vs. Gate-Source Voltage (Note E)

Figure 6: Body-Diode Characteristics (Note E)

TYPICAL ELECTRICAL AND THERMAL CHARACTERISTICS

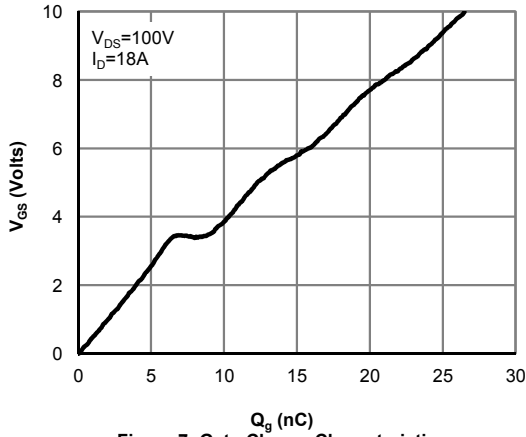

Figure 7: Gate-Charge Characteristics

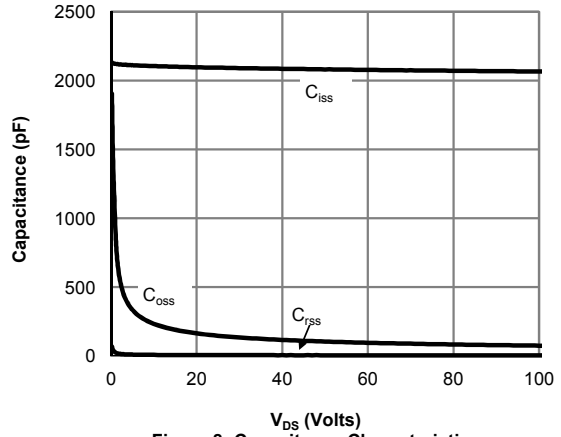

Figure 8: Capacitance Characteristics

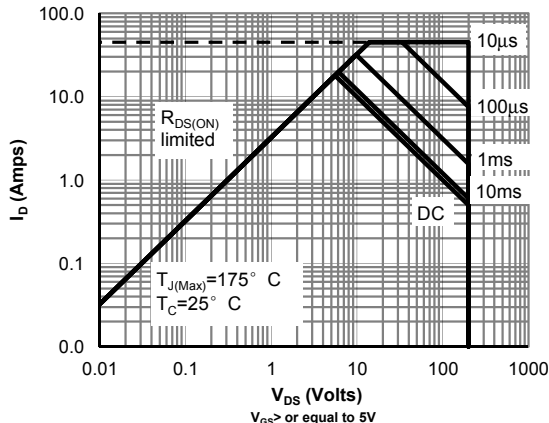

Figure 9: Maximum Forward Biased Safe Operating Area (Note F)

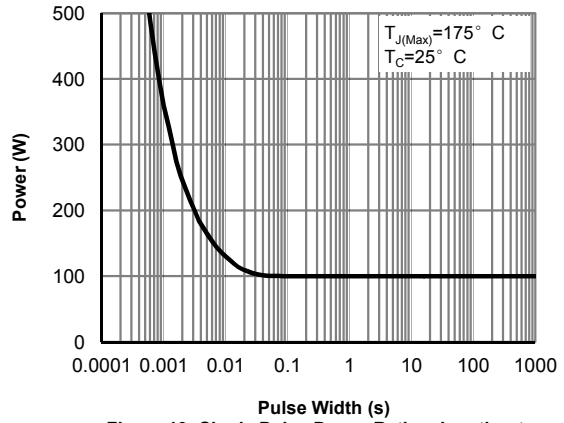

Figure 10: Single Pulse Power Rating Junction-to-Case (Note F)

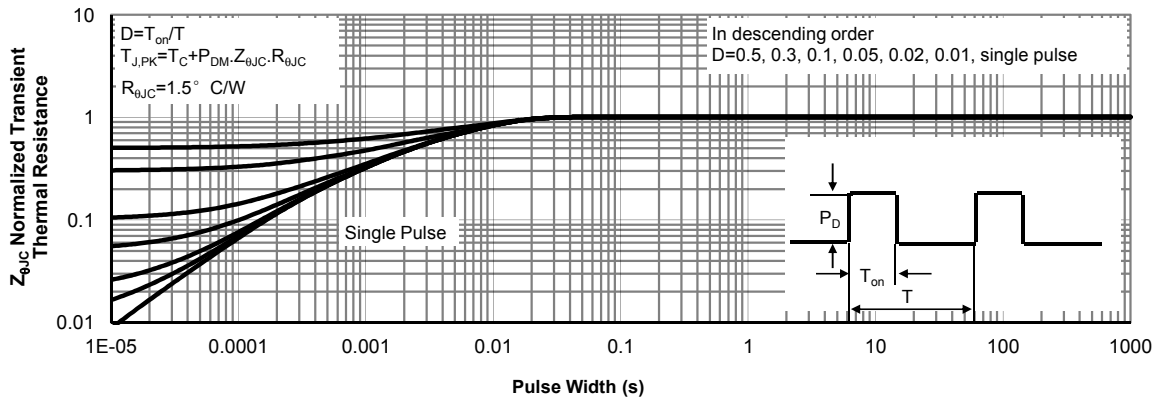

Figure 11: Normalized Maximum Transient Thermal Impedance (Note F)

TYPICAL ELECTRICAL AND THERMAL CHARACTERISTICS

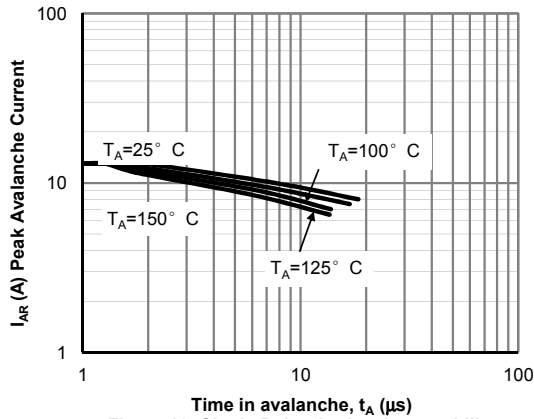

Figure 12: Single Pulse Avalanche capability (Note C)

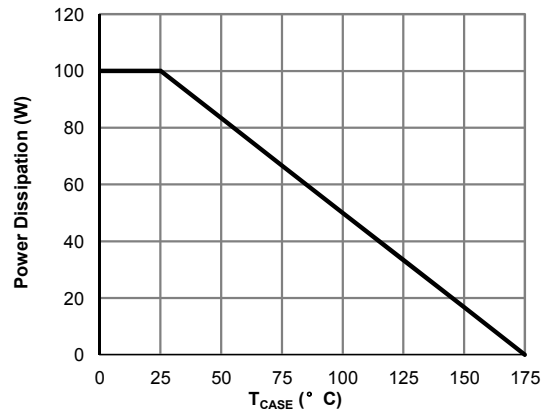

Figure 13: Power De-rating (Note F)

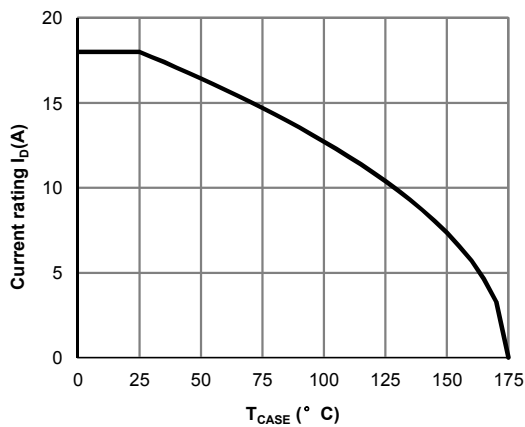

Figure 14: Current De-rating (Note F)

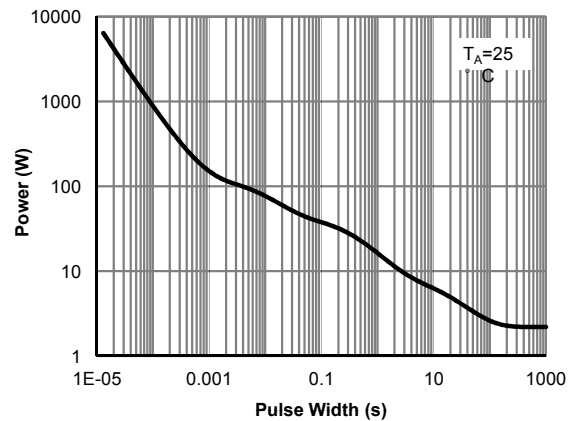

Figure 15: Single Pulse Power Rating Junction-to-Ambient (Note H)

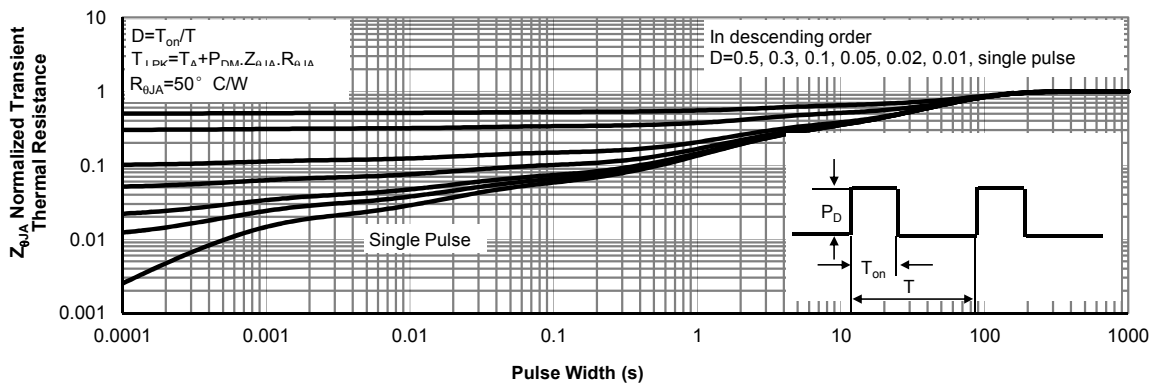
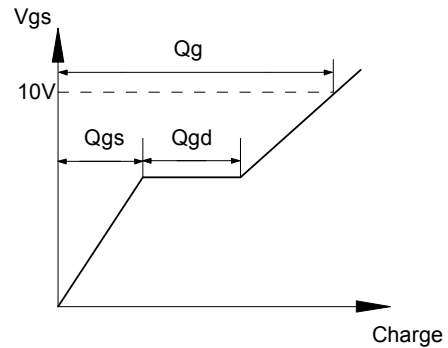
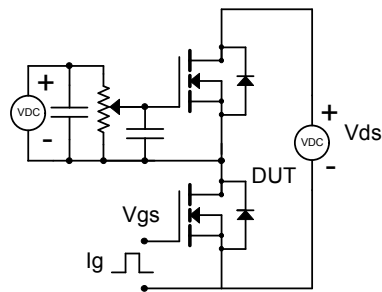
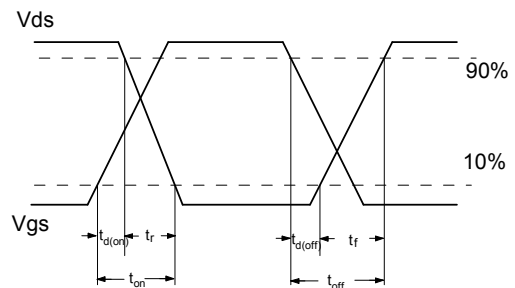
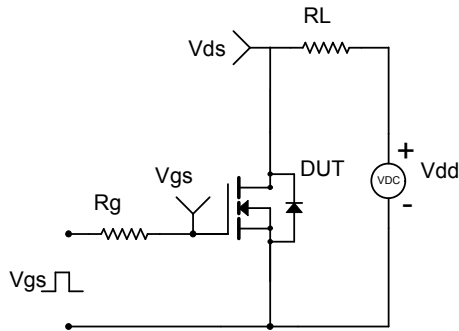

Figure 16: Normalized Maximum Transient Thermal Impedance (Note H)

Gate Charge Test Circuit & Waveform



Resistive Switching Test Circuit & Waveforms



Unclamped Inductive Switching (UIS) Test Circuit & Waveforms

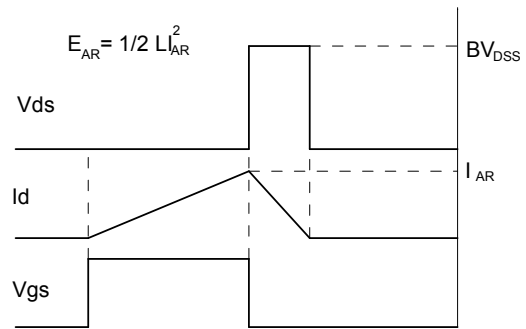
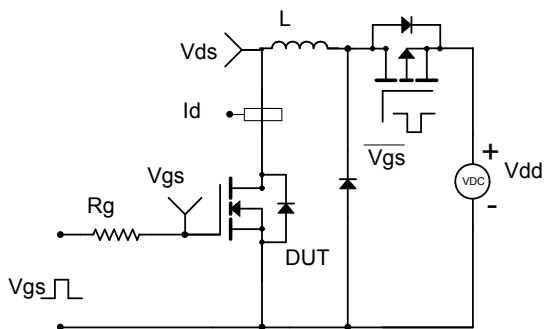

Diode Recovery Test Circuit & Waveforms

