



ESDALC14V2-2BP5 ESDALC25-2BP5

Low capacitance TRANSIL™ array for ESD protection

Main applications

Where transient overvoltage protection in ESD sensitive equipment is required, such as :

- Computers
- Printers
- Communication systems such as xDSL modem
- Video equipment

This device is particularly adapted to the protection of symmetrical systems

Features

- 2 Bidirectional Transil functions
- Breakdown voltage:
 $V_{BR} = 14.2 \text{ V}$ and 25 V minimum
- Low leakage current: $< 1 \mu\text{A}$
- Low diode capacitance: 14 and 8 pF at 3 V
- Very small PCB area $< 2.6 \text{ mm}^2$

Description

The ESDALCxx-2BP5 is a monolithic array designed to protect up to 2 lines against ESD transients.

The device is ideal for situations where board space saving is required.

Benefits

- High ESD protection level
- High integration
- Suitable for high density boards

TM: TRANSIL is a trademark of STMicroelectronics

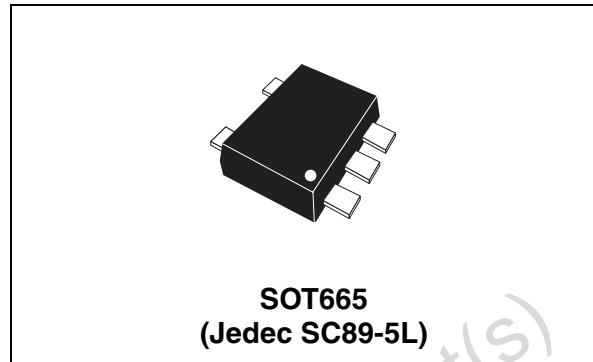

Order codes

Part Number	Marking
ESDALC14V2-2BP5	A3
ESDALC25-2BP5	A4

ESDALCxx-2BP5 Functional diagram

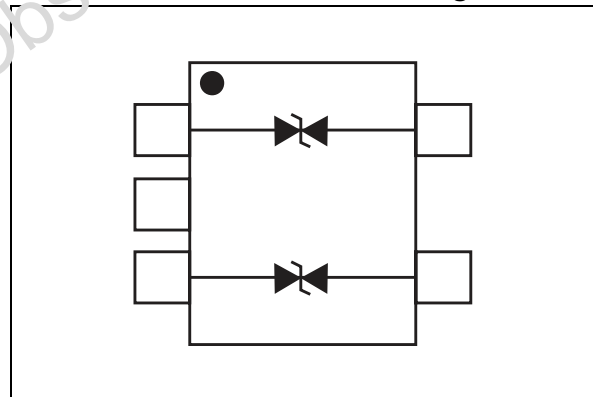

Complies with the following standards

IEC61000-4-2

Level 4 15 kV (air discharge)
 8 kV (contact discharge)

MIL STD 883E - Method 3015-7 Class 3

25 kV HBM (Human Body Model)

1 Characteristics

Table 1. Absolute Ratings ($T_{amb} = 25^{\circ}\text{C}$)

Symbol	Parameter	Value	Unit
P_{PP}	Peak pulse power (8/20 μs) ⁽¹⁾	50	W
T_j	Junction temperature	150	$^{\circ}\text{C}$
T_{stg}	Storage temperature range	-55 to +150	$^{\circ}\text{C}$
T_L	Maximum lead temperature for soldering during 10s	260	$^{\circ}\text{C}$
T_{op}	Operating temperature range ⁽²⁾	-40 to +150	$^{\circ}\text{C}$

1. For a surge greater than the maximum values, the diode will fail in short circuit
2. The values of the operating parameters versus temperature are given through curves and αT parameter.

1.1 Electrical characteristics ($T_{amb} = 25^{\circ}\text{C}$)

Symbol	Parameter
V_{RM}	Stand-off voltage
V_{BR}	Breakdown voltage
V_{CL}	Clamping voltage
I_{RM}	Leakage current
I_{PP}	Peak pulse current
αT	Voltage temperature coefficient
V_F	Forward voltage drop
C	Capacitance
R_d	Dynamic resistance

Part Numbers	$V_{BR} @ I_R$		$I_{RM} @ V_{RM}$		R_d typ.	αT max.	C typ. 3V bias	
	min.	max.	max.					
	V	V	mA	μA	V	Ω	10^{-4}°C	pF
ESDALC14V2-2BP5	14.2	18	1	1	12	1.5	7	14
ESDALC25-2BP5	25	29.7	1	1	24	1.3	8	8

Figure 1. Peak pulse power versus initial junction temperature

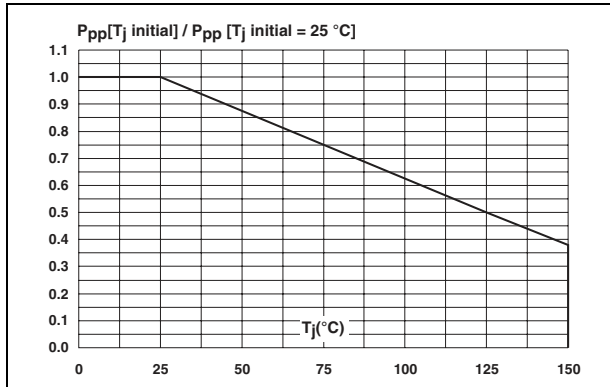

Figure 2. Peak pulse power versus exponential pulse duration

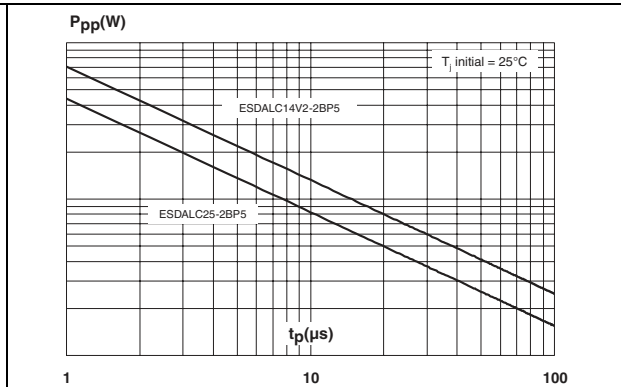

Figure 3. Clamping voltage versus peak pulse current (maximum values, rectangular waveform)

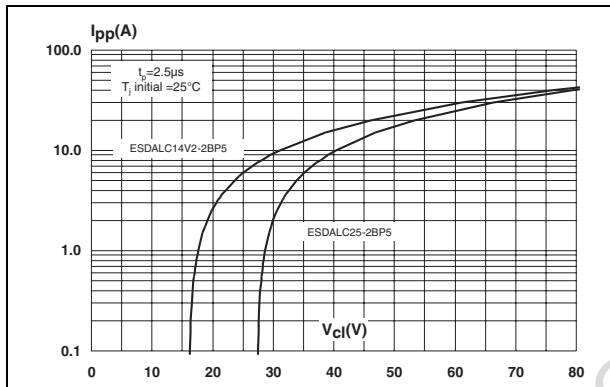

Figure 4. Junction capacitance versus reverse applied voltage (typical values)

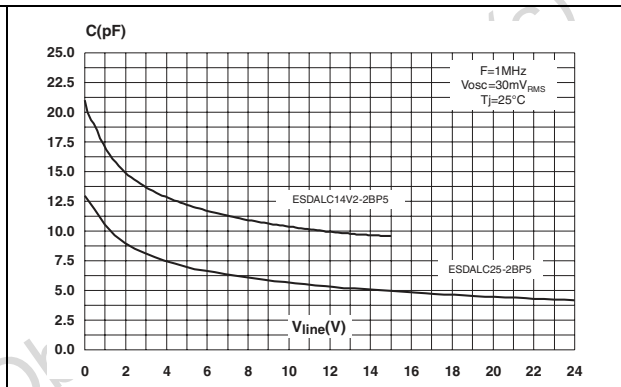

Figure 5. Relative variation of leakage current versus junction temperature (typical values)

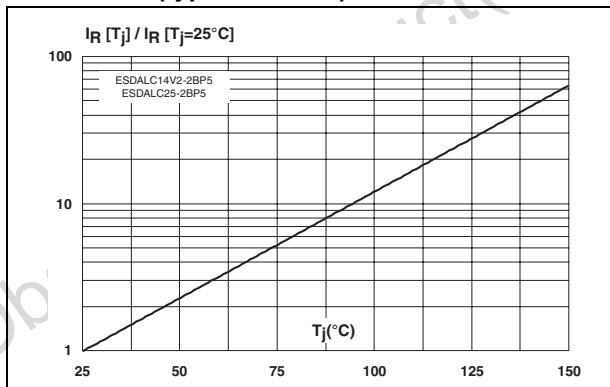
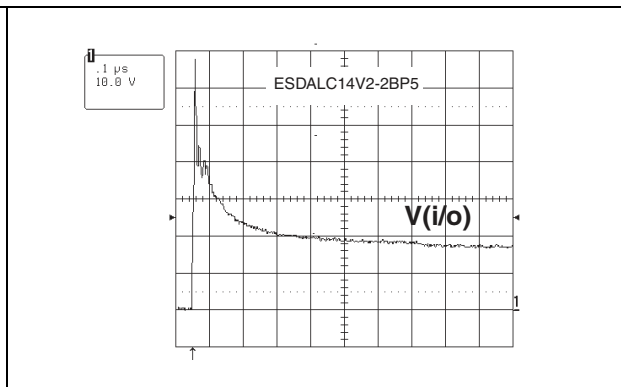
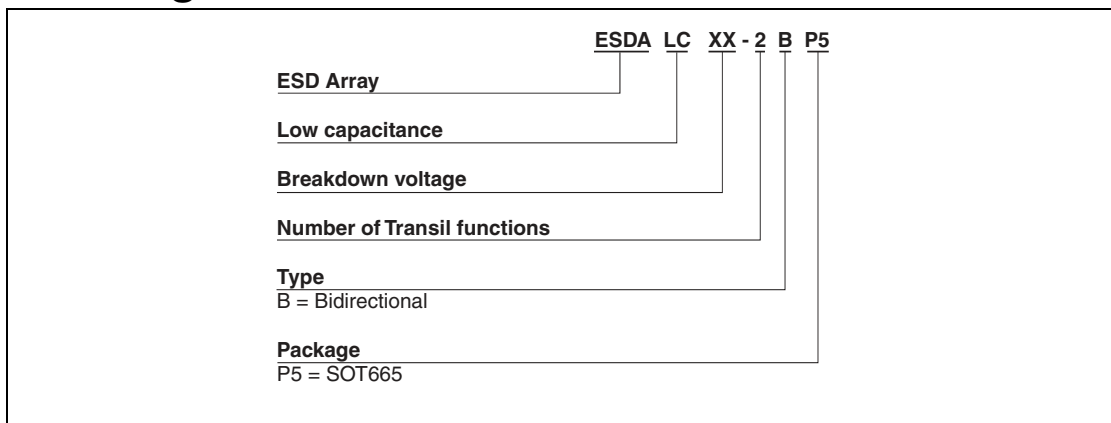

Figure 6. ESD response to IEC61000-4-2 (air discharge 15kV, positive surge)



2 Ordering information scheme



3 Package mechanical data

3.1 SOT665 package

REF.	DIMENSIONS			
	Millimeters		Inches	
	Min.	Max.	Min.	Max.
A	0.50	0.60	0.020	0.024
bp	0.17	0.27	0.007	0.011
c	0.08	0.18	0.003	0.007
D	1.50	1.70	0.060	0.067
E	1.10	1.30	0.043	0.051
e	1.00		0.040	
e1	0.50		0.020	
He	1.50	1.70	0.059	0.067
Lp	0.10	0.30	0.004	0.012

Figure 7. Footprint dimensions

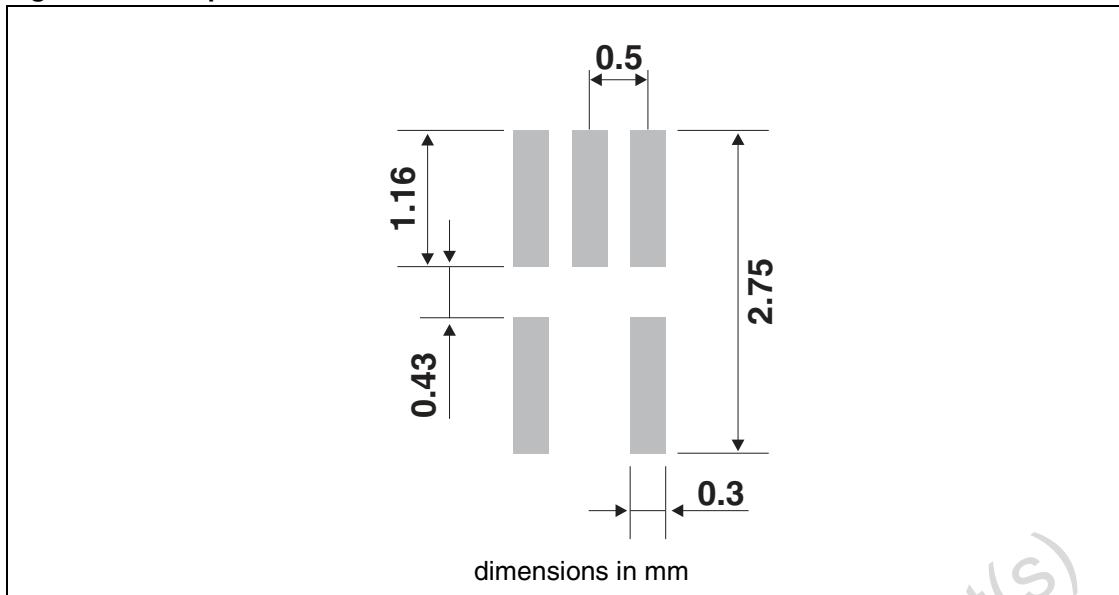

In order to meet environmental requirements, ST offers these devices in ECOPACK® packages. These packages have a Lead-free second level interconnect . The category of second level interconnect is marked on the package and on the inner box label, in compliance with JEDEC Standard JESD97. The maximum ratings related to soldering conditions are also marked on the inner box label. ECOPACK is an ST trademark. ECOPACK specifications are available at: www.st.com.

4 Ordering information

Part Number	Marking	Package	Weight	Base qty	Delivery mode
ESDALC14V2-2BP5	A3	SOT665	2.9 mg	3000	Tape & reel
ESDALC25-2BP5	A4				

5 Revision history

Date	Revision	Changes
08-Dec-2005	1	First issue

Information furnished is believed to be accurate and reliable. However, STMicroelectronics assumes no responsibility for the consequences of use of such information nor for any infringement of patents or other rights of third parties which may result from its use. No license is granted by implication or otherwise under any patent or patent rights of STMicroelectronics. Specifications mentioned in this publication are subject to change without notice. This publication supersedes and replaces all information previously supplied. STMicroelectronics products are not authorized for use as critical components in life support devices or systems without express written approval of STMicroelectronics.



The ST logo is a registered trademark of STMicroelectronics.
All other names are the property of their respective owners

© 2005 STMicroelectronics - All rights reserved

STMicroelectronics group of companies

Australia - Belgium - Brazil - Canada - China - Czech Republic - Finland - France - Germany - Hong Kong - India - Israel - Italy - Japan -
Malaysia - Malta - Morocco - Singapore - Spain - Sweden - Switzerland - United Kingdom - United States of America

www.st.com