

1:1 Transmission Line Balun with Tertiary Winding 5 - 1225 MHz

Rev. V4

Features

- Surface Mount
- 1:1 Impedance
- Available on Tape and Reel
- RoHS Compliant and Pb Free
- 260°C Reflow Compatible
- Excellent Temperature Stability

Description

The MABA-011085 is a 1:1 transmission line balun with tertiary winding in a low cost surface mount package.

Ideally suited for all CATV Broadband and FTTx applications.

Functional Schematic

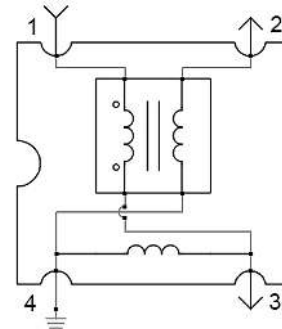

Pin Configuration

Pin #	Function	Pin #	Function
1	Primary (input)	3	Secondary (output 1)
2	Secondary (output 2)	4	Primary (ground)

Electrical Specifications: Freq. = 5 - 1225 MHz, T_A = 25°C, Z₀ = 75 Ω, P_{IN} = 0 dBm

Parameter	Test Conditions Frequency (MHz)	Units	Min.	Typ.	Max.
Impedance Ratio	—	—	—	1:1	—
Insertion Loss 1 (Pin 1 - Pin 3)	5 - 300	dB	—	0.2	0.4
	300 - 1000			0.4	0.8
	1000 - 1225			0.7	1.0
Insertion Loss 2 (Pin 1 - Pin 2)	5 - 300	dB	—	0.4	0.7
	300 - 1000			0.6	0.9
	1000 - 1225			0.7	0.9
Amplitude Balance	5 - 300	dB	—	0.2	±0.4
	300 - 1225			0.1	±0.5
Phase Balance (ref value 180°)	5 - 300	dB	—	1.0	±4.0
	300 - 1225			2.0	±9.0
Input Return Loss (Pin 1)	5 - 300	dB	23	28	—
	300 - 1225		15	23	

Ordering Information¹

Part Number	Description
MABA-011085	900 piece reel
MABA-011085-TB	Sample Board

1. All sample boards include 5 loose parts.

Absolute Maximum Ratings^{2,3}

Parameter	Absolute Maximum
Input RF Power ⁴	2000 mW
DC Current	1500 mA
Operating Temperature	-40°C to +125°C

- Exceeding any one or combination of these limits may cause permanent damage to this device.
- MACOM does not recommend sustained operation near these survivability limits.
- Specified at +25°C only.

Recommended PCB Layout^{5,6,7,8}

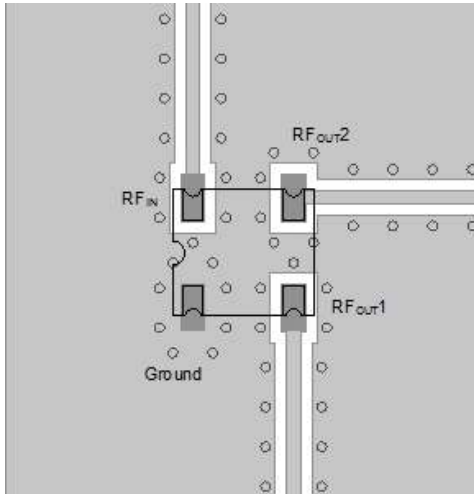

Layout Option 1 - no dc voltage on tertiary winding

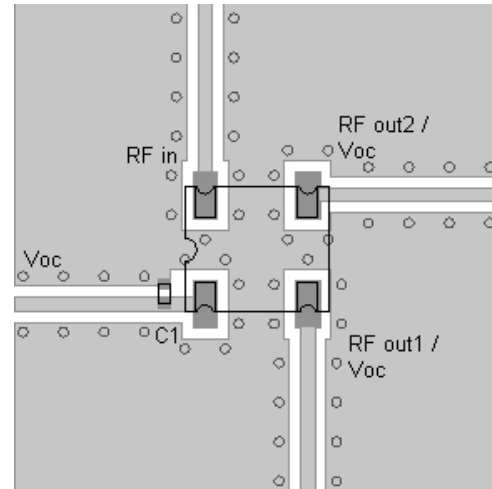

Layout Option 2 - dc voltage on tertiary winding

- 5. Recommended PCB layout shown above uses 1.6 mm FR4.
- 6. Grounded coplanar wave guide transmission line.
- 7. Trace width 0.70 mm.
- 8. Gap 0.57 mm.

Application Schematics

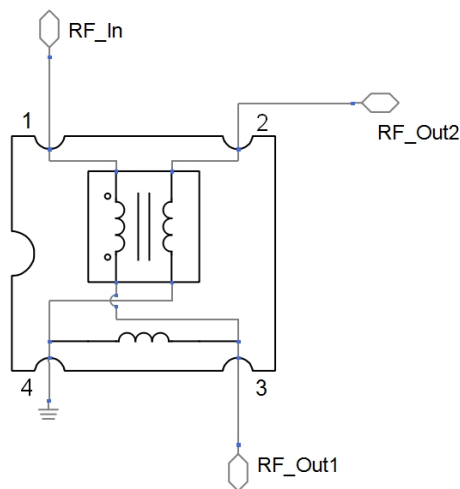

Option 1 - no dc voltage on tertiary winding

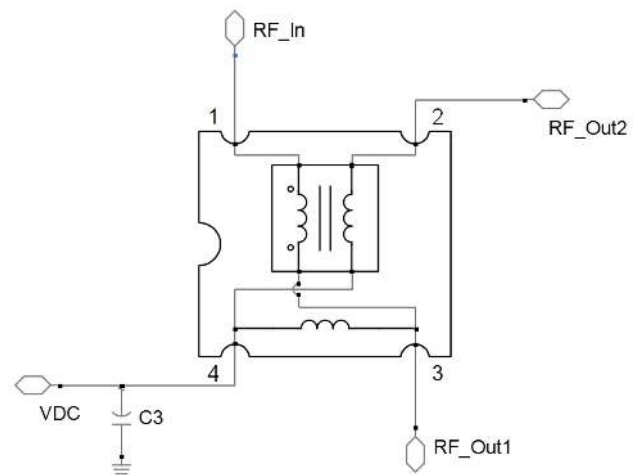

Option 2 - dc voltage on tertiary winding

Parts List

Component	Value	Package
C1	10 nF	0402

1:1 Transmission Line Balun with Tertiary Winding 5 - 1225 MHz

Rev. V4

Typical Performance Curves: $T_A = 25^\circ\text{C}$, $Z_0 = 75 \Omega$, $P_{IN} = 0 \text{ dBm}$

Insertion Loss (pin 1-3)

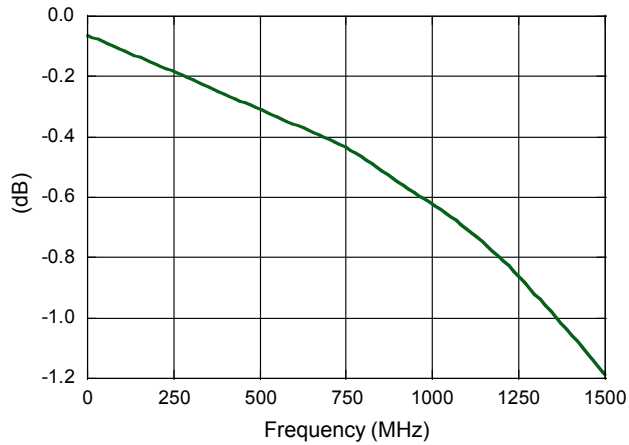

Insertion Loss (pin 1-2)

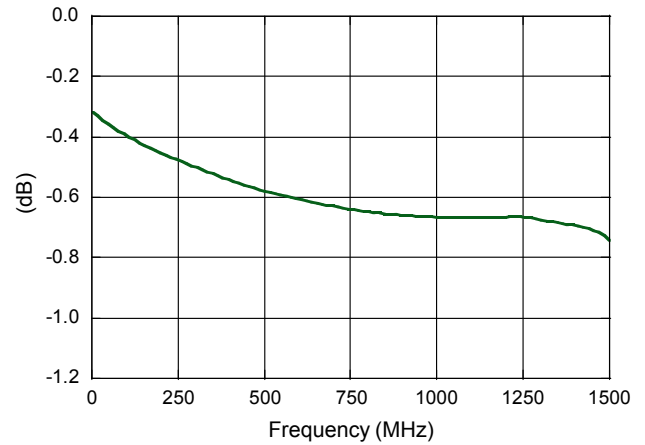

Amplitude Balance

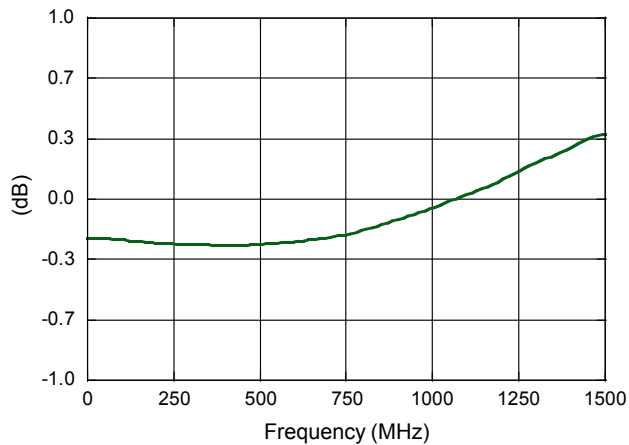

Phase Balance

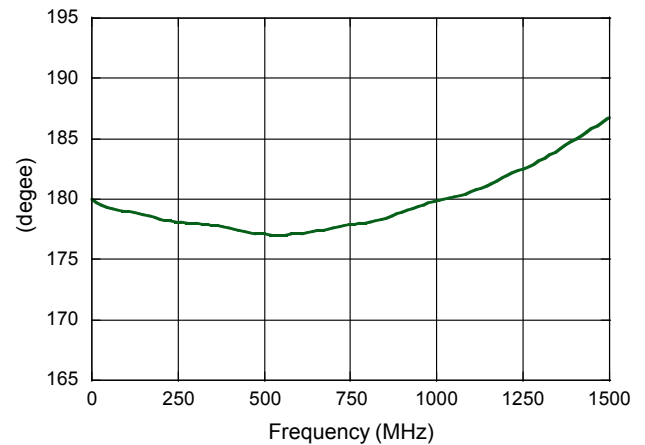

Input Return Loss (pin 1)

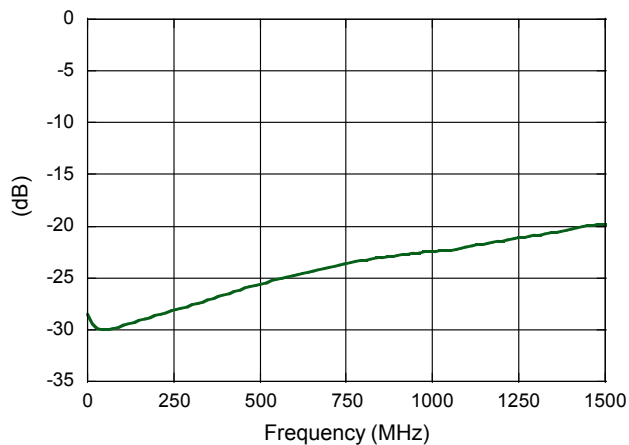

Balanced Output Return Loss

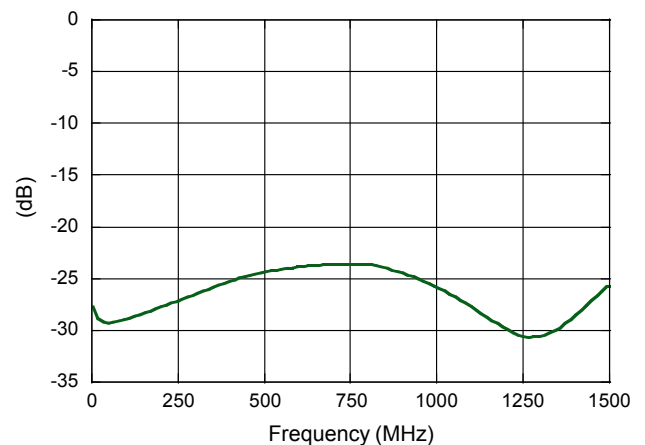

3 Full temperature plots available on request.

MACOM Technology Solutions Inc. (MACOM) and its affiliates reserve the right to make changes to the product(s) or information contained herein without notice. Visit www.macom.com for additional data sheets and product information.

For further information and support please visit:
<https://www.macom.com/support>

DC-0012064

1:1 Transmission Line Balun with Tertiary Winding 5 - 1225 MHz

Rev. V4

Part Outline Drawing^{9,10,11,12}

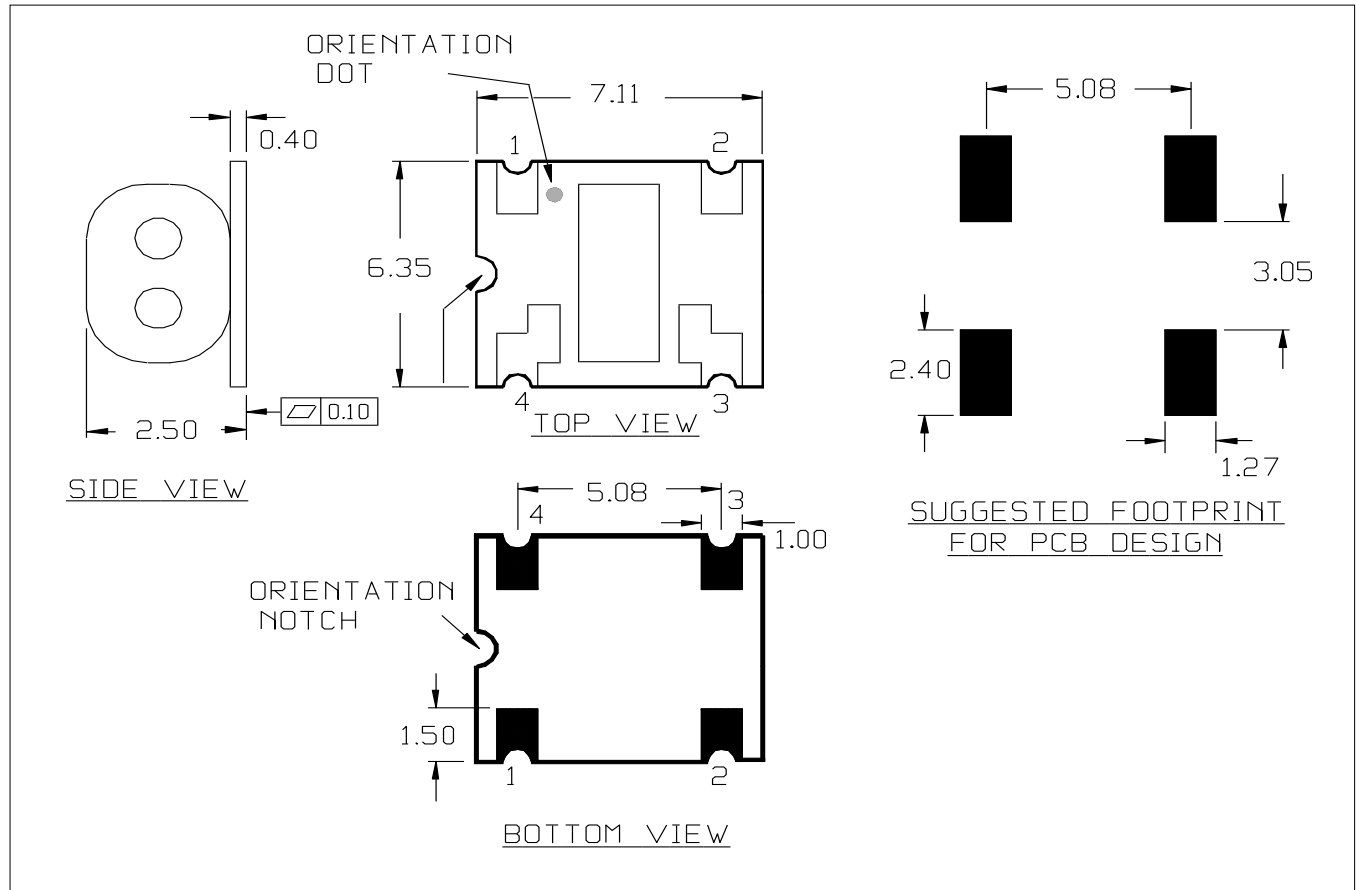

- 9. Dimensions in mm
- 10. Tolerance: ± 0.2 mm unless otherwise noted
- 11. Model number and lot code are printed on the reel
- 12. Plating finish: ENIG

Carrier Tape Orientation

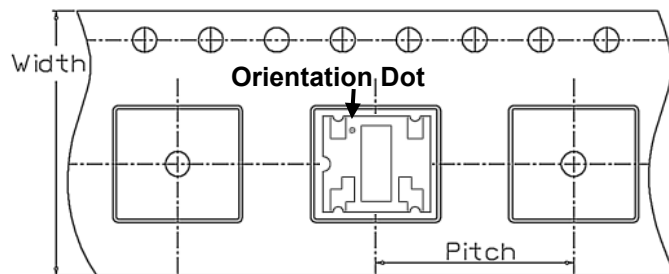

Tape & Reel Information

Parameter	Units	Value
Qty per reel	-	900
Reel Size	mm	330
Tape Width	mm	16.00
Pitch	mm	12.00
Orientation	-	F60
Reference Application Note ANI-019 for orientation		

MACOM Technology Solutions Inc. All rights reserved.

Information in this document is provided in connection with MACOM Technology Solutions Inc ("MACOM") products. These materials are provided by MACOM as a service to its customers and may be used for informational purposes only. Except as provided in MACOM's Terms and Conditions of Sale for such products or in any separate agreement related to this document, MACOM assumes no liability whatsoever. MACOM assumes no responsibility for errors or omissions in these materials. MACOM may make changes to specifications and product descriptions at any time, without notice. MACOM makes no commitment to update the information and shall have no responsibility whatsoever for conflicts or incompatibilities arising from future changes to its specifications and product descriptions. No license, express or implied, by estoppel or otherwise, to any intellectual property rights is granted by this document.

THESE MATERIALS ARE PROVIDED "AS IS" WITHOUT WARRANTY OF ANY KIND, EITHER EXPRESS OR IMPLIED, RELATING TO SALE AND/OR USE OF MACOM PRODUCTS INCLUDING LIABILITY OR WARRANTIES RELATING TO FITNESS FOR A PARTICULAR PURPOSE, CONSEQUENTIAL OR INCIDENTAL DAMAGES, MERCHANTABILITY, OR INFRINGEMENT OF ANY PATENT, COPYRIGHT OR OTHER INTELLECTUAL PROPERTY RIGHT. MACOM FURTHER DOES NOT WARRANT THE ACCURACY OR COMPLETENESS OF THE INFORMATION, TEXT, GRAPHICS OR OTHER ITEMS CONTAINED WITHIN THESE MATERIALS. MACOM SHALL NOT BE LIABLE FOR ANY SPECIAL, INDIRECT, INCIDENTAL, OR CONSEQUENTIAL DAMAGES, INCLUDING WITHOUT LIMITATION, LOST REVENUES OR LOST PROFITS, WHICH MAY RESULT FROM THE USE OF THESE MATERIALS.

MACOM products are not intended for use in medical, lifesaving or life sustaining applications. MACOM customers using or selling MACOM products for use in such applications do so at their own risk and agree to fully indemnify MACOM for any damages resulting from such improper use or sale.