



Test Procedure for the NCP59748MN1ADJTBGEVB Evaluation Board

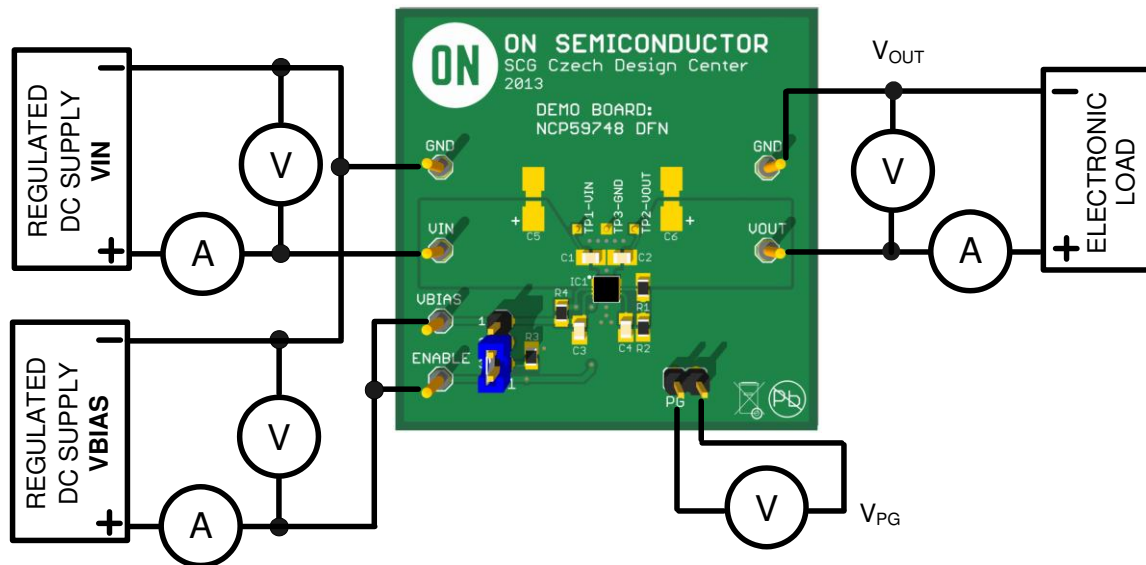

Figure 1: Test Setup

Test Procedure

1. Connect the test setup as shown in Figure 1.
2. Apply supply voltage $V_{in} = 1.5\text{ V}$
3. Apply supply voltage $V_{bias} = 5.0\text{ V}$
4. Apply $I_{out} = 10\text{ mA}$ load.
5. Check that V_{out} is 1.2 V
6. Increase I_{out} load current to 1.5 A
7. Check that V_{out} is 1.2 V
8. Decrease I_{out} load current to 10 mA
9. Check that voltage on PG output V_{PG} is 5 V
10. Decrease V_{in} voltage to 0.9 V
11. Check that voltage on PG output $V_{PG} < 0.1\text{ V}$
12. Power down the load
13. Power down V_{in} and V_{bias} supply
14. End of test