

2EA M.2 Module Datasheet (EAR00413/ EAR00448)

- Wi-Fi 6E, 802.11 a/b/g/n/ac/ax 2x2 MIMO
- Bluetooth 5.2 BR/EDR/LE
- PCIe interface, in M.2 form factor (22 x 44 mm)
- Chipset: Infineon/Cypress CYW55573

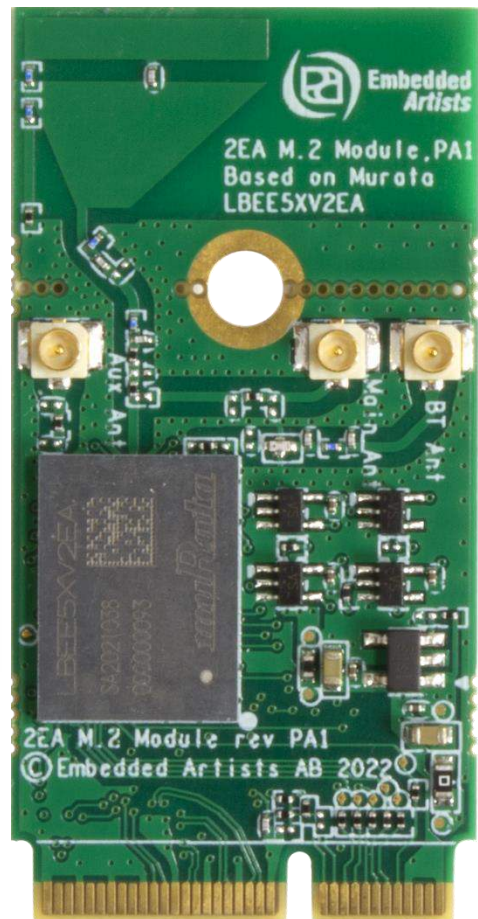

*Get Up-and-Running Quickly and
Start Developing Your Application on Day 1!*

Embedded Artists AB

Rundelsgatan 14
211 36 Malmö
Sweden

<https://www.EmbeddedArtists.com>

Copyright 2023 © Embedded Artists AB. All rights reserved.

No part of this publication may be reproduced, transmitted, transcribed, stored in a retrieval system, or translated into any language or computer language, in any form or by any means, electronic, mechanical, magnetic, optical, chemical, manual or otherwise, without the prior written permission of Embedded Artists AB.

Disclaimer

Embedded Artists AB makes no representation or warranties with respect to the contents hereof and specifically disclaim any implied warranties or merchantability or fitness for any particular purpose. The information has been carefully checked and is believed to be accurate, however, no responsibility is assumed for inaccuracies.

Information in this publication is subject to change without notice and does not represent a commitment on the part of Embedded Artists AB.

Feedback

We appreciate any feedback you may have for improvements on this document.

Trademarks

All brand and product names mentioned herein are trademarks, services marks, registered trademarks, or registered service marks of their respective owners and should be treated as such.

Table of Contents

1	Document Information	4
1.1	Revision History	4
2	Introduction	5
2.1	Benefits of Using an M.2 Module to get Wi-Fi/BT Connectivity	5
2.2	More M.2 Related Information	5
2.3	ESD Precaution and Handling	6
2.4	Product Compliance	6
3	Specification	7
3.1	Power Up Sequence	8
3.2	External Sleep Clock	8
3.3	Mechanical Dimensions	9
3.4	M.2 Pinning	11
3.5	SDIO Interface	15
3.6	Wi-Fi Interface Control	15
3.7	Test Points	16
3.8	Current Consumption Measurements	17
4	Antenna	18
4.1	Reference Certified External Antenna	18
4.2	Antenna Connector	19
4.3	Mounting and Clearance for On-board Antenna	19
4.4	Overriding on-board PCB Trace Antenna	20
4.5	On-board PCB Trace Antenna Performance	21
5	Software and Support	24
5.1	Software Driver	24
5.2	Support	24
6	Regulatory	25
6.1	European Union Regulatory Compliance	25
7	Disclaimers	26
7.1	Definition of Document Status	27

1 Document Information

This document applies to the following products.

<i>Product Name</i>	<i>Type Number</i>	<i>Murata Module</i>	<i>Chipset</i>	<i>Product Status</i>
2EA M.2 Module, rev PA1	EAR00413 / EAR00448	LBEE5XV2EA-SMP	CYW55573	Initial Production

This table below lists the product differences. All products are not stocked. Consult Embedded Artists for availability and lead time.

<i>Type Number</i>	<i>Product Name</i>	<i>Host Interface for Wi-Fi / Bluetooth functionality</i>	<i>Packaging</i>
EAR00413	2EA M.2 Module	PCIe / UART	Individual packing for evaluation.
EAR00448	2EA M.2 Module	PCIe / UART	Tray.

1.1 Revision History

<i>Revision</i>	<i>Date</i>	<i>Description</i>
PA1	2023-01-09	First version.
PA2	2023-05-11	Added information on different reference antennas.
PA3	2023-06-14	Corrected spelling error.

2 Introduction

This document is a datasheet that specifies and describes the *2EA M.2 module* mainly from a hardware point of view.

The main component in the design is Murata's 2EA module (full part number: LBEE5XV2EA-SMP). The 2EA M.2 module enables Wi-Fi, Bluetooth and Bluetooth Low Energy (LE) communication.

There are multiple application areas for the 2EA M.2 Module:

- Industrial and building automation
- Asset management
- IoT applications
- Smart home: Voice assist device, smart printer, smart speaker, home automation gateway, and IP camera
- Retail/POS
- Healthcare and medical devices
- Smart city

2.1 Benefits of Using an M.2 Module to get Wi-Fi/BT Connectivity

There are several benefits to use an *M.2 module* to add connectivity to an embedded design:

- Drop-in, certified solution!
- Modular and flexible approach to evaluate different Wi-Fi/BT solutions - with different trade-offs around performance, cost, power consumption, longevity, etc.
- Access to maintained software drivers (Linux and SDK) with responsive support from Murata.
- Supported by Embedded Artists' Developer's Kits for i.MX RT/6/7/8/9 development, including advanced debugging support on carrier boards
- One component to buy, instead of 40+
- No RF expertise is required
- Developed in close collaboration with Murata

2.2 More M.2 Related Information

For more information about the M.2 standard and Embedded Artists' adaptation, see: [M.2 Primer](#)

For more general information about the M.2 standard, see: <https://en.wikipedia.org/wiki/M.2>

The official M.2 specification (PCI Express M.2 Specification) is available from: www.pcisig.com

2.3 ESD Precaution and Handling

Please note that the M.2 module come without any case/box and all components are exposed for finger touches – and therefore extra attention must be paid to ESD (electrostatic discharge) precaution, for example use of static-free workstation and grounding strap. Only qualified personnel shall handle the product.



Make it a habit always to first touch the mounting hole (which is grounded) for a few seconds with both hands before touching any other parts of the boards. That way, you will have the same potential as the board and therefore minimize the risk for ESD.

In general, touch as little as possible on the boards to minimize the risk of ESD damage. The only reasons to touch the board are when mounting/unmounting it on a carrier board.

Note that Embedded Artists does not replace modules that have been damaged by ESD.

2.4 Product Compliance

Visit Embedded Artists' website at http://www.embeddedartists.com/product_compliance for up-to-date information about product compliances such as CE, RoHS2/3, Conflict Minerals, REACH, etc.

3 Specification

This chapter lists some of the more important characteristics of the M.2 module, but it is not a full specification of performance and timing. The main component in the design is Murata's 2EA module (full part number: LBEE5XV2EA-SMP), which in turn is based around Infineon's CYW55573 chipset.

For a full specification, see Murata's 2EA Module (LBEE5XV2EA) product page:

<https://www.murata.com/en-us/products/connectivitymodule/wi-fi-bluetooth/overview/lineup/type2ea> and the LBEE5XV2EA datasheet: <https://www.murata.com/products/productdata/TBD/type2ea.pdf>

Module / Chipset	
Murata module	LBEE5XV2EA-SMP
Chipset	Infineon CYW55573

Wi-Fi	
Standards	802.11a/b/g/n/ac/ax 2x2 MU-MIMO, Wi-Fi 6E
Network	uAP and STA dual mode
Frequency	2.4GHz, 5 GHz b and 6 GHz band
Data rates	11, 54, 144, 300, 867 Mbps
Host interface	PCIe (default) or SDIO 3.0 with rework (or on special order)

Bluetooth	
Standards	5.2 BR/EDR/LE, 2Mbps PHY
Power Class	Class 2
Host interface	4-wire UART@4MBaud
Audio interface	PCM for audio

Powering			
Supply voltage to M.2 module	Min	Typ	Max
	0.0V minimum 3.14V operating and RF specification	3.3V	3.5V
Note: Do not exceed minimum or maximum voltage. Module will be permanently damaged above this limit!			Note that LBEE5XV2EA module specification has higher maximum voltage (4.8V), but other components on the M.2 module limit the maximum voltage.
Peak current	TBD mA max		Note: The power supply must be designed for this peak current , which typically happen during the startup calibration process.
Receive mode current (WLAN, Concurrent dual-band receive)	TBD mA max		Note that current consumption varies widely between different operational modes.

Transmit mode current (WLAN, Concurrent dual-band transmit)	TBD mA max	Note that current consumption varies widely between different operational modes.
---	------------	--

Environmental Specification	
Operational Temperature	-40 to +85 degrees Celsius
Specification Temperature	-30 to +70 degrees Celsius
Storage Temperature	-40 to +85 degrees Celsius
Relative Humidity (RH), operating and storage	10 - 90% non-condensing

3.1 Power Up Sequence

The supply voltage shall not rise (10 - 90%) faster than 40 microseconds and not slower than 100 milliseconds.

Chipset signals WL_REG_ON (M.2 signal W_DISABLE1#) and BT_REG_ON (M.2 signal W_DISABLE2#) must be held low for at least 50 microseconds after supply voltage has reached specification level before pulled high. The 32.678kHz clock must also be active before any of the signals are pulled high. In addition to this, wait at least 150 ms after internal regulators and VDDIO are available before initiating PCIe accesses.

3.2 External Sleep Clock

The sleep clock signals can be applied to a powered and unpowered M.2 module (but have no effect when the M.2 module is unpowered).

Clock Specification	
Frequency	32.768 kHz
Frequency accuracy	±250 ppm including initial tolerance, aging, temperature, etc.
Duty cycle	30 - 70%
Clock jitter	10 000 ppm max (during initial start-up)
Voltage level	3.3V logic, according to M.2 standard

3.3 Mechanical Dimensions

The M.2 module is of type: 2230-D5-E according to the M.2 nomenclature. This means width 22 mm, length 30mm, top and bottom side component height 1.5 mm and key-E connector. The table below lists the different dimensions and weight.

M.2 Module Dimension	Value (± 0.15 mm)	Unit
Width	22	mm
Height, with pcb trace antenna	44	mm
Height, without pcb trace antenna	30	mm
PCB thickness	0.8	mm
Maximum component height on top side	1.5	mm
Maximum component height on bottom side	1.5	mm
Ground hole diameter	3.5	mm
Plating around ground hole, diameter	5.5	mm
Module weight	1.5 \pm 0.5 gram	gram

Embedded Artists has added a non-standard feature to the 2230 M.2 modules designed together with Murata, NXP and Infineon (former Cypress). The pictures below illustrate how the standard module size has been extended by 14 mm in the length direction to include a pcb trace antenna.

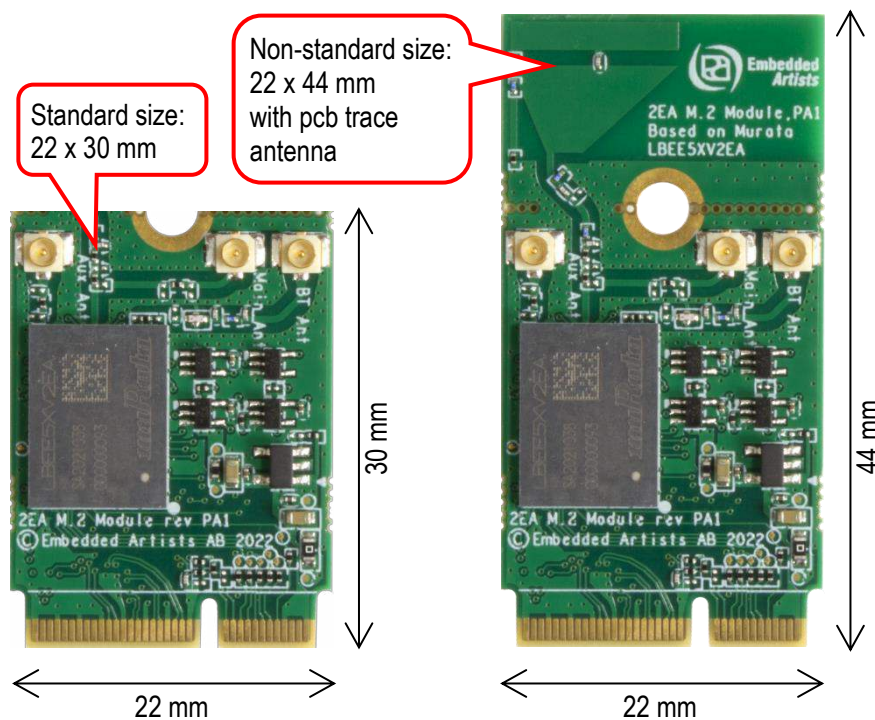

Figure 1 – M.2 Module with, and without, PCB Trace Antenna

The picture below gives dimensions for the grounded center (half) hole and the u.fl. antenna connector.

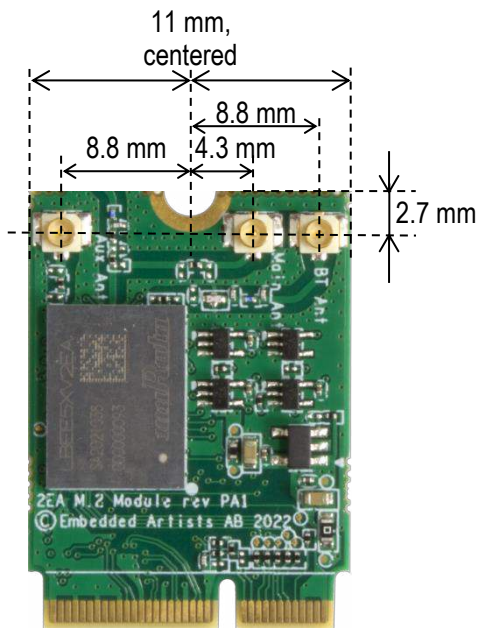

Figure 2 – M.2 Module Without Trace Antenna

3.4 M.2 Pinning

This section presents the pinning used for the M.2 module. It is essentially M.2 Key-E compliant with enhancements to support additional debug signals and 3.3V VDDIO override. The pin assignment for specific control and debug signals has been jointly defined by Embedded Artists, Murata, NXP and Infineon (former Cypress).

The picture below illustrates the edge pin numbering. It starts on the right edge and alternates between top and bottom side. The removed pads in the keying notch count (but are obviously non-existing).

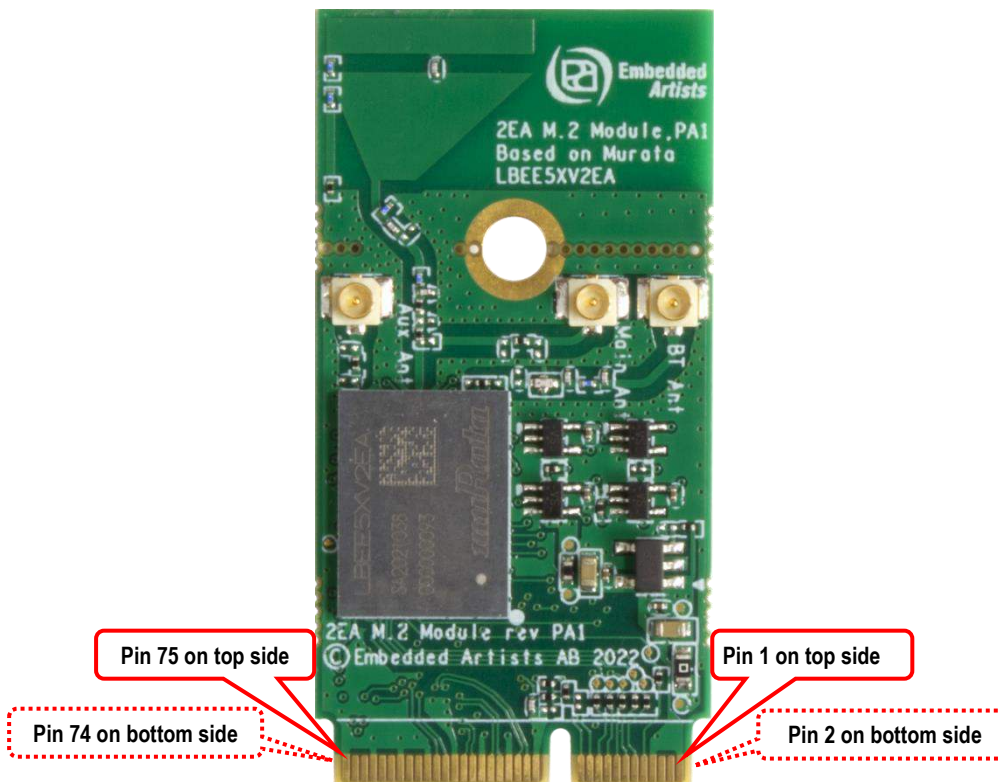

Figure 3 – M.2 Module Pin Numbering

The Wi-Fi interface uses the PCIe interface as default, but it is possible to configure the module to use the SDIO interface instead, see section 3.6 for details. The Bluetooth interface uses the UART interface for control and PCM interface for audio. The table below lists the pin usage for the 2EA M.2 module. The column "When is signal needed" signals four different categories:

- Always: These signals shall always be connected.
- Wi-Fi PCIe: These signals shall always be connected when the PCIe interface is used for Wi-Fi.
- Wi-Fi SDIO: These signals shall always be connected when the SDIO interface is used for Wi-Fi.
- Bluetooth: These signals shall always be connected when the Bluetooth interface is used.
- Optional: These signals are optional to connect.

Pin #	Side of pcb	M.2 Name	Voltage Level and Signal Direction	When is signal needed	Note
-------	-------------	----------	------------------------------------	-----------------------	------

1	Top	GND	GND	Always	Connect to ground
2	Bottom	3.3 V		Always	Power supply input. Connect to stable, low-noise 3.3V supply.
3	Top	USB_D+			Not connected.
4	Bottom	3.3 V		Always	Power supply input. Connect to stable, low-noise 3.3V supply.
5	Top	USB_D-			Not connected.
6	Bottom	LED_1#			Not connected.
7	Top	GND	GND	Always	Connect to ground.
8	Bottom	PCM_CLK	1.8V I/O	Bluetooth audio	For Bluetooth audio interface: BT_PCM_CLK Connected to 2EA module, signal BT_PCM_CLK, pin 7
9	Top	SDIO_CLK	1.8V Input to M.2	Wi-Fi SDIO	For Wi-Fi SDIO interface: SDIO_CLK Connected to 2EA module, signal SDIO_CLK, pin 65
10	Bottom	PCM_SYNC	1.8V I/O	Bluetooth audio	For Bluetooth audio interface: BT_PCM_SYNC Connected to 2EA module, signal BT_PCM_SYNC, pin 5
11	Top	SDIO_CMD	1.8V I/O	Wi-Fi SDIO	For Wi-Fi SDIO interface: SDIO_CMD Connected to 2EA module, signal SDIO_CMD, pin 64 Note: Require an external 10-100K ohm pullup
12	Bottom	PCM_OUT	1.8V output from M.2	Bluetooth audio	For Bluetooth audio interface: BT_PCM_OUT Connected to 2EA module, signal BT_PCM_OUT, pin 8
13	Top	SDIO_DATA0	1.8V I/O	Wi-Fi SDIO	For Wi-Fi SDIO interface: SDIO_D0 Connected to 2EA module, signal SDIO_DATA_0, pin 62 Note: Require an external 10-100K ohm pullup
14	Bottom	PCM_IN	1.8V input to M.2	Bluetooth audio	For Bluetooth audio interface: BT_PCM_IN Connected to 2EA module, signal BT_PCM_IN, pin 6
15	Top	SDIO_DATA1	1.8V I/O	Wi-Fi SDIO	For Wi-Fi SDIO interface: SDIO_D1 Connected to 2EA module, signal SDIO_DATA_1, pin 63 Note: Require an external 10-100K ohm pullup
16	Bottom	LED_2#			Not connected.
17	Top	SDIO_DATA2	1.8V I/O	Wi-Fi SDIO	For Wi-Fi SDIO interface: SDIO_D2 Connected to 2EA module, signal SDIO_DATA_2, pin 61 Note: Require an external 10-100K ohm pullup
18	Bottom	GND		Always	Connect to ground.
19	Top	SDIO_DATA3	1.8V I/O	Wi-Fi SDIO	For Wi-Fi SDIO interface: SDIO_D3 Connected to 2EA module, signal SDIO_DATA_3, pin 66 Note: Require an external 10-100K ohm pullup
20	Bottom	UART_WAKE#	3.3V output from M.2	Bluetooth	For Bluetooth UART interface: BT_HOST_WAKE_L This is a wake signal for the Bluetooth interface from the device (Wi-Fi/BT chipset) to the host (CPU). Connected to 2EA module, via buffer, signal BT_HOST_WAKE, pin 27
21	Top	SDIO_WAKE#	1.8V output from M.2	Wi-Fi SDIO	For Wi-Fi SDIO interface WL_HOST_WAKE_L This is a wake signal for the Wi-Fi interface from the device (Wi-Fi/BT chipset) to the host (CPU). Connected to 2EA module, via buffer, signal GPIO_0, pin 43
22	Bottom	UART_TXD	1.8V output from M.2	Bluetooth	For Bluetooth UART interface: BT_UART_TXD Connected to 2EA module, signal BT_UART_TXD, pin 18

23	Top	SDIO RESET#			Not connected. The Wi-Fi SDIO interface is controlled by pin 56, W_DISABLE1#, which is a 3.3V logic level signal.
24-31	Key, non-existing				
32	Bottom	UART_RXD	1.8V input to M.2	Bluetooth	For Bluetooth UART interface: BT_UART_RXD Connected to 2EA module, signal BT_UART_RXD, pin 16
33	Top	GND		Always	Connect to ground.
34	Bottom	UART_RTS	1.8V output from M.2	Bluetooth	For Bluetooth UART interface: BT_UART_RTS Connected to 2EA module, signal BT_UART_RTS_N, pin 17
35	Top	PERp0	PCIe input to M.2	Wi-Fi PCIe	PCIe data input (receive, positive signal) Connected to 2EA module, signal PCIE_RDP, pin 68
36	Bottom	UART_CTS	1.8V input to M.2	Bluetooth	For Bluetooth UART interface: BT_UART_CTS Connected to 2EA module, signal BT_UART_CTS_N, pin 19
37	Top	PERn0	PCIe input to M.2	Wi-Fi PCIe	PCIe data input (receive, negative signal) Connected to 2EA module, signal PCIE_RDN, pin 69
38	Bottom	VENDOR DEFINED			Not connected.
39	Top	GND		Always	Connect to ground.
40	Bottom	VENDOR DEFINED	1.8V I/O	Wi-Fi SDIO	For Wi-Fi SDIO interface WL_DEV_WAKE_L This is a wake signal for the Wi-Fi interface from the host (CPU) to the device (Wi-Fi/BT chipset). Connected to 2EA module, signal LHL_GPIO1, pin 32
41	Top	PETp0	PCIe output from M.2	Wi-Fi PCIe	PCIe data output (transmit, positive signal) Connected to 2EA module, via 100nF capacitor, signal PCIE_TDP, pin 71
42	Bottom	VENDOR DEFINED	1.8V input to M.2 ⁽¹⁾	Bluetooth	For Bluetooth UART interface: BT_DEV_WAKE_L This is a wake signal for the Bluetooth interface from the host (CPU) to the device (Wi-Fi/BT chipset). Connected to 2EA module, signal BT_DEV_WAKE, pin 26
43	Top	PETn0	PCIe output from M.2	Wi-Fi PCIe	PCIe data output (transmit, negative signal) Connected to 2EA module, via 100nF capacitor, signal PCIE_TDN, pin 72
44	Bottom	COEX3			Not connected.
45	Top	GND		Always	Connect to ground.
46	Bottom	COEX_TXD			Not connected.
47	Top	REFCLKp0	PCIe clock input to M.2	Wi-Fi PCIe	PCIe clock input (receive, positive signal) Connected to 2EA module, signal PCIE_REFCLKP, pin 74
48	Bottom	COEX_RXD			Not connected.
49	Top	REFCLKn0	PCIe clock input to M.2	Wi-Fi PCIe	PCIe clock input (receive, negative signal) Connected to 2EA module, signal PCIE_REFCLKN, pin 75
50	Bottom	SUSCLK			External sleep clock input (32.768kHz) Connected to 2EA module, via buffer, signal LPO_IN, pin 51
51	Top	GND		Always	Connect to ground.
52	Bottom	PERST0#	3.3V input to M.2	Wi-Fi PCIe	PCIe PERST# signal, used to initialize the M.2 functions once power sources stabilize. Connected to 2EA module, via voltage translator, signal PCIE_PERST_L, pin 1

53	Top	CLKREQ0#	3.3V OD output from M.2	Wi-Fi PCIe	PCIe clock request (low level request reference clock) Connected to 2EA module, via open drain buffer, signal PCIE_CLKREQ_N, pin 2 Note: Requires external 10Kohm pull-up
54	Bottom	W_DISABLE2#	3.3V input to M.2	Always	Connected to 2EA module, via buffer, signal BTREG_ON, pin 45 High = Bluetooth funct. enabled/internally powered, Low = Bluetooth funct. disabled/powered down
55	Top	PEWAKE0#	3.3V OD output from M.2	Wi-Fi PCIe	PCIe wake request (low level request host wakeup) Connected to 2EA module, via open drain buffer, signal PCIE_PME_L, pin 3 Note: Requires external 10Kohm pull-up
56	Bottom	W_DISABLE1#	3.3V input to M.2	Always	Connected to 2EA module, via buffer, signal WLREG_ON, pin 60 High = Wi-Fi funct. enabled/internally powered, Low = Wi-Fi funct. disabled/powered down
57	Top	GND		Always	Connect to ground.
58	Bottom	I2C_SDA			Not connected.
59	Top	Reserved			Not connected.
60	Bottom	I2C_CLK			Not connected.
61	Top	Reserved			Not connected.
62	Bottom	ALERT#			Not connected.
63	Top	GND		Always	Connect to ground.
64	Bottom	RESERVED			Not connected.
65	Top	Reserved			Not connected.
66	Bottom	UIM_SWP			Not connected.
67	Top	Reserved			Not connected.
68	Bottom	UIM_POWER_SNK			Not connected.
69	Top	GND		Always	Connect to ground.
70	Bottom	UIM_POWER_SRC/GPIO_1			Not connected.
71	Top	Reserved			Not connected.
72	Bottom	3.3 V		Always	Power supply input. Connect to stable, low-noise 3.3V supply.
73	Top	Reserved			Not connected.
74	Bottom	3.3 V		Always	Power supply input. Connect to stable, low-noise 3.3V supply.
75	Top	GND		Always	Connect to ground.

3.5 SDIO Interface

The SDIO interface conforms to the SDIO v3.0 specification, including the UHS-I modes, and is backward compatible with SDIO v2.0.

Note: The SDIO interface is not enabled by default. It requires a manual rework of the hardware to be enabled (can be ordered as a special mounting option). Software drivers must also be updated to support the SDIO interface.

SDIO bus speed modes	Max SDIO clock frequency	Max bus speed	Signaling voltage according to M.2 specification
DS (Default speed)	25 MHz	12.5 MByte/s	1.8 V
HS (High speed)	50 MHz	25 MByte/s	1.8 V
SDR12	25 MHz	12.5 MByte/s	1.8 V
SDR25	50 MHz	25 MByte/s	1.8 V
SDR50	100 MHz	50 MByte/s	1.8 V
SDR104	208 MHz	104 MByte/s	1.8 V

3.6 Wi-Fi Interface Control

The **default interface** for Wi-Fi is **PCIe**. It is possible to change this to the SDIO interface with a small rework, as described in the picture below.

Note that there is no publicly available driver that supports the SDIO interface. It is currently only available for specific customers.

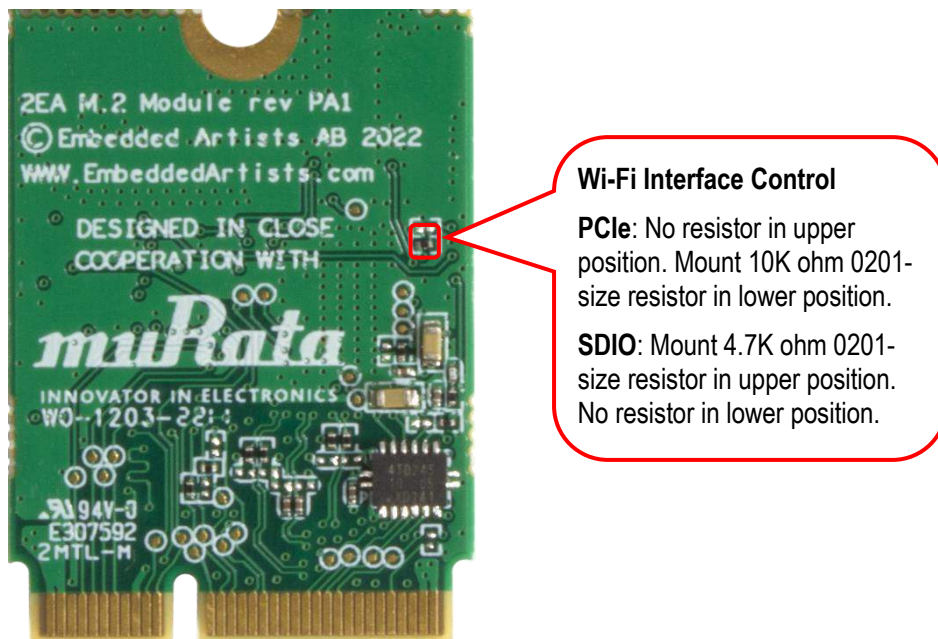

Figure 4 – 2EA M.2 Module Wi-Fi Interface Control

3.7 Test Points

There are some test points that can be of interest to probe for debugging purposes, as illustrated in the picture below.

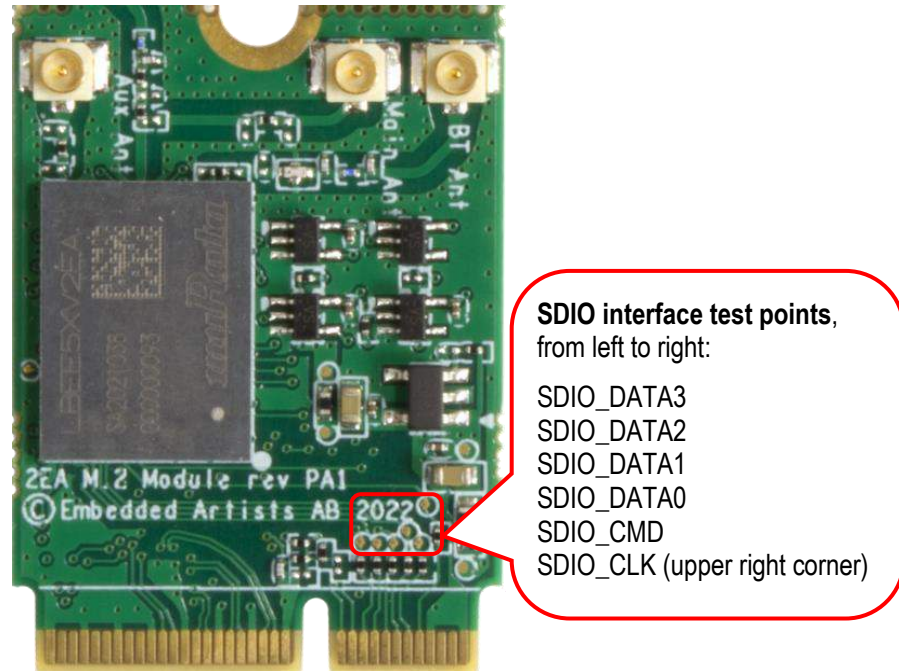

Figure 5 – 2EA M.2 Module Top Side Test Points

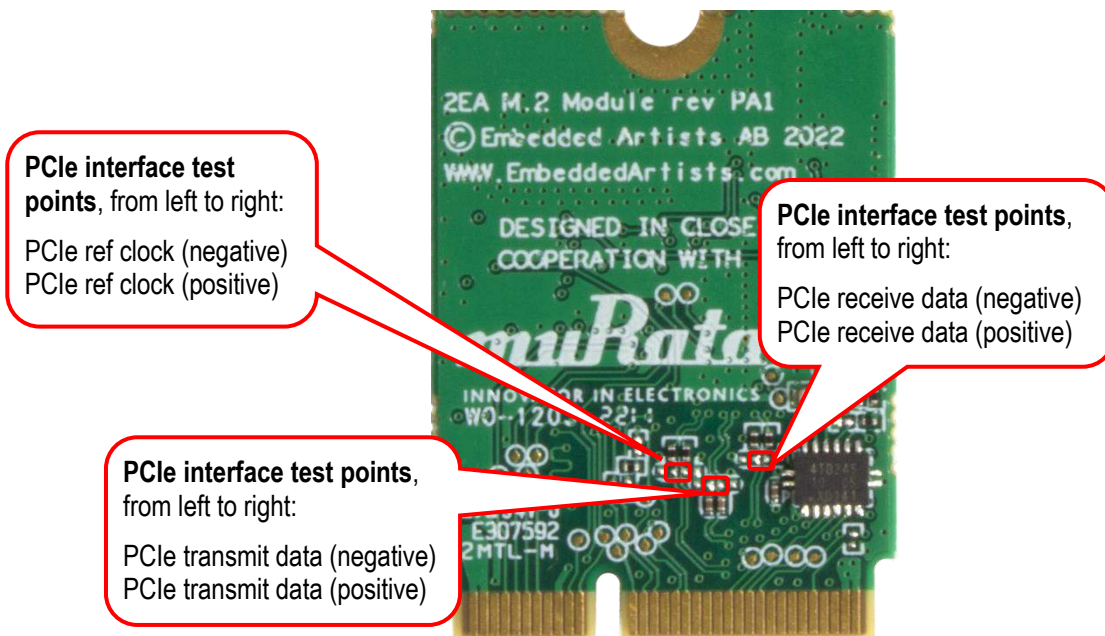

Figure 6 – 2EA M.2 Module Bottom Side Test Points

3.8 Current Consumption Measurements

It is possible to measure the currents of the power supplies to the 2EA module, VBAT and VDDIO. VBAT is the 3.3V that is supplied to the M.2 interface and VDDIO is an on-board generated 1.8V. VDDIO is generated from the supplied 3.3V. Note that when measuring the VBAT current, the VDDIO current will be included in this measurement. The VDDIO current can however be measured independently.

Note that zero ohm resistors are mounted by default. Select a series resistor with as low resistance as possible to keep the voltage drop to a minimum. Keep the drop below 100mV. VBAT can be above 1 Amp in peak which means that maximum series resistance is 100 milliOhm for the VBAT resistor. For VDDIO the current is lower so a 1 ohm resistor can be a suitable value.

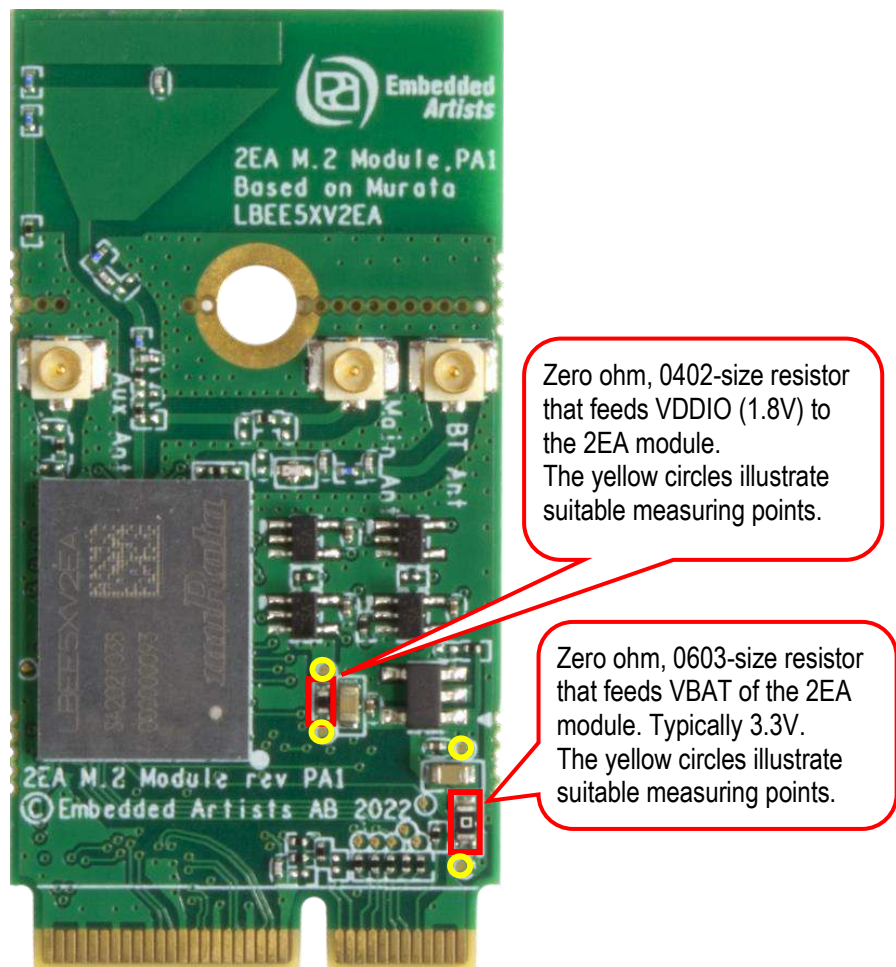

Figure 7 – Current Measurement

4 Antenna

This chapter addresses the antenna side of the module. There is an on-board, reference certified pcb trace antenna for 1x1 SISO operation. This can be used for testing/evaluation purposes, but also for the final product. Also, for testing and evaluation purposes, it is possible to disconnect the on-board antenna and instead use the u.fl. connectors to connect external antennas.

It is not possible to have two on-board antennas for 2x2 MIMO operation because the M.2 module is too small to get spatial separation of the two antennas. Two external antennas must be connected to support 2x2 MIMO operation.

4.1 Reference Certified External Antenna

There are multiple reference certified antennas to choose from, see table below. Note that there are different antennas depending on if the 2EA module operates in SISO or MIMO mode.

Mode of Operation	Antenna type	Supplier	Antenna Part Number	Frequency (MHz)	Peak Antenna Gain (dBi)
SISO operation	Monopole	Murata	On-board	5925-7125	2.5
SISO operation	Dipole	Molex	146153	5925-7125	5.8
SISO or MIMO operation	Dipole	Molex	219611	5925-7125	4
SISO or MIMO operation	Dipole	Unictron	WT32D1-KX	5925-7125	4

Both Molex 1461530050 and 2196110050 are balanced, dipole-type, high efficiency antennas used for the reference certification of the Murata 2EA module (note that 1461530050 is only certified for SISO operation). These are ground plane independent, tripple band antennas that support the 2400-2500MHz, 5150-5850MHz, 5925-7125MHz frequency bands. They are physically small (41 x 9 x 0.7mm and 35.4 x 15.4 x 0.23mm, respectively). The antenna cables come in 6 standard length options: 50/100/150/200/250/300mm (50mm is used for the reference certification) and the connector is MHF-I, which is a U.FL compatible connector.



Figure 8 – Reference Certified Antenna

Note that no antennas are included when ordering the evaluation bundle of the 2EA M.2 board. The on-board antenna is used for the default SISO operation.

4.2 Antenna Connector

The M.2 standard specifies a 1.5 mm outer ring diameter male connector, which is compatible with the Murata MSC and IPEX MHF4 connector specifications. This connector is not used since our M.2 modules also target industrial users, where the Hirose U.FL. connector standard is more commonly used. U.FL. is compatible with the IPEX MHF1 connector specification.

4.3 Mounting and Clearance for On-board Antenna

Ideally, arrange the M.2 module so that the antenna is located at a corner of the product. Keep plastic case (i.e., non-metallic) away from the antenna area with at least 5 mm clearance (in all directions). Also keep any metal elements (e.g., connectors, battery, etc.) away from the antenna area with at least 5 mm clearance (in all directions). Keep a clearance area under and above the antenna area of at least 7.5mm, both under and over the PCB.

Human hands or body parts should be kept away (in the normal use case) from the antenna area.

The ground hole in the middle shall be grounded. Use a metal stand-off according to M.2 standard (height suitable for selected M.2 connector) and use metal screw to create a proper ground connection.

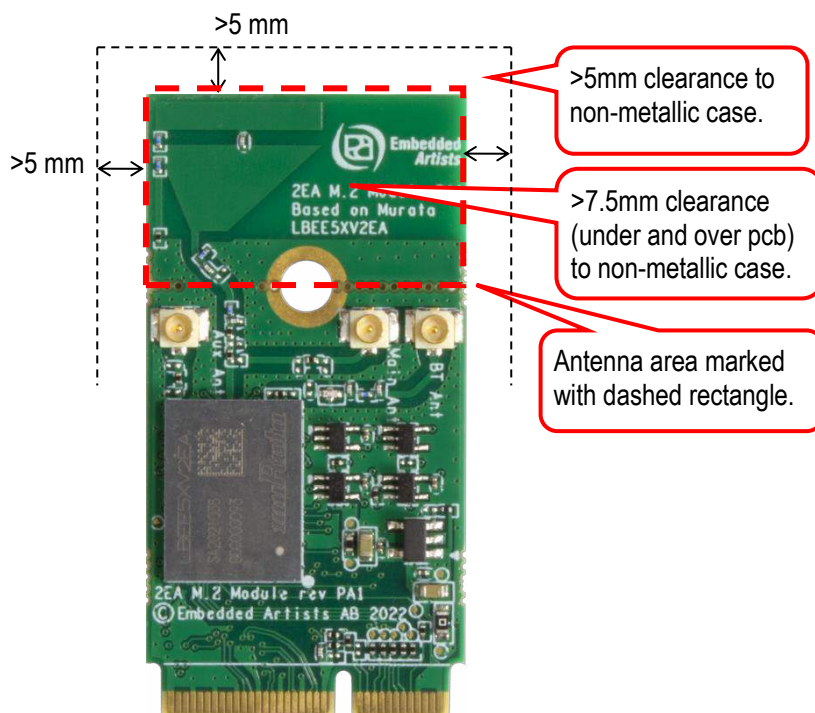

Figure 9 – M.2 Module Clearance Area

4.4 Overriding on-board PCB Trace Antenna

Per default, the on-board PCB trace antenna is used for the Wi-Fi and Bluetooth interface. The antenna connection from the 2EA module can be redirected to the U.FL. connector by just moving one zero ohm 0201 series resistor, see illustration below. The on-board trace antenna can be left as-is, or the antenna part can be snapped-off.

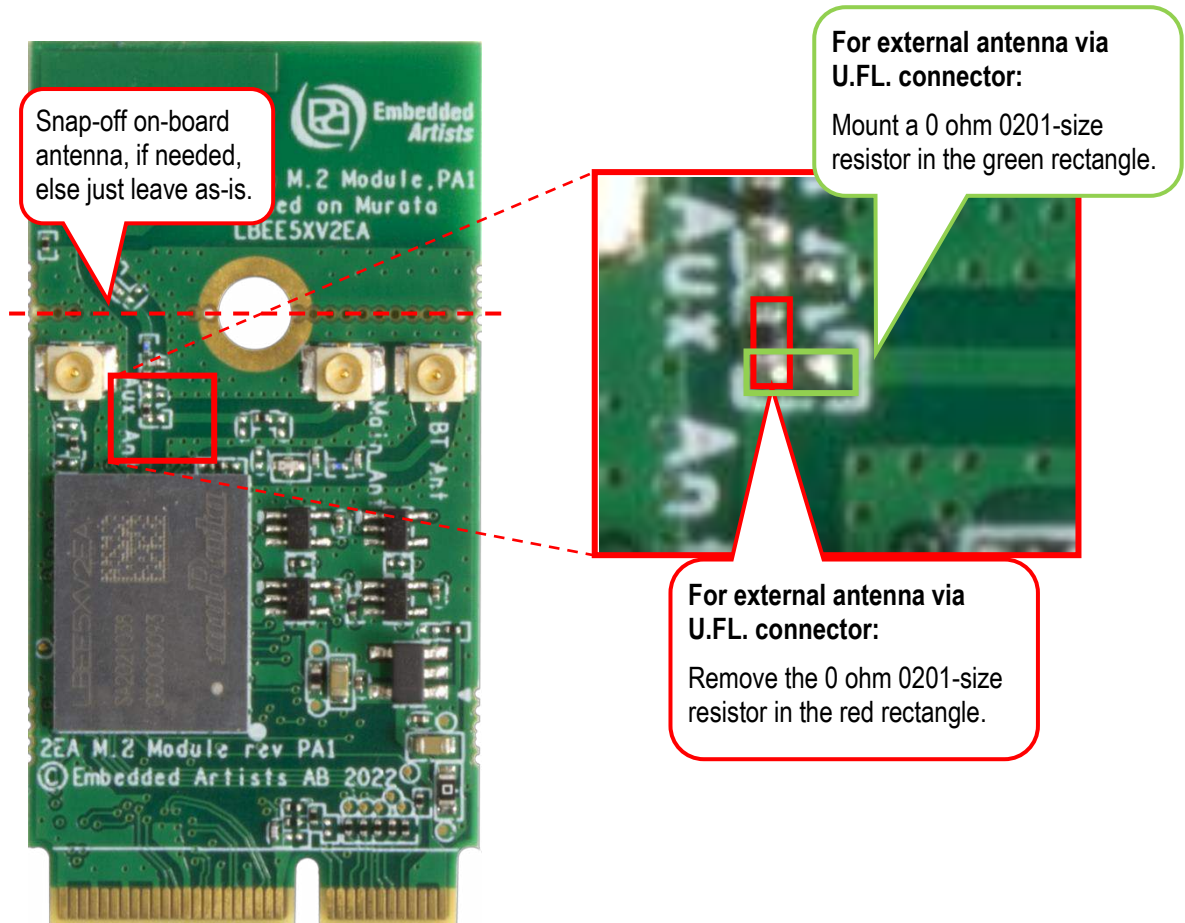

Figure 10 – Rework to Connect U.FL. Connector

After the rework, the three antenna connectors are located as illustrated below.

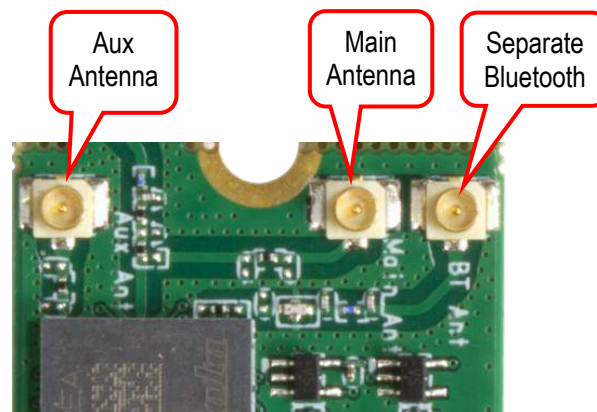

Figure 11 – 2EA M.2 Module Antenna Connectors

4.5 On-board PCB Trace Antenna Performance

The on-board pcb trace antenna type is monopole, certified by Murata.

The table below lists total efficiency:

Measurement condition	Frequency MHz						Total Efficiency in dB		Total Efficiency in %	
	2400	2442	2484	5150	5500	5850	Average 2 GHz band	Average 5 GHz band	Average 2 GHz band	Average 5 GHz band
Certified trace antenna	-1.0	-1.0	-0.9	-1.3	-1.6	-1.5	-1.0	-1.5	80.1	71.5

The table below lists peak gain:

Measurement condition	Frequency MHz						Max dBi	
	2400	2442	2484	5150	5500	5850	Max 2 GHz band	Max 5 GHz band
Certified trace antenna	2.6	2.4	2.5	3.5	3.6	3.5	2.6	3.64

The pictures below illustrate the return loss and efficiency.

<Return Loss>

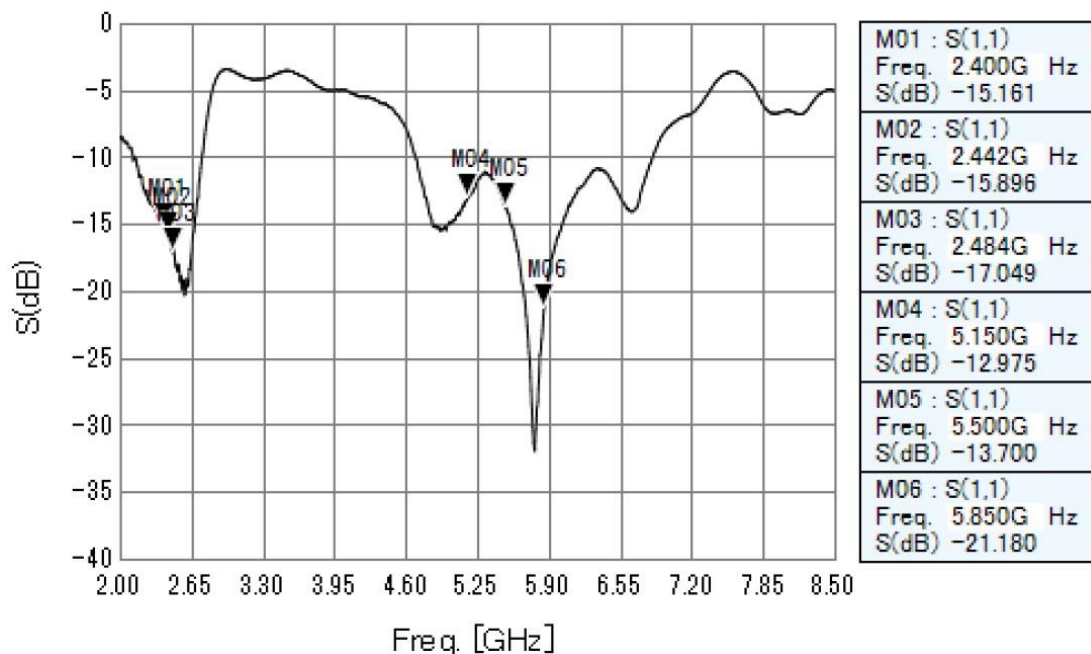

Figure 12 – Return Loss for Certified Trace Antenna

<Efficiency>

LINEAR POLARIZATION		XY-plane		YZ-plane		ZX-plane		Total Efficiency
		hor.	ver.	hor.	ver.	hor.	ver.	
2400 MHz	MAX.	-1.6	-0.9	2.6	-16.3	-2.2	1.0	-1.0
	AVE.	-4.9	-4.6	-2.0	-20.4	-8.3	-0.9	
2442 MHz	MAX.	-1.6	-0.8	2.4	-15.0	-2.0	1.1	-1.0
	AVE.	-5.1	-4.6	-1.9	-19.5	-8.3	-0.7	
2484 MHz	MAX.	-1.7	-0.7	2.5	-13.6	-1.7	1.6	-0.9
	AVE.	-5.2	-4.5	-1.6	-18.7	-8.2	-0.5	

LINEAR POLARIZATION		XY-plane		YZ-plane		ZX-plane		Total Efficiency
		hor.	ver.	hor.	ver.	hor.	ver.	
5150 MHz	MAX.	2.3	0.1	2.2	-11.4	3.5	-0.2	-1.3
	AVE.	-4.1	-4.5	-2.0	-19.2	-3.9	-3.9	
5500 MHz	MAX.	2.3	-0.6	1.0	-12.7	3.6	-1.8	-1.6
	AVE.	-4.3	-5.0	-2.4	-20.0	-4.3	-5.1	
5850 MHz	MAX.	2.3	-0.7	1.0	-12.9	3.5	-1.6	-1.5
	AVE.	-4.1	-5.4	-2.4	-19.8	-4.2	-5.5	

Figure 13 – Efficiency for Certified Trace Antenna

The directivity measurements are presented below for the 2 GHz and 5GHz bands with the orientation as illustrated below.

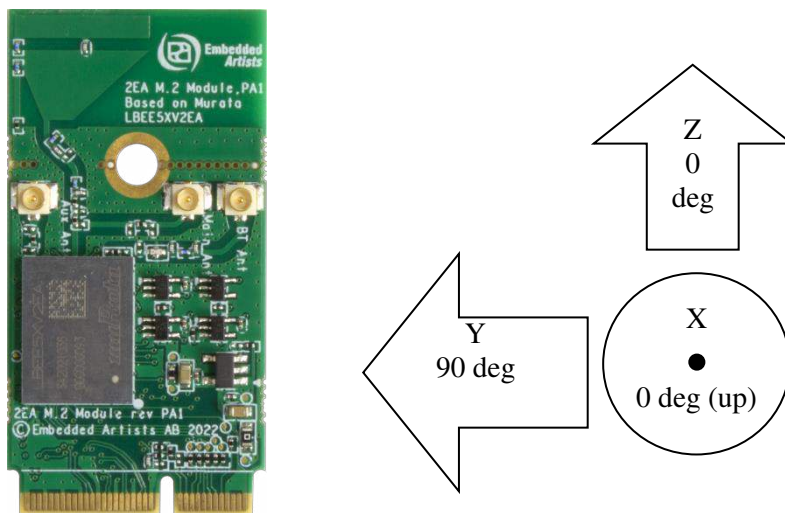
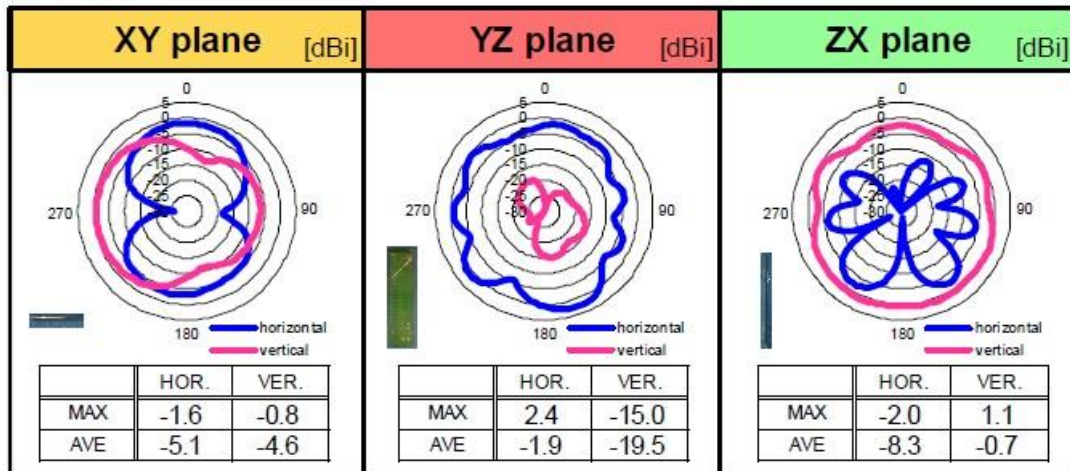

Figure 14 –Plane Orientations

<Directivity>

@2442MHz



@5500MHz

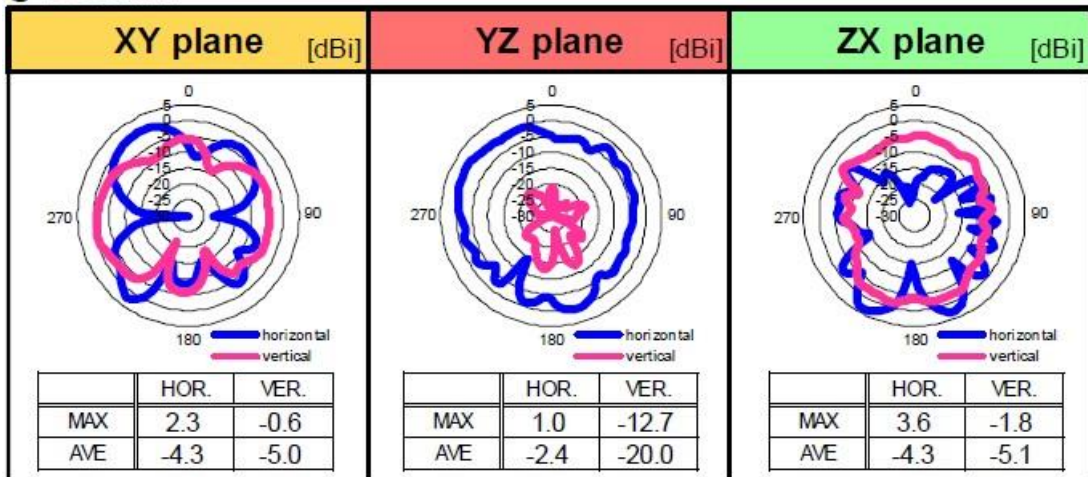

Figure 15 – Directivity for Certified Trace Antenna

5 Software and Support

This chapter contains information about software and support.

5.1 Software Driver

The CYW 55573 chipset does not contain any persistent software. A firmware image must be downloaded by the host at start-up. This is the responsibility of the operating system driver.

There are three different cases, depending on which host processor is used:

1. **Embedded Artists' Computer-on-Modules, (u)COM, as host processor**

Embedded Artists' Linux BSPs and SDKs for the different (u)COM board contains all drivers available and pre-configured. Everything has been tested and works out-of-the-box on our many iMX Developer's Kits.

iMX Developer's Kit	2EA M.2 PCIe support	2EA M.2 SDIO support
iMX93 uCOM	Not yet released	Not yet released
iMX8M Mini uCOM	Linux v5.10.72	TBD
iMX8M Nano uCOM	No	No
iMX7 Dual COM	Linux v5.10.72	TBD
iMX7 Dual uCOM	Linux v5.10.72	TBD
iMX7ULP uCOM	No	No
iMX6 Quad COM	Linux v5.10.72	TBD
iMX6 DualLite COM	Linux v5.10.72	TBD
iMX6 SoloX COM	Linux v5.10.72	TBD
iMX6 UltraLite/ULL COM	No	No
iMX RT1176 uCOM	No	No
iMX RT1166 uCOM	No	No
iMX RT1064 uCOM	No	No
iMX RT1062 OEM	No	No

2. **Other i.MX based, for example NXP's EVKs**

Murata has created documentation how to compile the Linux kernel for the NXP EVKs
<https://wireless.murata.com/products/rf-modules-1/wi-fi-bluetooth-for-nxp-i-mx.html#Linux>

3. **Non-i.MX host processor**

There is no ready-to-go driver exist. Contact Murata to check driver availability on the hardware platform used.

5.2 Support

Embedded Artists supports customers that use our M.2 module in combination with Embedded Artists' Computer-on-Modules, (u)COM, based on NXP's i.MX RT/6/7/8/9 families.

For other platforms, support is provided by Murata via their Community Support Forum:
<https://community.murata.com/s/topic/0TO5F0000002TLWWA2/connectivity-modules>

6 Regulatory

The Murata 2EA module is reference certified. See the LBEE5XV2EA datasheet from Murata for details.

6.1 European Union Regulatory Compliance

EUROPEAN DECLARATION OF CONFORMITY (Simplified DoC per Article 10.9 of the Radio Equipment Directive 2014/53/EU)

This apparatus, namely 2EA M.2 module (pn EAR00413 / EAR00448) conforms to the Radio Equipment Directive (RED) 2014/53/EU. The full EU Declaration of Conformity for this apparatus can be found at this location: <https://www.embeddedartists.com/products/2ea-m-2-module/>, see documents *2EA M.2 module Declaration of Conformity*.

The following information is provided per Article 10.8 of the Radio Equipment Directive 2014/53/EU:

(a) Frequency bands in which the equipment operates.

(b) The maximum RF power transmitted.

PN	RF Technology	(a) Frequency Ranges (EU)	(b) Max Transmitted Power
EAR00413 / EAR00448	Bluetooth BR/EDR/LE	2400 MHz – 2484 MHz	6 dBm
EAR00413 / EAR00448	Wi-Fi IEEE 802.11b/g/n	2400 MHz – 2484 MHz	20 dBm
EAR00413 / EAR00448	Wi-Fi IEEE 802.11a/n/ac/ax	5150 MHz – 5850 MHz	19 dBm
EAR00413 / EAR00448	Wi-Fi IEEE 802.11ax	5985 MHz – 7025 MHz	TBD dBm

The 2EA M.2 module complies with the Directive 2011/65/EU (EU RoHS 2) and its amendment Directive (EU) 2015/863 (EU RoHS 3).

7 Disclaimers

Embedded Artists reserves the right to make changes to information published in this document, including, without limitation, specifications and product descriptions, at any time and without notice. This document supersedes and replaces all information supplied prior to the publication hereof.

Customer is responsible for the design and operation of their applications and products using Embedded Artists' products, and Embedded Artists accepts no liability for any assistance with applications or customer product design. It is customer's sole responsibility to determine whether the Embedded Artists' product is suitable and fit for the customer's applications and products planned, as well as for the planned application and use of customer's third party customer(s). Customers should provide appropriate design and operating safeguards to minimize the risks associated with their applications and products. Customer is required to have expertise in electrical engineering and computer engineering for the installation and use of Embedded Artists' products.

Embedded Artists does not accept any liability related to any default, damage, costs or problem which is based on any weakness or default in the customer's applications or products, or the application or use by customer's third party customer(s). Customer is responsible for doing all necessary testing for the customer's applications and products using Embedded Artists' products in order to avoid a default of the applications and the products or of the application or use by customer's third party customer(s). Embedded Artists does not accept any liability in this respect.

Embedded Artists does not accept any liability for errata on individual components. Customer is responsible to make sure all errata published by the manufacturer of each component are taken note of. The manufacturer's advice should be followed.

Embedded Artists does not accept any liability and no warranty is given for any unexpected software behavior due to deficient components.

Customer is required to take note of manufacturer's specification of used components. Such specifications, if applicable, contain additional information that must be taken note of for the safe and reliable operation.

All Embedded Artists' products are sold pursuant to Embedded Artists' terms and conditions of sale: http://www.embeddedartists.com/sites/default/files/docs/General_Terms_and_Conditions.pdf

No license, express or implied, by estoppel or otherwise, to any intellectual property rights is granted under this document. If any part of this document refers to any third party products or services it shall not be deemed a license grant by Embedded Artists for the use of such third party products or services, or any intellectual property contained therein or considered as a warranty covering the use in any manner whatsoever of such third party products or services or any intellectual property contained therein.

UNLESS OTHERWISE SET FORTH IN EMBEDDED ARTISTS' TERMS AND CONDITIONS OF SALE EMBEDDED ARTISTS DISCLAIMS ANY EXPRESS OR IMPLIED WARRANTY WITH RESPECT TO THE USE AND/OR SALE OF EMBEDDED ARTISTS PRODUCTS INCLUDING WITHOUT LIMITATION IMPLIED WARRANTIES OF MERCHANTABILITY, FITNESS FOR A PARTICULAR PURPOSE (AND THEIR EQUIVALENTS UNDER THE LAWS OF ANY JURISDICTION), OR INFRINGEMENT OF ANY PATENT, COPYRIGHT OR OTHER INTELLECTUAL PROPERTY RIGHT.

UNLESS EXPRESSLY APPROVED IN WRITING BY THE CEO OF EMBEDDED ARTISTS, PRODUCTS ARE NOT RECOMMENDED, AUTHORIZED OR WARRANTED FOR USE IN MILITARY, AIR CRAFT, SPACE, NUCLEAR, LIFE SAVING, OR LIFE SUSTAINING APPLICATIONS, NOR IN PRODUCTS OR SYSTEMS WHERE FAILURE OR MALFUNCTION MAY RESULT IN PERSONAL INJURY, DEATH, OR SEVERE PROPERTY OR ENVIRONMENTAL DAMAGE.

Resale of Embedded Artists' products with provisions different from the statements and/or technical features set forth in this document shall immediately void any warranty granted by Embedded Artists

for the Embedded Artists' product or service described herein and shall not create or extend in any manner whatsoever, any liability of Embedded Artists.

This document as well as the item(s) described herein may be subject to export control regulations. Export might require a prior authorization from national authorities.

7.1 Definition of Document Status

Preliminary – The document is a draft version only. The content is still under internal review and subject to formal approval, which may result in modifications or additions. Embedded Artists does not give any representations or warranties as to the accuracy or completeness of information included herein and shall have no liability for the consequences of use of such information. The document is in this state until the product has passed Embedded Artists product qualification tests.

Approved – The information and data provided define the specification of the product as agreed between Embedded Artists and its customer, unless Embedded Artists and customer have explicitly agreed otherwise in writing.