

CSD18503Q5A 40 V N-Channel NexFET™ Power MOSFET

1 Features

- Ultra-Low Q_g and Q_{gd}
- Low Thermal Resistance
- Avalanche Rated
- Logic Level
- Pb Free Terminal Plating
- RoHS Compliant
- Halogen Free
- SON 5 mm × 6 mm Plastic Package

2 Applications

- DC-DC Conversion
- Secondary Side Synchronous Rectifier
- Battery Motor Control

3 Description

This 40 V, 3.4 mΩ, 5 x 6 mm SON NexFET™ power MOSFET is designed to minimize losses in power conversion applications.

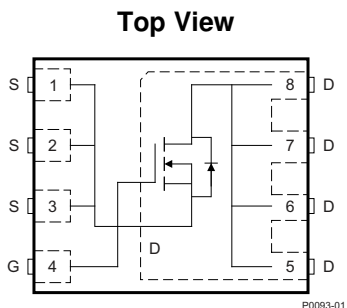

Product Summary

$T_A = 25^\circ\text{C}$		TYPICAL VALUE		UNIT
V_{DS}	Drain-to-source voltage	40		V
Q_g	Gate charge total (4.5 V)	13		nC
Q_{gd}	Gate charge gate-to-drain	4.3		nC
$R_{DS(on)}$	Drain-to-source on-resistance	$V_{GS} = 4.5\text{ V}$	4.7	mΩ
		$V_{GS} = 10\text{ V}$	3.4	mΩ
$V_{GS(th)}$	Threshold voltage	1.8		V

Ordering Information⁽¹⁾

DEVICE	QTY	MEDIA	PACKAGE	SHIP
CSD18503Q5A	2500	13-Inch Reel	SON 5 mm × 6 mm Plastic Package	Tape and Reel
CSD18503Q5AT	250	7-Inch Reel		

(1) For all available packages, see the orderable addendum at the end of the data sheet.

Absolute Maximum Ratings

$T_A = 25^\circ\text{C}$		VALUE	UNIT
V_{DS}	Drain-to-source voltage	40	V
V_{GS}	Gate-to-source voltage	±20	V
I_D	Continuous drain current (package limited), $T_C = 25^\circ\text{C}$	100	A
	Continuous drain current (silicon limited), $T_C = 25^\circ\text{C}$	121	
	Continuous drain current, $T_A = 25^\circ\text{C}^{(1)}$	19	
I_{DM}	Pulsed drain current, $T_A = 25^\circ\text{C}^{(2)}$	321	A
P_D	Power dissipation ⁽¹⁾	3.1	W
	Power dissipation, $T_C = 25^\circ\text{C}$	120	
T_J, T_{stg}	Operating junction, Storage temperature	-55 to 150	°C
E_{AS}	Avalanche energy, single pulse $I_D = 56\text{ A}$, $L = 0.1\text{ mH}$, $R_G = 25\ \Omega$	157	mJ

(1) Typical $R_{\theta JA} = 40^\circ\text{C/W}$ on a 1 inch², 2 oz. Cu pad on a 0.06 inch thick FR4 PCB.

(2) Max $R_{\theta JC} = 1.3^\circ\text{C/W}$, pulse duration ≤100 μs, duty cycle ≤1%

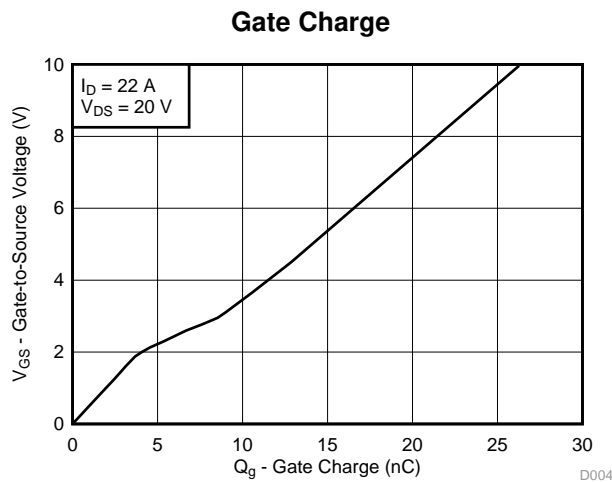
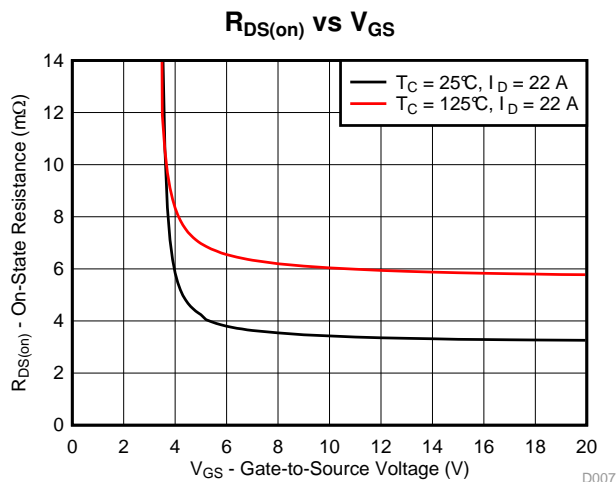

Table of Contents

1 Features 1 2 Applications 1 3 Description 1 4 Revision History 2 5 Specifications 3 5.1 Electrical Characteristics 3 5.2 Thermal Information 3 5.3 Typical MOSFET Characteristics 4 6 Device and Documentation Support 7	6.1 Community Resources 7 6.2 Trademarks 7 6.3 Electrostatic Discharge Caution 7 6.4 Glossary 7 7 Mechanical, Packaging, and Orderable Information 8 7.1 Q5A Package Dimensions 8 7.2 Recommended PCB Pattern 9 7.3 Recommended Stencil Opening 10 7.4 Q5A Tape and Reel Information 10
----------------------------------------------------------------------------------------------------------------------------------------------------------------------------------------------------------------------------------------------------------------------------------------------------------------------------------------------------	------------------------------------------------------------------------------------------------------------------------------------------------------------------------------------------------------------------------------------------------------------------------------------------------------------------------------------------------------------------------------

4 Revision History

NOTE: Page numbers for previous revisions may differ from page numbers in the current version.

Changes from Revision B (November 2012) to Revision C	Page
• Added part number to title	1
• Added 7-inch reel to Ordering Information table	1
• Updated Continuous Drain Current	1
• Updated Pulsed Drain Current	1
• Updated pulsed current conditions	1
• Updated Max $R_{\theta JC}$	3
• Updated Figure 1	4
• Updated SOA in Figure 10	6
• Updated Figure 12	6
• Added Community Resources	7
• Updated package dimensions	8
• Added Recommended Stencil Opening	10

Changes from Revision A (October 2012) to Revision B	Page
• Added line for max power dissipation with case temperature held to 25° C	1
• Changed the $R_{DS(on)}$ vs V_{GS} and GATE CHARGE graphs	1
• Changed Max $R_{\theta JA} = 121^{\circ}\text{C/W}$ To: Max $R_{\theta JA} = 125^{\circ}\text{C/W}$	4
• Changed the Typical MOSFET Characteristics section	4

Changes from Original (June 2012) to Revision A	Page
• Changed the Transconductance TYP value From: 127 S To: 100 S	3
• Changed the Turn On and Turn Off Delay Time, Rise and Fall Time Test Conditions From: $I_{DS} = 22\text{ A}$, $R_G = 2\ \Omega$ To: $I_{DS} = 22\text{ A}$, $R_G = 0\ \Omega$	3
• Changed the Q_{rr} Reverse Recovery Charge TYP value From: 22 nC To: 52 nC	3

5 Specifications

5.1 Electrical Characteristics

($T_A = 25^\circ\text{C}$ unless otherwise stated)

PARAMETER		TEST CONDITIONS	MIN	TYP	MAX	UNIT
STATIC CHARACTERISTICS						
V_{DSS}	Drain to-source voltage	$V_{GS} = 0\text{ V}, I_D = 250\ \mu\text{A}$	40			V
I_{DSS}	Drain-to-source leakage current	$V_{GS} = 0\text{ V}, V_{DS} = 32\text{ V}$			1	μA
I_{GSS}	Gate-to-source leakage current	$V_{DS} = 0\text{ V}, V_{GS} = 20\text{ V}$			100	nA
$V_{GS(th)}$	Gate-to-source threshold voltage	$V_{DS} = V_{GS}, I_D = 250\ \mu\text{A}$	1.5	1.8	2.3	V
$R_{DS(on)}$	Drain-to-source on-resistance	$V_{GS} = 4.5\text{ V}, I_D = 22\text{ A}$		4.7	6.2	m Ω
		$V_{GS} = 10\text{ V}, I_D = 22\text{ A}$		3.4	4.3	m Ω
g_{fs}	Transconductance	$V_{DS} = 20\text{ V}, I_D = 22\text{ A}$		100		S
DYNAMIC CHARACTERISTICS						
C_{iss}	Input capacitance	$V_{GS} = 0\text{ V}, V_{DS} = 20\text{ V}, f = 1\text{ MHz}$		2200	2640	pF
C_{oss}	Output capacitance			510	612	pF
C_{rss}	Reverse transfer capacitance			13	16	pF
R_G	Series gate resistance			1.2	2.4	Ω
Q_g	Gate charge total (4.5 V)	$V_{DS} = 20\text{ V}, I_D = 22\text{ A}$		13	16	nC
Q_g	Gate charge total (10 V)			27	32	
Q_{gd}	Gate charge gate-to-drain			4.3		nC
Q_{gs}	Gate charge gate-to-source			4.5		nC
$Q_{g(th)}$	Gate charge at V_{th}			3.8		nC
Q_{oss}	Output charge		$V_{DS} = 20\text{ V}, V_{GS} = 0\text{ V}$		30	
$t_{d(on)}$	Turn on delay time	$V_{DS} = 20\text{ V}, V_{GS} = 10\text{ V}, I_{DS} = 22\text{ A}, R_G = 0$		4.5		ns
t_r	Rise time			8.8		ns
$t_{d(off)}$	Turn off delay time			15		ns
t_f	Fall time			2.6		ns
DIODE CHARACTERISTICS						
V_{SD}	Diode forward voltage	$I_{SD} = 22\text{ A}, V_{GS} = 0\text{ V}$		0.8	1	V
Q_{rr}	Reverse recovery charge	$V_{DS} = 20\text{ V}, I_F = 22\text{ A}, di/dt = 300\text{ A}/\mu\text{s}$		52		nC
t_{rr}	Reverse recovery time			37		ns

5.2 Thermal Information

($T_A = 25^\circ\text{C}$ unless otherwise stated)

THERMAL METRIC		MIN	TYP	MAX	UNIT
$R_{\theta JC}$	Junction-to-case thermal resistance ⁽¹⁾			1.3	$^\circ\text{C}/\text{W}$
$R_{\theta JA}$	Junction-to-ambient thermal resistance ⁽¹⁾⁽²⁾			50	$^\circ\text{C}/\text{W}$

- (1) $R_{\theta JC}$ is determined with the device mounted on a 1 inch² (6.45 cm²), 2 oz. (0.071 mm thick) Cu pad on a 1.5 inch × 1.5 inch (3.81 cm × 3.81 cm), 0.06 inch (1.52 mm) thick FR4 PCB. $R_{\theta JC}$ is specified by design, whereas $R_{\theta JA}$ is determined by the user's board design.
- (2) Device mounted on FR4 material with 1 inch² (6.45 cm²), 2 oz. (0.071 mm thick) Cu.

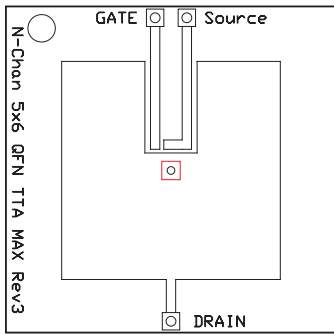

M0137-01

Max $R_{\theta JA} = 50^{\circ}\text{C/W}$
when mounted on
1 inch² (6.45 cm²) of
2 oz. (0.071 mm thick)
Cu.

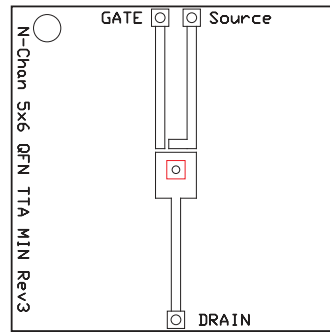

M0137-02

Max $R_{\theta JA} = 125^{\circ}\text{C/W}$
when mounted on a
minimum pad area of
2 oz. (0.071 mm thick)
Cu.

5.3 Typical MOSFET Characteristics

($T_A = 25^{\circ}\text{C}$ unless otherwise stated)

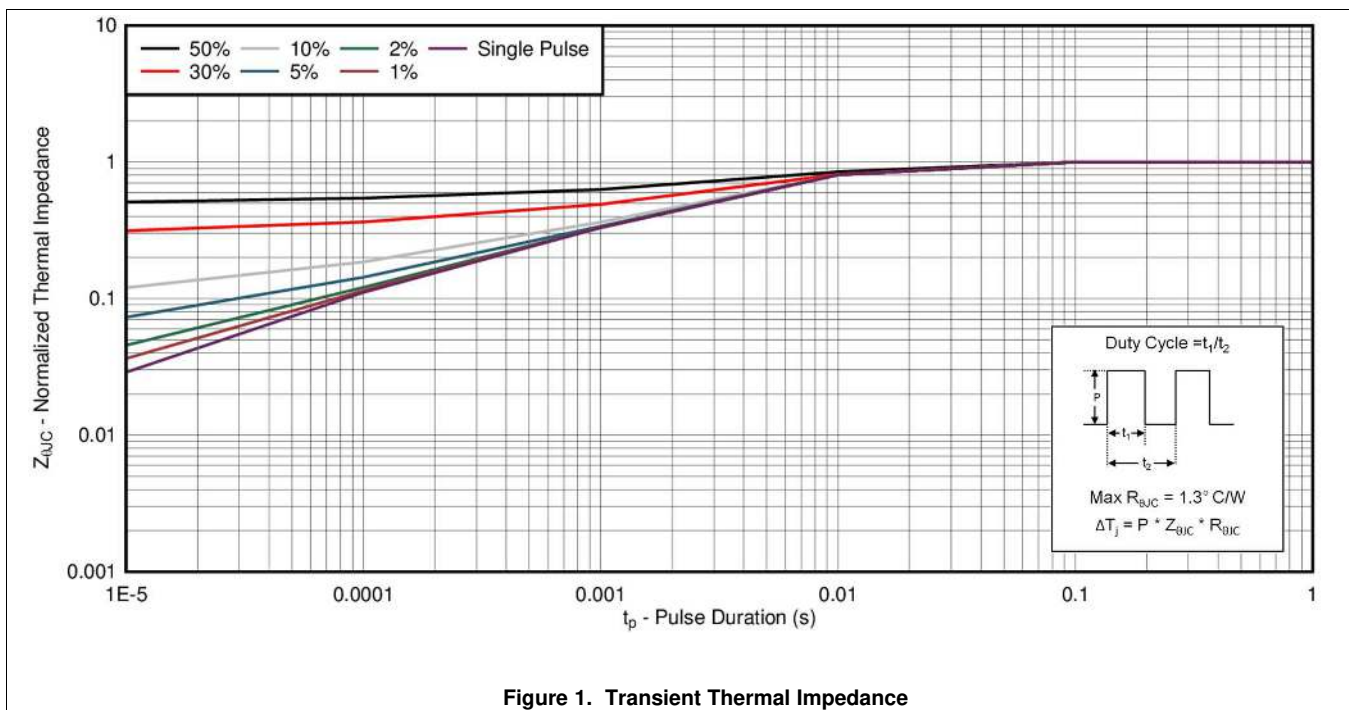

Typical MOSFET Characteristics (continued)

($T_A = 25^\circ\text{C}$ unless otherwise stated)

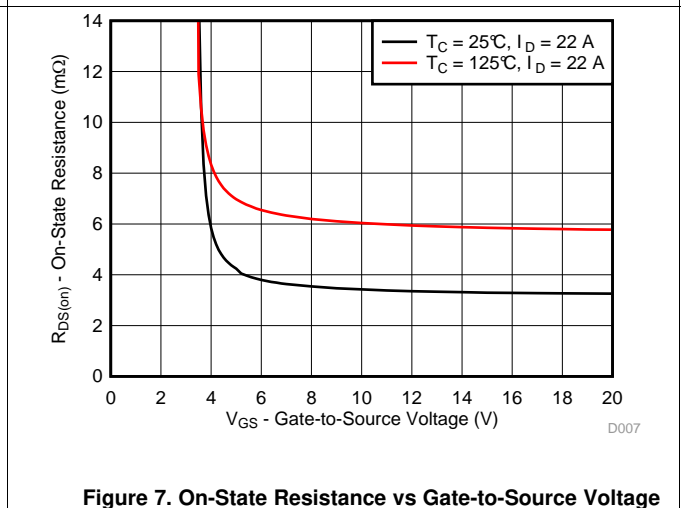
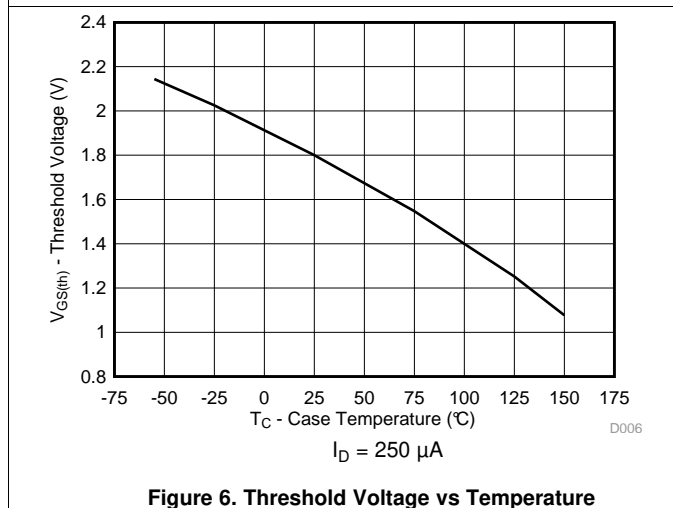
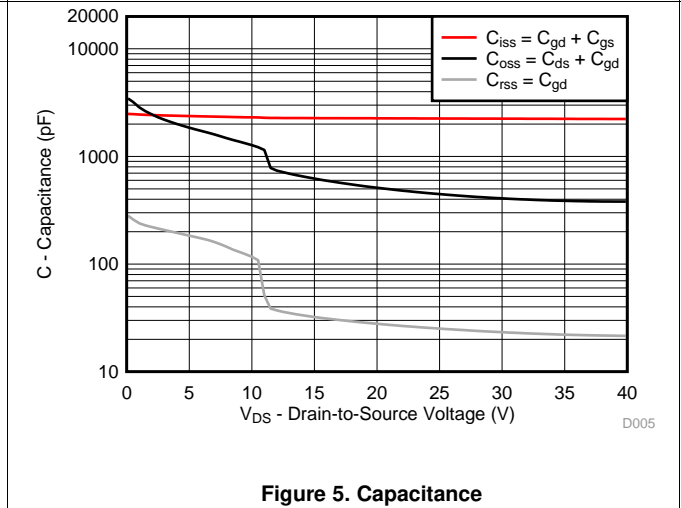
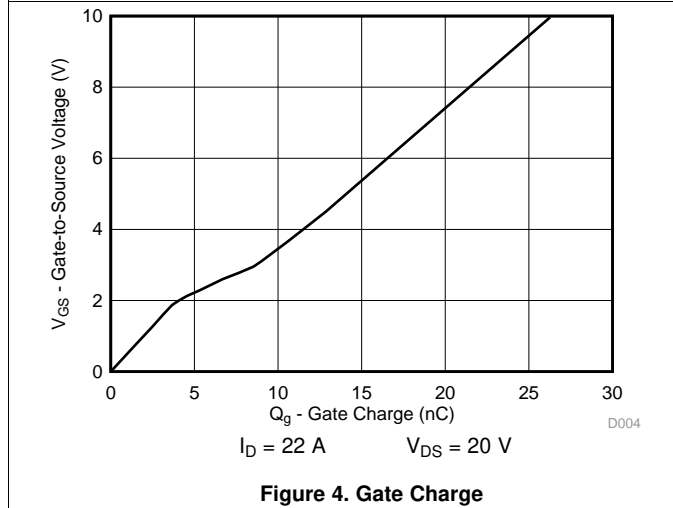
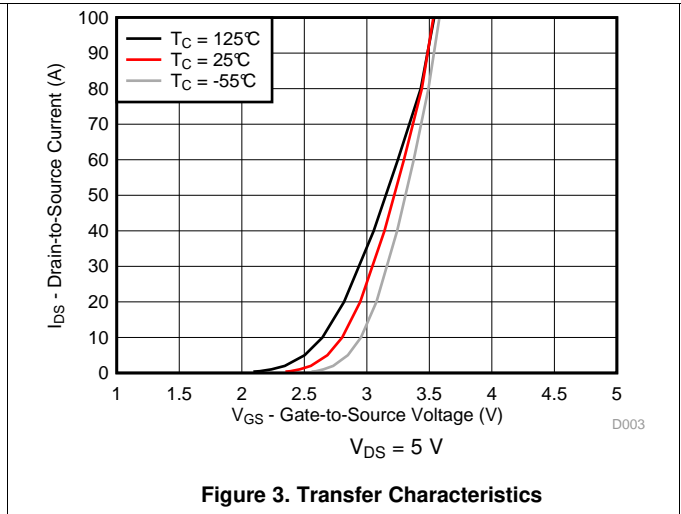
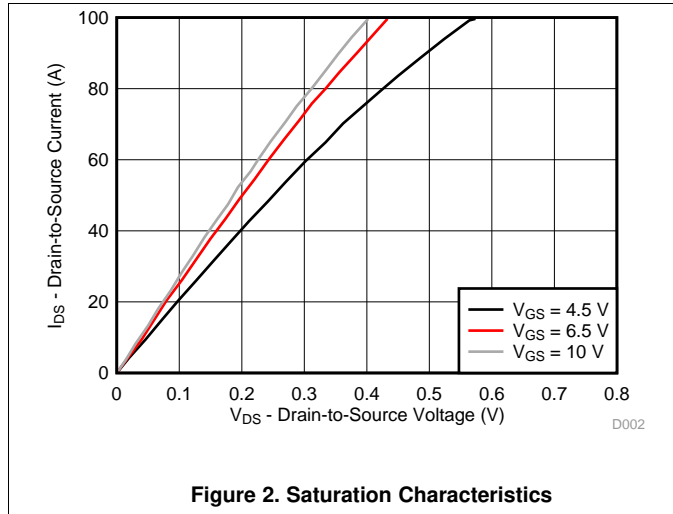

Typical MOSFET Characteristics (continued)

($T_A = 25^\circ\text{C}$ unless otherwise stated)

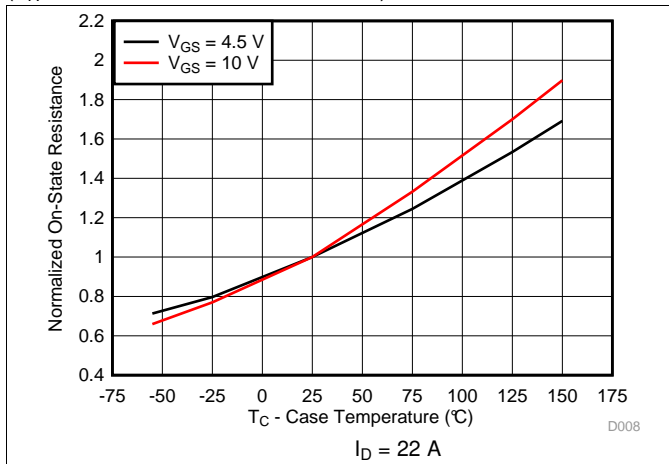

Figure 8. Normalized On-State Resistance vs Temperature

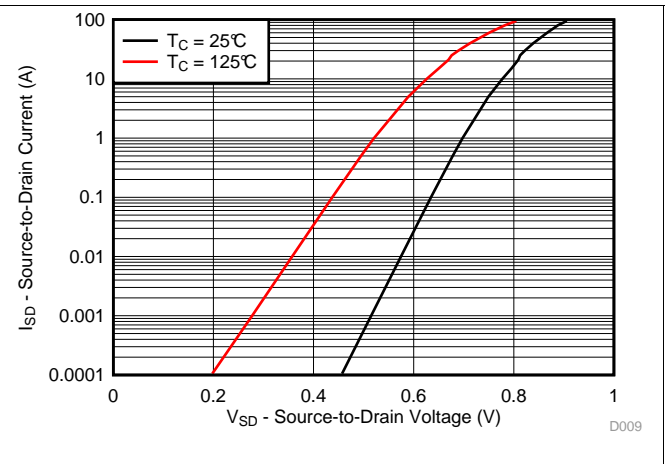

Figure 9. Typical Diode Forward Voltage

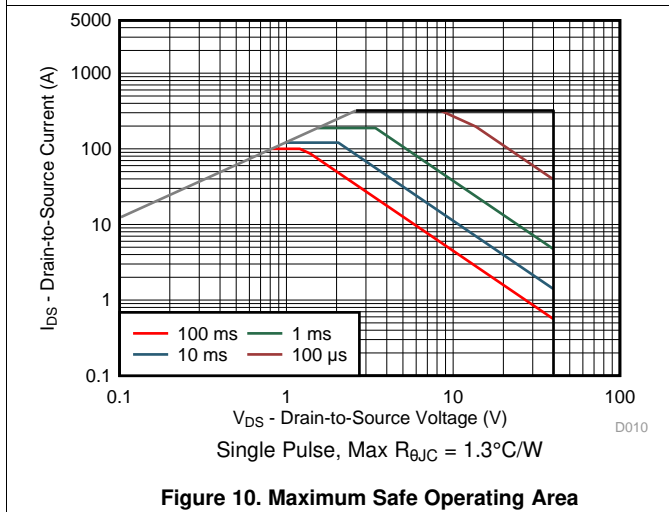

Figure 10. Maximum Safe Operating Area

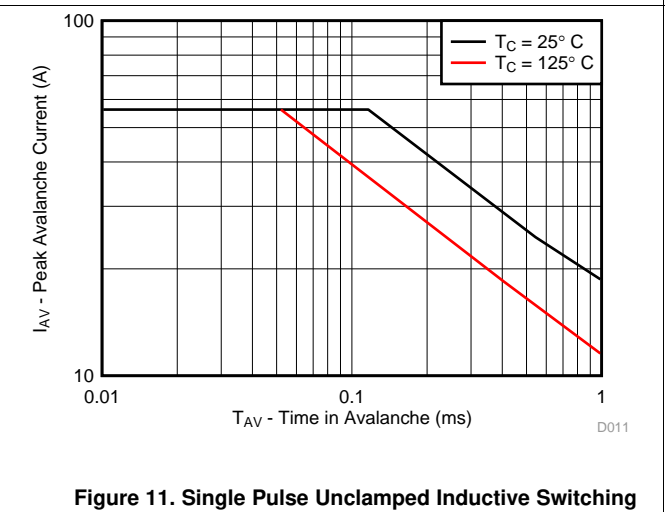

Figure 11. Single Pulse Unclamped Inductive Switching

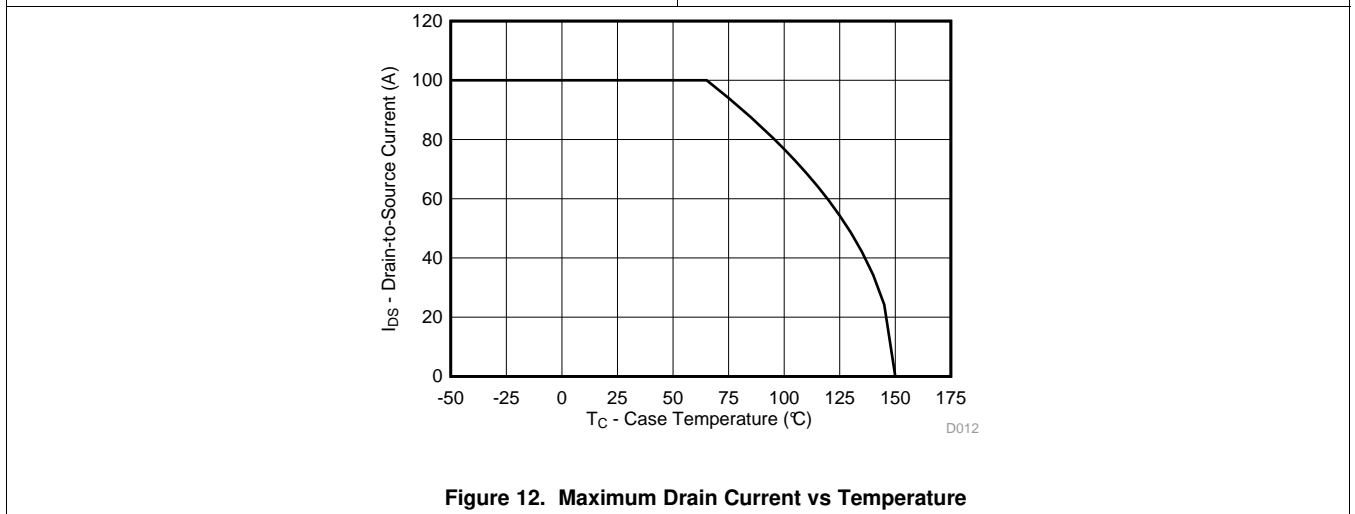

Figure 12. Maximum Drain Current vs Temperature

6 Device and Documentation Support

6.1 Community Resources

The following links connect to TI community resources. Linked contents are provided "AS IS" by the respective contributors. They do not constitute TI specifications and do not necessarily reflect TI's views; see TI's [Terms of Use](#).

TI E2E™ Online Community *TI's Engineer-to-Engineer (E2E) Community*. Created to foster collaboration among engineers. At e2e.ti.com, you can ask questions, share knowledge, explore ideas and help solve problems with fellow engineers.

Design Support *TI's Design Support* Quickly find helpful E2E forums along with design support tools and contact information for technical support.

6.2 Trademarks

NexFET, E2E are trademarks of Texas Instruments.
All other trademarks are the property of their respective owners.

6.3 Electrostatic Discharge Caution



These devices have limited built-in ESD protection. The leads should be shorted together or the device placed in conductive foam during storage or handling to prevent electrostatic damage to the MOS gates.

6.4 Glossary

[SLYZ022](#) — *TI Glossary*.

This glossary lists and explains terms, acronyms, and definitions.

7 Mechanical, Packaging, and Orderable Information

The following pages include mechanical, packaging, and orderable information. This information is the most current data available for the designated devices. This data is subject to change without notice and revision of this document. For browser-based versions of this data sheet, refer to the left-hand navigation.

7.1 Q5A Package Dimensions

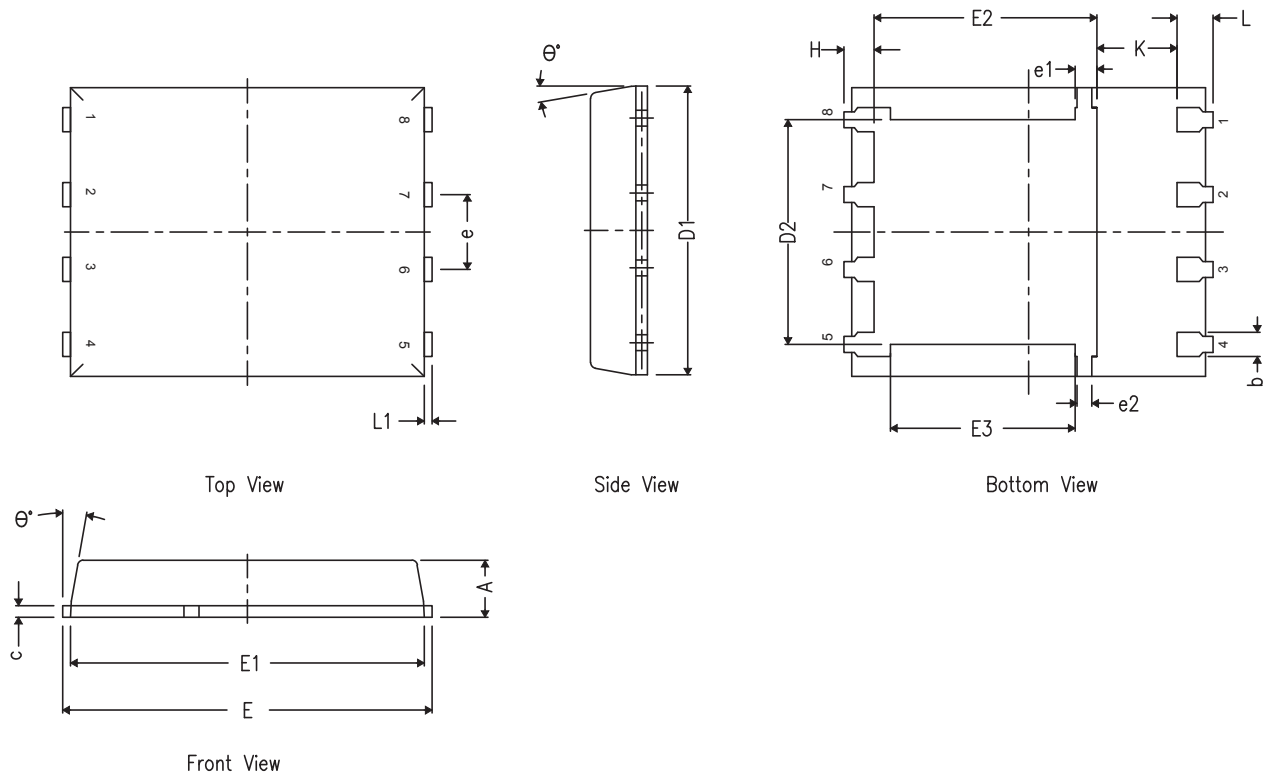

DIM	MILLIMETERS		
	MIN	NOM	MAX
A	0.90	1.00	1.10
b	0.33	0.41	0.51
c	0.20	0.25	0.34
D1	4.80	4.90	5.00
D2	3.61	3.81	4.02
E	5.90	6.00	6.10
E1	5.70	5.75	5.80
E2	3.38	3.58	3.78
E3	3.03	3.13	3.23
e	1.17	1.27	1.37
e1	0.27	0.37	0.47
e2	0.15	0.25	0.35
H	0.41	0.56	0.71
K	1.10		
L	0.51	0.61	0.71
L1	0.06	0.13	0.20
θ	0°		12°

7.2 Recommended PCB Pattern

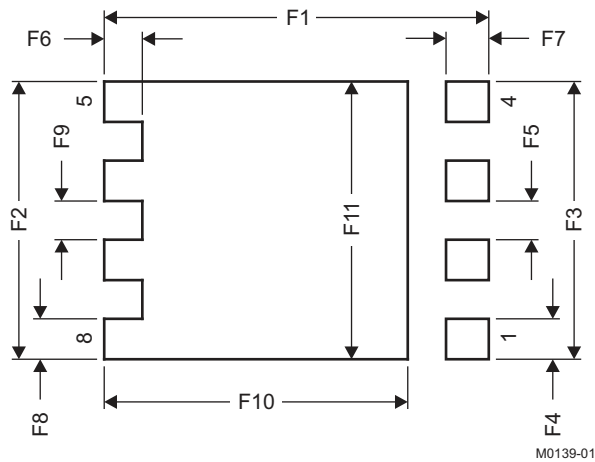

DIM	MILLIMETERS		INCHES	
	MIN	MAX	MIN	MAX
F1	6.205	6.305	0.244	0.248
F2	4.46	4.56	0.176	0.18
F3	4.46	4.56	0.176	0.18
F4	0.65	0.7	0.026	0.028
F5	0.62	0.67	0.024	0.026
F6	0.63	0.68	0.025	0.027
F7	0.7	0.8	0.028	0.031
F8	0.65	0.7	0.026	0.028
F9	0.62	0.67	0.024	0.026
F10	4.9	5	0.193	0.197
F11	4.46	4.56	0.176	0.18

For recommended circuit layout for PCB designs, see application note [SLPA005](#) – *Reducing Ringing Through PCB Layout Techniques*.

7.3 Recommended Stencil Opening

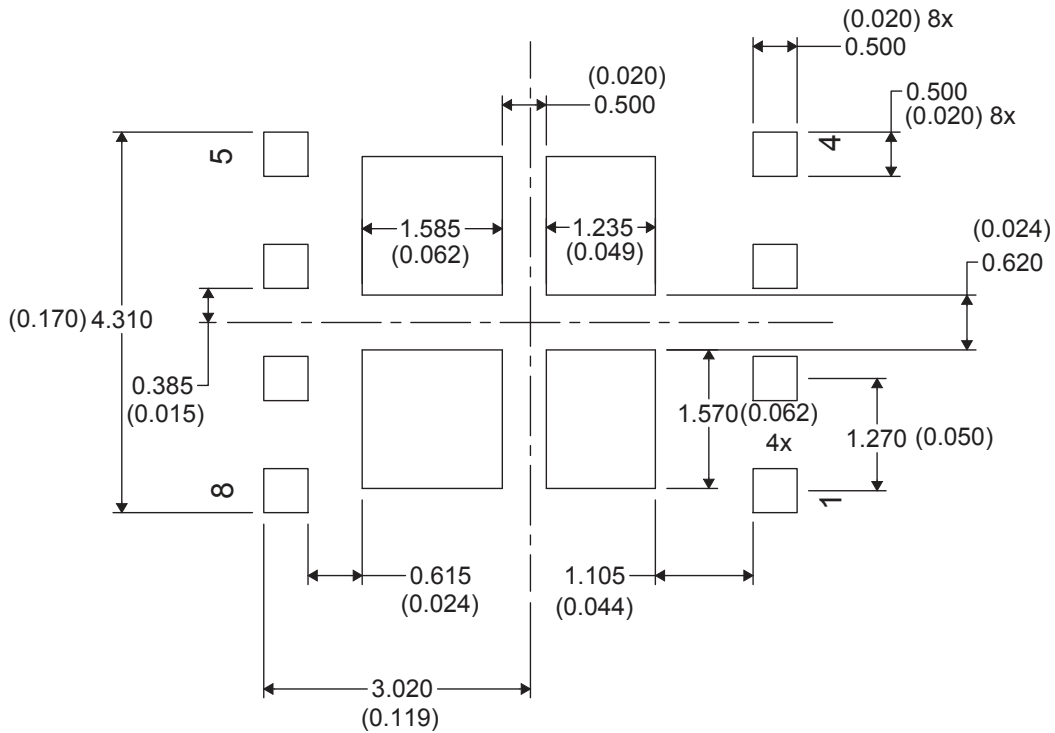

7.4 Q5A Tape and Reel Information

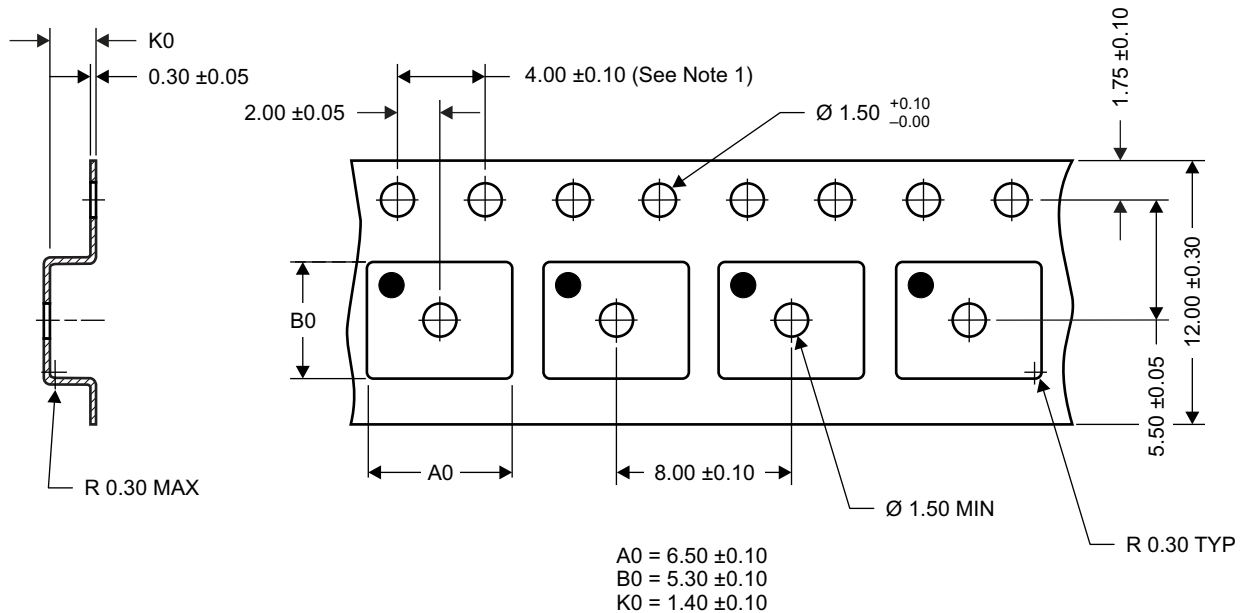



M0138-01

Notes:

1. 10-sprocket hole-pitch cumulative tolerance ± 0.2
2. Camber not to exceed 1 mm in 100 mm, noncumulative over 250 mm
3. Material: black static-dissipative polystyrene
4. All dimensions are in mm (unless otherwise specified)
5. A0 and B0 measured on a plane 0.3 mm above the bottom of the pocket

PACKAGING INFORMATION

Orderable Device	Status (1)	Package Type	Package Drawing	Pins	Package Qty	Eco Plan (2)	Lead finish/ Ball material (6)	MSL Peak Temp (3)	Op Temp (°C)	Device Marking (4/5)	Samples
CSD18503Q5A	ACTIVE	VSONP	DQJ	8	2500	RoHS-Exempt & Green	SN	Level-1-260C-UNLIM	-55 to 150	CSD18503	
CSD18503Q5AT	ACTIVE	VSONP	DQJ	8	250	RoHS-Exempt & Green	SN	Level-1-260C-UNLIM	-55 to 150	CSD18503	

(1) The marketing status values are defined as follows:

ACTIVE: Product device recommended for new designs.

LIFEBUY: TI has announced that the device will be discontinued, and a lifetime-buy period is in effect.

NRND: Not recommended for new designs. Device is in production to support existing customers, but TI does not recommend using this part in a new design.

PREVIEW: Device has been announced but is not in production. Samples may or may not be available.

OBSOLETE: TI has discontinued the production of the device.

(2) **RoHS:** TI defines "RoHS" to mean semiconductor products that are compliant with the current EU RoHS requirements for all 10 RoHS substances, including the requirement that RoHS substance do not exceed 0.1% by weight in homogeneous materials. Where designed to be soldered at high temperatures, "RoHS" products are suitable for use in specified lead-free processes. TI may reference these types of products as "Pb-Free".

RoHS Exempt: TI defines "RoHS Exempt" to mean products that contain lead but are compliant with EU RoHS pursuant to a specific EU RoHS exemption.

Green: TI defines "Green" to mean the content of Chlorine (Cl) and Bromine (Br) based flame retardants meet JS709B low halogen requirements of <=1000ppm threshold. Antimony trioxide based flame retardants must also meet the <=1000ppm threshold requirement.

(3) MSL, Peak Temp. - The Moisture Sensitivity Level rating according to the JEDEC industry standard classifications, and peak solder temperature.

(4) There may be additional marking, which relates to the logo, the lot trace code information, or the environmental category on the device.

(5) Multiple Device Markings will be inside parentheses. Only one Device Marking contained in parentheses and separated by a "~" will appear on a device. If a line is indented then it is a continuation of the previous line and the two combined represent the entire Device Marking for that device.

(6) Lead finish/Ball material - Orderable Devices may have multiple material finish options. Finish options are separated by a vertical ruled line. Lead finish/Ball material values may wrap to two lines if the finish value exceeds the maximum column width.

Important Information and Disclaimer:The information provided on this page represents TI's knowledge and belief as of the date that it is provided. TI bases its knowledge and belief on information provided by third parties, and makes no representation or warranty as to the accuracy of such information. Efforts are underway to better integrate information from third parties. TI has taken and continues to take reasonable steps to provide representative and accurate information but may not have conducted destructive testing or chemical analysis on incoming materials and chemicals. TI and TI suppliers consider certain information to be proprietary, and thus CAS numbers and other limited information may not be available for release.

In no event shall TI's liability arising out of such information exceed the total purchase price of the TI part(s) at issue in this document sold by TI to Customer on an annual basis.

IMPORTANT NOTICE AND DISCLAIMER

TI PROVIDES TECHNICAL AND RELIABILITY DATA (INCLUDING DATASHEETS), DESIGN RESOURCES (INCLUDING REFERENCE DESIGNS), APPLICATION OR OTHER DESIGN ADVICE, WEB TOOLS, SAFETY INFORMATION, AND OTHER RESOURCES "AS IS" AND WITH ALL FAULTS, AND DISCLAIMS ALL WARRANTIES, EXPRESS AND IMPLIED, INCLUDING WITHOUT LIMITATION ANY IMPLIED WARRANTIES OF MERCHANTABILITY, FITNESS FOR A PARTICULAR PURPOSE OR NON-INFRINGEMENT OF THIRD PARTY INTELLECTUAL PROPERTY RIGHTS.

These resources are intended for skilled developers designing with TI products. You are solely responsible for (1) selecting the appropriate TI products for your application, (2) designing, validating and testing your application, and (3) ensuring your application meets applicable standards, and any other safety, security, or other requirements. These resources are subject to change without notice. TI grants you permission to use these resources only for development of an application that uses the TI products described in the resource. Other reproduction and display of these resources is prohibited. No license is granted to any other TI intellectual property right or to any third party intellectual property right. TI disclaims responsibility for, and you will fully indemnify TI and its representatives against, any claims, damages, costs, losses, and liabilities arising out of your use of these resources.

TI's products are provided subject to TI's Terms of Sale (www.ti.com/legal/termsofsale.html) or other applicable terms available either on ti.com or provided in conjunction with such TI products. TI's provision of these resources does not expand or otherwise alter TI's applicable warranties or warranty disclaimers for TI products.

Mailing Address: Texas Instruments, Post Office Box 655303, Dallas, Texas 75265
Copyright © 2020, Texas Instruments Incorporated