

## Low Charge Injection, 8-Channel, Enhanced, High Voltage Analog Switch

### Features

- ▶ HVCMOS technology for high performance
- ▶ 8 Channels of high voltage analog switch
- ▶ 3.3 or 5.0V CMOS input logic level
- ▶ 20MHz data shift clock frequency
- ▶ Very low quiescent power dissipation (-10µA)
- ▶ Low parasitic capacitance
- ▶ DC to 50MHz analog signal frequency
- ▶ -60dB typical off-isolation at 5.0MHz
- ▶ CMOS logic circuitry for low power
- ▶ Excellent noise immunity
- ▶ Cascadable serial data register with latches
- ▶ Flexible operating supply voltages

### Applications

- ▶ Medical ultrasound imaging
- ▶ NDT metal flaw detection
- ▶ Piezoelectric transducer drivers
- ▶ Inkjet printer heads
- ▶ Optical MEMS modules

### General Description

The Supertex HV2201 is a low charge injection, 8-channel, high voltage analog switch integrated circuit (IC). The device can be used in applications requiring high voltage switching controlled by low voltage control signals, such as medical ultrasound imaging, piezoelectric transducer drivers, and printers. The HV2201 is an enhanced version of the HV20220.

Input data is shifted into an 8-bit shift register that can then be retained in an 8-bit latch. To reduce any possible clock feed-through noise, the latch enable bar should be left high until all bits are clocked in. Data is clocked in during the rising edge of the clock. Using HVCMOS technology, this device combines high voltage bilateral DMOS switches and low power CMOS logic to provide efficient control of high voltage analog signals.

The device is suitable for various combinations of high voltage supplies, e.g.,  $V_{PP}/V_{NN}$ : +40V/-160V, +100V/-100V, and +160V/-40V.

### Block Diagram

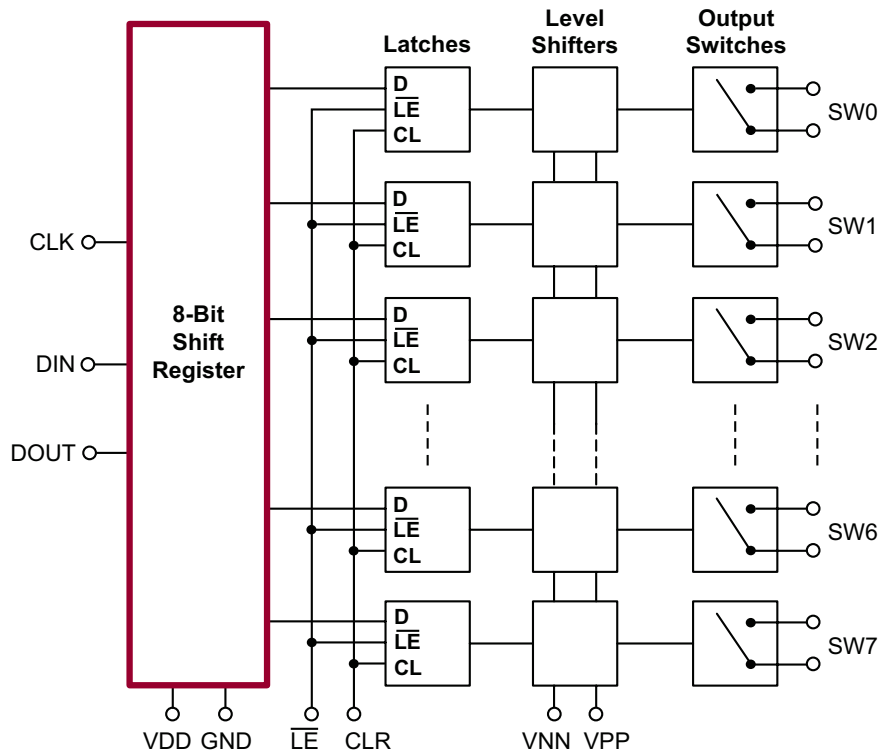

## Ordering Information

Device	Package Options	
	48-Lead LQFP 7.00x7.00mm body 1.60mm height (max) 0.50mm pitch	28-Lead PLCC .453x.453in body .180in height (max) .050in pitch
HV2201	HV2201FG-G	HV2201PJ-G



-G indicates the part is RoHS compliant (Green)

## Absolute Maximum Ratings

Parameter	Value
V <sub>DD</sub> logic supply	-0.5V to +7.0V
V <sub>PP</sub> - V <sub>NN</sub> differential supply	220V
V <sub>PP</sub> positive supply	-0.5V to V <sub>NN</sub> +200V
V <sub>NN</sub> negative supply	+0.5V to -200V
Logic input voltage	-0.5V to V <sub>DD</sub> +0.3V
Analog signal range	V <sub>NN</sub> to V <sub>PP</sub>
Peak analog signal current/channel	3.0A
Storage temperature	-65°C to 150°C
Power dissipation:	
48-Lead LQFP	1.0W
28-Lead PLCC	1.2W

Absolute Maximum Ratings are those values beyond which damage to the device may occur. Functional operation under these conditions is not implied. Continuous operation of the device at the absolute rating level may affect device reliability. All voltages are referenced to device ground.

## Operating Conditions

Sym	Parameter	Value
V <sub>DD</sub>	Logic power supply voltage	3.0V to 5.5V
V <sub>PP</sub>	Positive high voltage supply	40V to V <sub>NN</sub> +200V
V <sub>NN</sub>	Negative high voltage supply	-40V to -160V
V <sub>IH</sub>	High level input voltage	0.9V <sub>DD</sub> to V <sub>DD</sub>
V <sub>IL</sub>	Low-level input voltage	0V to 0.1V <sub>DD</sub>
V <sub>SIG</sub>	Analog signal voltage peak-to-peak	V <sub>NN</sub> +10V to V <sub>PP</sub> -10V
T <sub>A</sub>	Operating free air temperature	0°C to 70°C

### Notes:

- Power up/down sequence is arbitrary except GND must be powered-up first and powered-down last.
- V<sub>SIG</sub> must be V<sub>NN</sub> ≤ V<sub>SIG</sub> ≤ V<sub>PP</sub> or floating during power up/down transition.
- Rise and fall times of power supplies V<sub>DD</sub>, V<sub>PP</sub> and V<sub>NN</sub> should not be less than 1.0msec.

## Pin Configuration

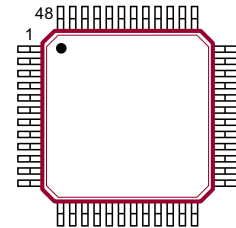

48-Lead LQFP (FG)  
(top view)

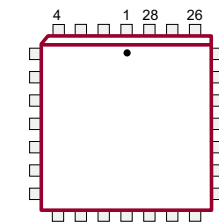

28-Lead PLCC (PJ)  
(top view)

## Product Marking

### Top Marking



### Bottom Marking



YY = Year Sealed  
 WW = Week Sealed  
 L = Lot Number  
 C = Country of Origin\*  
 A = Assembler ID\*  
 — = "Green" Packaging  
 \*May be part of top marking

Package may or may not include the following marks: Si or

### 48-Lead LQFP (FG)

### Top Marking

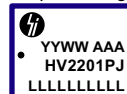

### Bottom Marking

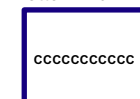

YY = Year Sealed  
 WW = Week Sealed  
 L = Lot Number  
 A = Assembler ID  
 C = Country of Origin\*  
 — = "Green" Packaging  
 \*May be part of top marking

Package may or may not include the following marks: Si or

### 28-Lead PLCC (PJ)

**DC Electrical Characteristics**

(Over operating conditions unless otherwise specified)

Sym	Parameter	0°C		+25°C			+70°C		Units	Conditions	
		Min	Max	Min	Typ	Max	Min	Max			
R <sub>ONS</sub>	Small signal switch on-resistance	-	30	-	26	38	-	48	Ω	I <sub>SIG</sub> = 5.0mA	V <sub>PP</sub> = +40V V <sub>NN</sub> = -160V
		-	25	-	22	27	-	32		I <sub>SIG</sub> = 200mA	V <sub>NN</sub> = -160V
		-	25	-	22	27	-	30		I <sub>SIG</sub> = 5.0mA	V <sub>PP</sub> = +100V V <sub>NN</sub> = -100V
		-	18	-	18	24	-	27		I <sub>SIG</sub> = 200mA	V <sub>NN</sub> = -100V
		-	23	-	20	25	-	30		I <sub>SIG</sub> = 5.0mA	V <sub>PP</sub> = +160V V <sub>NN</sub> = -40V
		-	22	-	16	25	-	27		I <sub>SIG</sub> = 200mA	V <sub>NN</sub> = -40V
ΔR <sub>ONS</sub>	Small signal switch on-resistance matching	-	20	-	5.0	20	-	20	%	I <sub>SIG</sub> = 5.0mA, V <sub>PP</sub> = +100V, V <sub>NN</sub> = -100V	
R <sub>ONL</sub>	Large signal switch on-resistance	-	-	-	15	-	-	-	Ω	V <sub>SIG</sub> = V <sub>PP</sub> -10V, I <sub>SIG</sub> = 1.0A	
I <sub>SOL</sub>	Switch off leakage per switch	-	5.0	-	1.0	10	-	15	μA	V <sub>SIG</sub> = V <sub>PP</sub> -10V, V <sub>NN</sub> +10V	
V <sub>OS</sub>	DC offset switch off	-	300	-	100	300	-	300	mV	100kΩ load	
	DC offset switch on	-	500	-	100	500	-	500	mV		
I <sub>PPQ</sub>	Quiescent V <sub>PP</sub> supply current	-	-	-	10	50	-	-	μA	All switches off	
I <sub>NNQ</sub>	Quiescent V <sub>NN</sub> supply current	-	-	-	-10	-50	-	-	μA	All switches off	
I <sub>PPQ</sub>	Quiescent V <sub>PP</sub> supply current	-	-	-	10	50	-	-	μA	All switches on, I <sub>SW</sub> = 5.0mA	
I <sub>NNQ</sub>	Quiescent V <sub>NN</sub> supply current	-	-	-	-10	-50	-	-	μA	All switches on, I <sub>SW</sub> = 5.0mA	
I <sub>SW</sub>	Switch output peak current	-	3.0	-	3.0	2.0	-	2.0	A	V <sub>SIG</sub> duty cycle < 0.1%	
f <sub>SW</sub>	Output switching frequency	-	-	-	-	50	-	-	kHz	Duty cycle = 50%	
I <sub>PP</sub>	Average V <sub>PP</sub> supply current	-	4.0	-	-	5.0	-	5.5	mA	V <sub>PP</sub> = +40V V <sub>NN</sub> = -160V	All output switches are turning on and off at 50kHz with no load
		-	3.5	-	-	3.5	-	3.5		V <sub>PP</sub> = +100V V <sub>NN</sub> = -100V	
		-	3.5	-	-	3.5	-	4.0		V <sub>PP</sub> = +160V V <sub>NN</sub> = -40V	
I <sub>NN</sub>	Average V <sub>NN</sub> supply current	-	4.5	-	-	5.0	-	5.5	mA	V <sub>PP</sub> = +40V V <sub>NN</sub> = -160V	All output switches are turning on and off at 50kHz with no load
		-	3.5	-	-	3.5	-	3.5		V <sub>PP</sub> = +100V V <sub>NN</sub> = -100V	
		-	3.5	-	-	3.5	-	4.0		V <sub>PP</sub> = +160V V <sub>NN</sub> = -40V	
I <sub>DD</sub>	Average V <sub>DD</sub> supply current	-	4.0	-	-	4.0	-	4.0	mA	f <sub>CLK</sub> = 5MHz, V <sub>DD</sub> = 5.0V	
I <sub>DDQ</sub>	Quiescent V <sub>DD</sub> supply current	-	10	-	-	10	-	10	μA	All logic inputs are static	
I <sub>SOR</sub>	Data out source current	0.45	-	0.45	0.70	-	0.40	-	mA	V <sub>OUT</sub> = V <sub>DD</sub> -0.7V	
I <sub>SINK</sub>	Data out sink current	0.45	-	0.45	0.70	-	0.40	-	mA	V <sub>OUT</sub> = 0.7V	
C <sub>IN</sub>	Logic input capacitance	-	10	-	-	10	-	10	pF	---	

**AC Electrical Characteristics**

(Over recommended operating conditions:  $V_{DD} = 5.0V$ ,  $t_R = t_F \leq 5ns$ , 50% duty cycle,  $C_{LOAD} = 20pF$ , unless otherwise specified)

Sym	Parameter	0°C		+25°C			+70°C		Units	Conditions
		Min	Max	Min	Typ	Max	Min	Max		
$t_{SD}$	Set up time before $\overline{LE}$ rises	25	-	25	-	-	25	-	ns	---
$t_{WLE}$	Time width of $\overline{LE}$	56	-	-	56	-	56	-	ns	$V_{DD} = 3.0V$
		12	-	-	12	-	12	-		$V_{DD} = 5.0V$
$t_{DO}$	Clock delay time to data out	-	120	-	95	140	-	167	ns	$V_{DD} = 3.0V$
		-	58	-	40	69	-	85		$V_{DD} = 5.0V$
$t_{WCL}$	Time width of CL	55	-	55	-	-	55	-	ns	---
$t_{SU}$	Set up time data to clock	39	-	47	30	-	58	-	ns	$V_{DD} = 3.0V$
		16	-	21	10	-	26	-		$V_{DD} = 5.0V$
$t_H$	Hold time data from clock	2	-	2	-	-	2	-	ns	$V_{DD} = 3.0$ or $5.0V$
$f_{CLK}$	Clock frequency	-	-	-	8	-	-	-	MHz	$V_{DD} = 3.0V$
		-	-	-	20	-	-	-		$V_{DD} = 5.0V$
$t_R, t_F$	Clock rise and fall times	-	50	-	-	50	-	50	ns	---
$t_{ON}$	Turn on time	-	5.0	-	-	5.0	-	5.0	$\mu s$	$V_{SIG} = V_{PP} - 10V, R_{LOAD} = 10k\Omega$
$t_{OFF}$	Turn off time	-	5.0	-	-	5.0	-	5.0	$\mu s$	$V_{SIG} = V_{PP} - 10V, R_{LOAD} = 10k\Omega$
dv/dt	Maximun $V_{SIG}$ slew rate	-	20	-	-	20	-	20	V/ns	$V_{PP} = +40V, V_{NN} = -160V$
		-	20	-	-	20	-	20		$V_{PP} = +100V, V_{NN} = -100V$
		-	20	-	-	20	-	20		$V_{PP} = +160V, V_{NN} = -40V$
$K_O$	Off isolation	-30	-	-30	-33	-	-30	-	dB	$f = 5.0MHz, 1.0k\Omega/15pF$ load
		-58	-	-58	-	-	-58	-		$f = 5.0MHz, 50\Omega$ load
$K_{CR}$	Switch crosstalk	-60	-	-60	-70	-	-60	-	dB	$f = 5.0MHz, 50\Omega$ load
$I_{ID}$	Output switch isolation diode current	-	300	-	-	300	-	300	mA	300ns pulse width, 2.0% duty cycle
$C_{SG(OFF)}$	Off capacitance SW to GND	5.0	17	5.0	12	17	5.0	17	pF	0V, $f = 1.0MHz$
$C_{SG(ON)}$	On capacitance SW to GND	25	50	25	38	50	25	50	pF	0V, $f = 1.0MHz$
$+V_{SPK}$	Output voltage spike	-	-	-	-	150	-	-	mV	$V_{PP} = +40V, V_{NN} = -160V, R_{LOAD} = 50\Omega$
$-V_{SPK}$		-	-	-	-	150	-	-		$V_{PP} = +100V, V_{NN} = -100V, R_{LOAD} = 50\Omega$
$+V_{SPK}$		-	-	-	-	150	-	-		$V_{PP} = +160V, V_{NN} = -40V, R_{LOAD} = 50\Omega$
$-V_{SPK}$		-	-	-	-	150	-	-		
$+V_{SPK}$		-	-	-	-	150	-	-		
$-V_{SPK}$		-	-	-	-	150	-	-		
QC	Charge injection	-	-	-	820	-	-	-	pC	$V_{PP} = +40V, V_{NN} = -160V, V_{SIG} = 0V$
		-	-	-	600	-	-	-		$V_{PP} = +100V, V_{NN} = -100V, V_{SIG} = 0V$
		-	-	-	350	-	-	-		$V_{PP} = +160V, V_{NN} = -40V, V_{SIG} = 0V$

## Truth Table

D0	D1	D2	D3	D4	D5	D6	D7	$\overline{LE}$	CLR	SW0	SW1	SW2	SW3	SW4	SW5	SW6	SW7
L								L	L	Off							
H								L	L	On							
	L							L	L		Off						
	H							L	L		On						
		L						L	L			Off					
		H						L	L			On					
			L					L	L				Off				
			H					L	L				On				
				L				L	L					Off			
				H				L	L					On			
					L			L	L						Off		
					H			L	L						On		
						L		L	L							Off	
						H		L	L							On	
							L	L	L								Off
							H	L	L								On
X	X	X	X	X	X	X	X	H	L	Hold Previous State							
X	X	X	X	X	X	X	X	X	H	All Switches Off							

## Notes:

1. The eight switches operate independently.
2. Serial data is clocked in on the L to H transition of the CLK.
3. The switches go to a state retaining their present condition at the rising edge of  $\overline{LE}$ . When  $\overline{LE}$  is low the shift register data flow through the latch.
4.  $D_{OUT}$  is high when data in the shift register 7 is high.
5. Shift register clocking has no effect on the switch states if  $\overline{LE}$  is high.
6. The CLR clear input overrides all other inputs.

Test Circuits

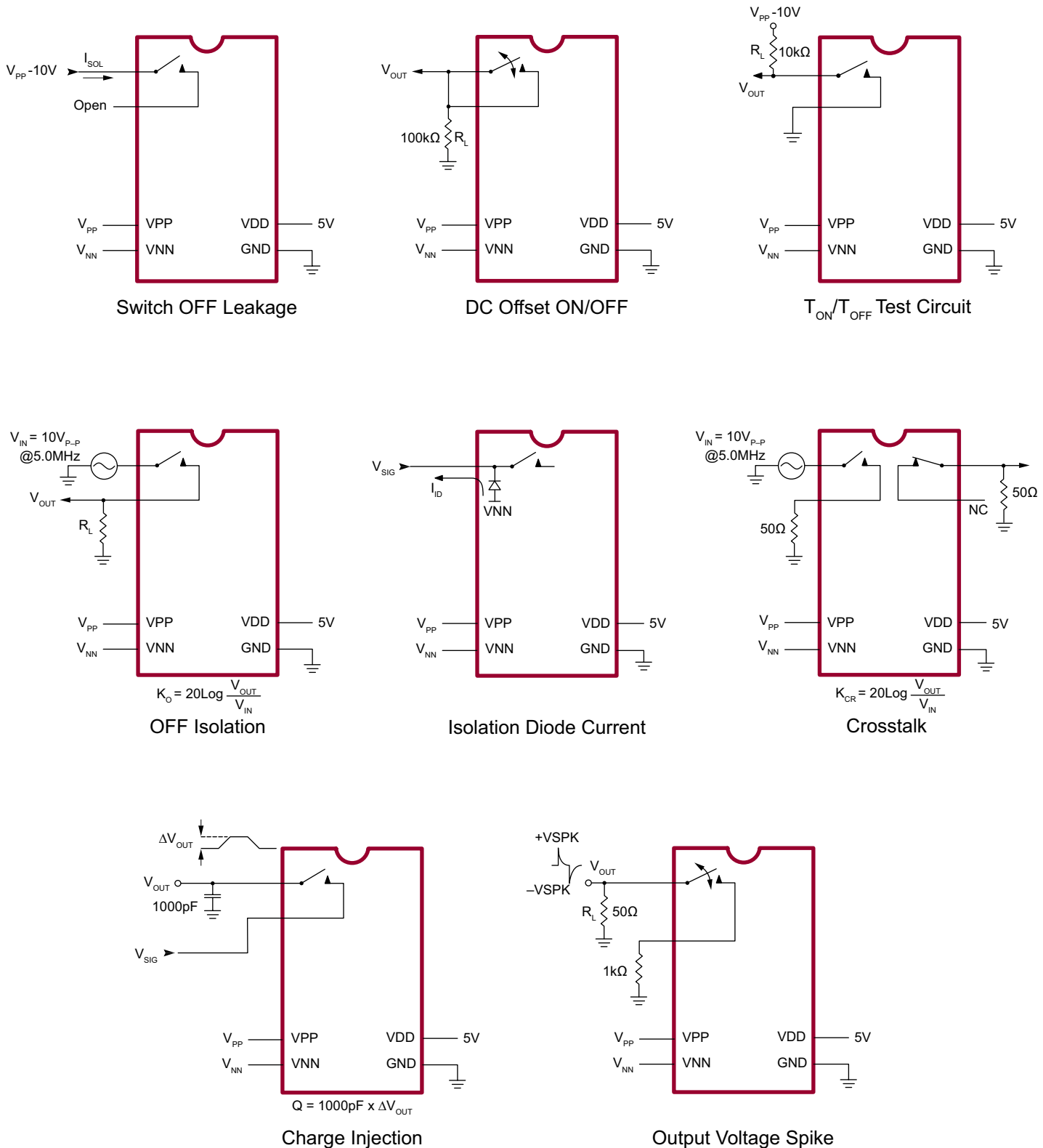

Typical Waveforms

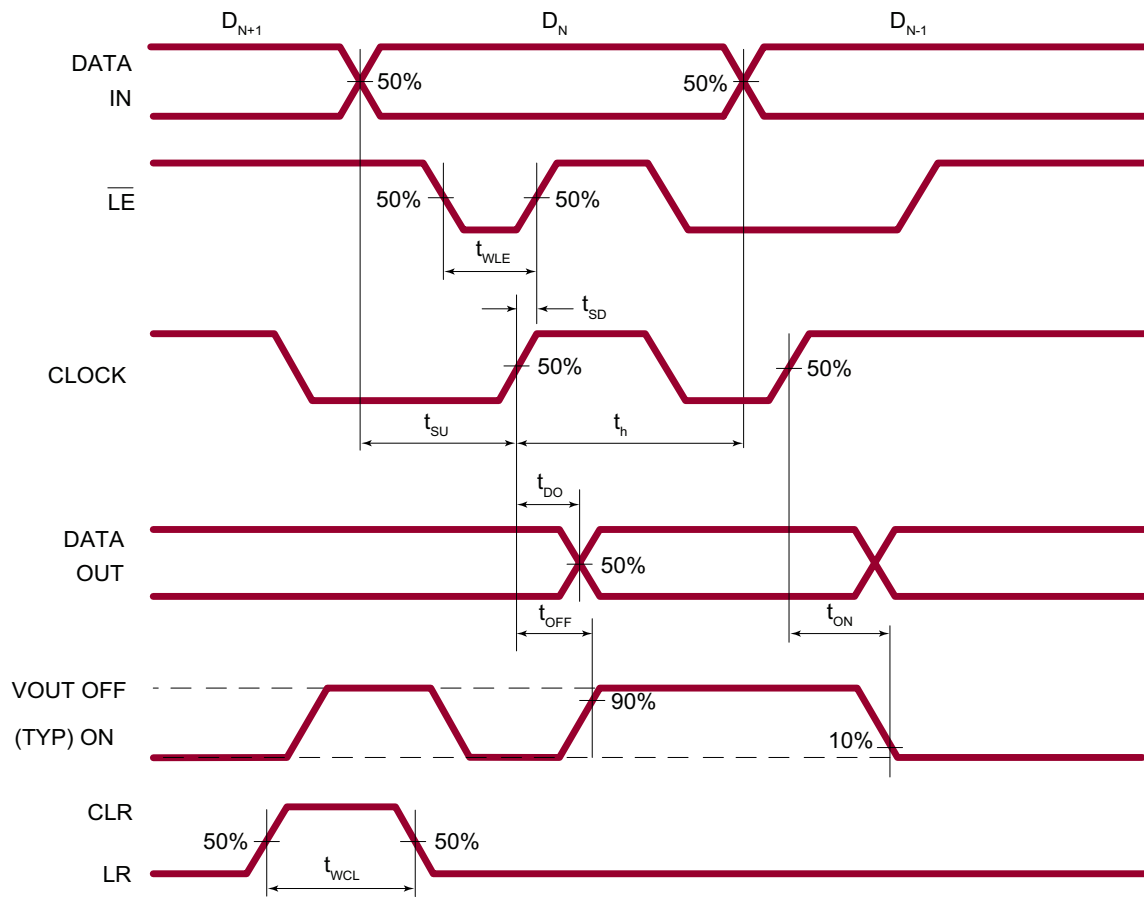

**Pin Configuration  
48-Lead LQFP - (FG)**

Pin #	Pin Name	Pin #	Pin Name
1	SW5	25	VNN
2	NC	26	NC
3	SW4	27	NC
4	NC	28	GND
5	SW4	29	VDD
6	NC	30	NC
7	NC	31	NC
8	SW3	32	NC
9	NC	33	DIN
10	SW3	34	CLK
11	NC	35	$\overline{LE}$
12	SW2	36	CLR
13	NC	37	DOUT
14	SW2	38	NC
15	NC	39	SW7
16	SW1	40	NC
17	NC	41	SW7
18	SW1	42	NC
19	NC	43	SW6
20	SW0	44	NC
21	NC	45	SW6
22	SW0	46	NC
23	NC	47	SW5
24	VPP	48	NC

**Pin Configuration  
28-Lead PLCC (PJ)**

Pin #	Pin Name	Pin #	Pin Name
1	SW3	15	NC
2	SW3	16	DIN
3	SW2	17	CLK
4	SW2	18	$\overline{LE}$
5	SW1	19	CLR
6	SW1	20	DOUT
7	SW0	21	SW7
8	SW0	22	SW7
9	NC	23	SW6
10	VPP	24	SW6
11	NC	25	SW5
12	VNN	26	SW5
13	GND	27	SW4
14	VDD	28	SW4



# 48-Lead LQFP Package Outline (FG)

7.00x7.00mm body, 1.60mm height (max), 0.50mm pitch

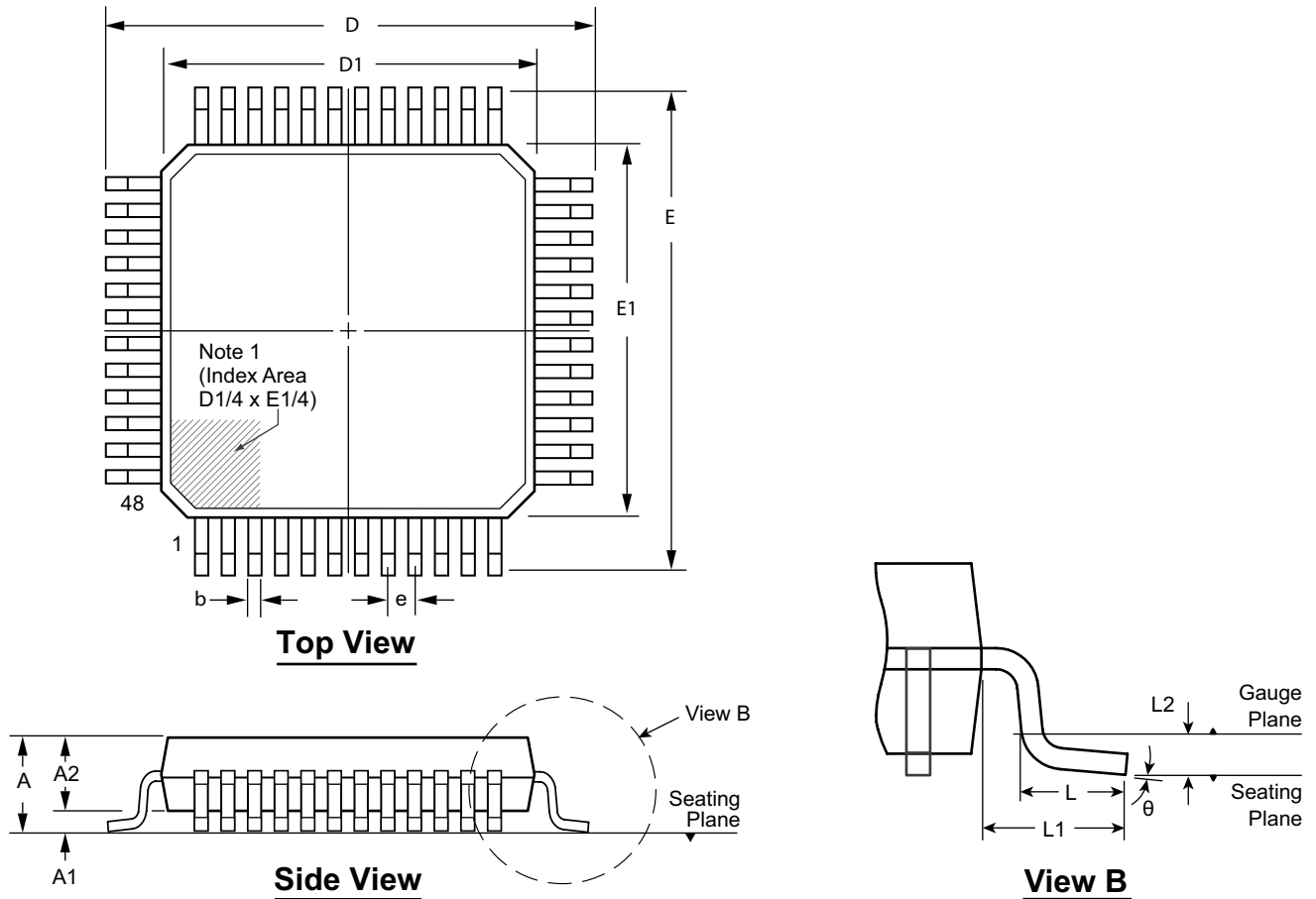

**Note:**  
 1. A Pin 1 identifier must be located in the index area indicated. The Pin 1 identifier can be: a molded mark/identifier; an embedded metal marker; or a printed indicator.

Symbol	A	A1	A2	b	D	D1	E	E1	e	L	L1	L2	$\theta$	
Dimension (mm)	MIN	1.40*	0.05	1.35	0.17	8.80*	6.80*	8.80*	6.80*	0.50 BSC	0.45	1.00 REF	0.25 BSC	0°
	NOM	-	-	1.40	0.22	9.00	7.00	9.00	7.00		0.60		3.5°	
	MAX	1.60	0.15	1.45	0.27	9.20*	7.20*	9.20*	7.20*		0.75		7°	

JEDEC Registration MS-026, Variation BBC, Issue D, Jan. 2001.  
 \* This dimension is not specified in the JEDEC drawing.

**Drawings are not to scale.**  
 Supertex Doc. #: DSPD-48LQFPFG Version, D041309.

# 28-Lead PLCC Package Outline (PJ)

.453x.453in. body, .180in. height (max), .050in. pitch

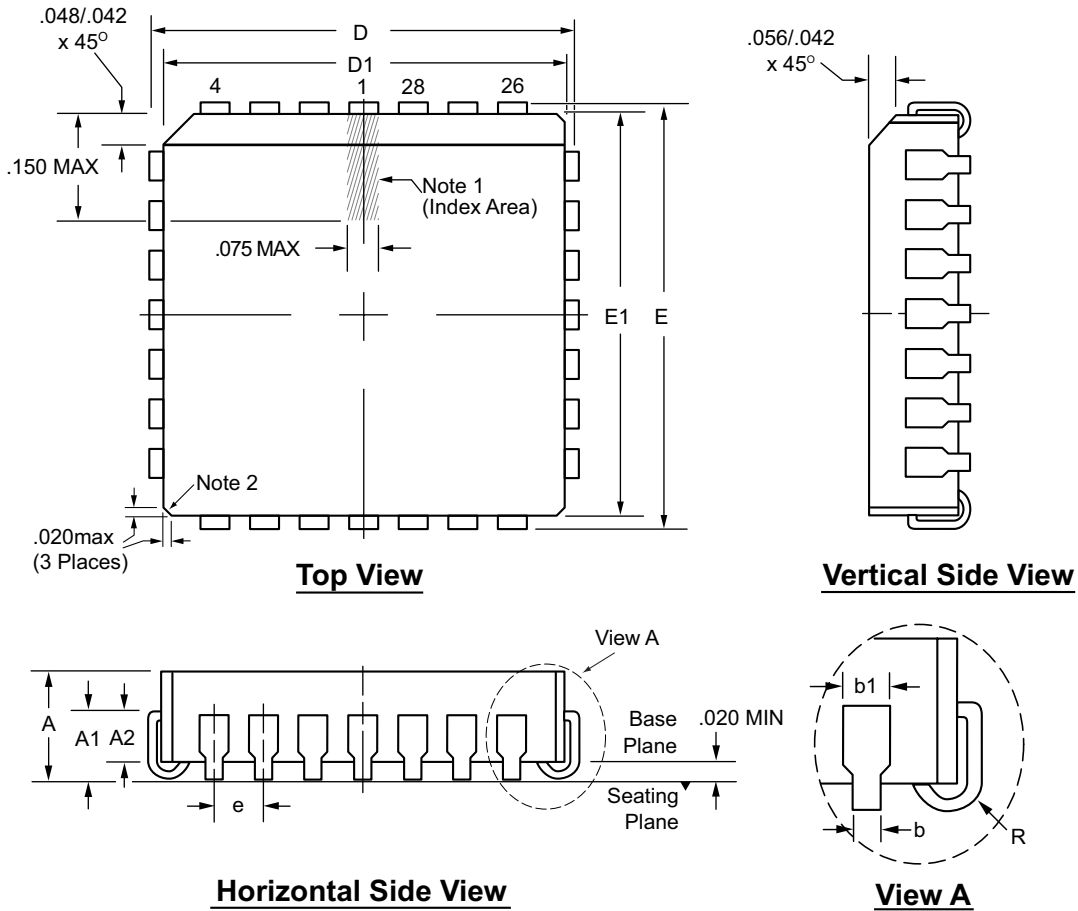

**Notes:**

1. A Pin 1 identifier must be located in the index area indicated. The Pin 1 identifier can be: a molded mark/identifier; an embedded metal marker; or a printed indicator.
2. Actual shape of this feature may vary.

Symbol		A	A1	A2	b	b1	D	D1	E	E1	e	R
Dimension (inches)	MIN	.165	.090	.062	.013	.026	.485	.450	.485	.450	.050 BSC	.025
	NOM	.172	.105	-	-	-	.490	.453	.490	.453		.035
	MAX	.180	.120	.083	.021	.032	.495	.456	.495	.456		.045

JEDEC Registration MS-018, Variation AB, Issue A, June, 1993.

Drawings not to scale.

Supertex Doc. #: DSPD-28PLCCPJ, Version B031111.

(The package drawing(s) in this data sheet may not reflect the most current specifications. For the latest package outline information go to <http://www.supertex.com/packaging.html>.)

Supertex inc. does not recommend the use of its products in life support applications, and will not knowingly sell them for use in such applications unless it receives an adequate "product liability indemnification insurance agreement." Supertex inc. does not assume responsibility for use of devices described, and limits its liability to the replacement of the devices determined defective due to workmanship. No responsibility is assumed for possible omissions and inaccuracies. Circuitry and specifications are subject to change without notice. For the latest product specifications refer to the Supertex inc. (website: <http://www.supertex.com>)