

Features

- Ideal for indication light on hand held products
- Long life and robust package
- Standard Package: 4,000pcs/ Reel
- MSL (Moisture Sensitivity Level): 3
- Low current IF = 5mA operating.
- Halogen-free
- RoHS compliant



ATTENTION
OBSERVE PRECAUTIONS
FOR HANDLING
ELECTROSTATIC
DISCHARGE
SENSITIVE
DEVICES

Package Schematics

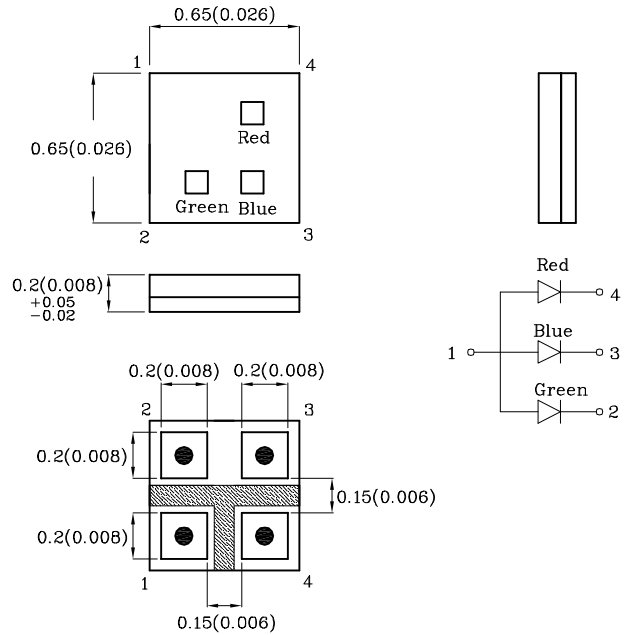

Notes:

1. All dimensions are in millimeters (inches).
2. Tolerance is $\pm 0.1(0.004)$ " unless otherwise noted.
3. Specifications are subject to change without notice.

Absolute Maximum Ratings ($T_A=25^\circ\text{C}$)		Green (InGa N)	Blue (InGa N)	Red (AlGa InP)	Unit
Reverse Voltage	V_R	5	5	5	V
Forward Current [2]	I_F	10	10	10	mA
Forward Current (Peak) Duty Cycle $\leq 1/20$ 1ms Pulse Width	i_{FS}	50	50	50	mA
Power Dissipation [1]	P_D	35	35	35	mW
Electrostatic Discharge Threshold (HBM)		1000	1000	3000	V
Operating Temperature	T_A	-40 ~ +85			°C
Storage Temperature	T_{Stg}	-40 ~ +100			

A Relative Humidity between 40% and 60% is recommended in ESD-protected work areas to reduce static build up during assembly process (Reference JEDEC/JESD625-A and JEDEC/J-STD-033)

Operating Characteristics ($T_A=25^\circ\text{C}$)		Green (InGa N)	Blue (InGa N)	Red (AlGaI nP)	Unit
Forward Voltage (Typ.) ($I_F=5\text{mA}$)	V_F	3	2.9	1.95	V
Forward Voltage (Max.) ($I_F=5\text{mA}$)	V_F	3.2	3.1	2.3	V
Reverse Current (Max.) ($V_R=5\text{V}$)	I_R	50	50	10	μA
Wavelength of Peak Emission CIE127-2007* (Typ.) ($I_F=5\text{mA}$)	λ_P	518*	461*	632*	nm
Wavelength of Dominant Emission CIE127-2007* (Typ.) ($I_F=5\text{mA}$)	λ_D	527*	467*	624*	nm
Spectral Line Full Width At Half-Maximum (Typ.) ($I_F=5\text{mA}$)	$\Delta\lambda$	35	22	20	nm
Capacitance (Typ.) ($V_F=0\text{V}$, $f=1\text{MHz}$)	C	100	110	25	pF

Part Number	Emitting Color	Emitting Material	Lens-color	Luminous Intensity CIE127-2007* ($I_F=5\text{mA}$) mcd		Wavelength CIE127-2007* nm λ_P	Viewing Angle 20 1/2
				min.	typ.		
XZBGRBBRMER158W	Green	InGaN	Water Clear	30*	89*	518*	140°
	Blue	InGaN		5*	19*	461*	
	Red	AlGaInP		15*	24*	632*	

*Luminous intensity value and wavelength are in accordance with CIE127-2007 standards.
Dec 05, 2020

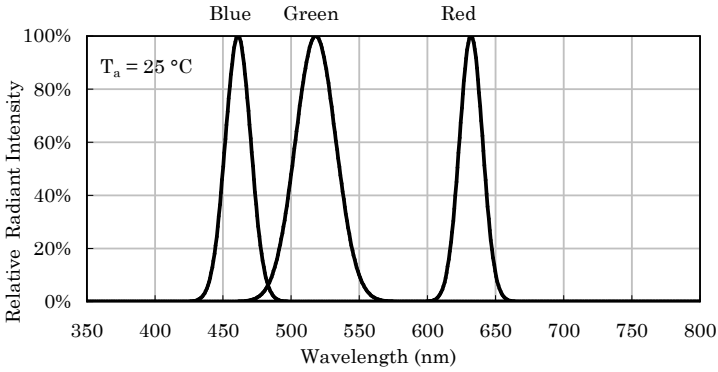

Relative Intensity Vs. CIE Wavelength

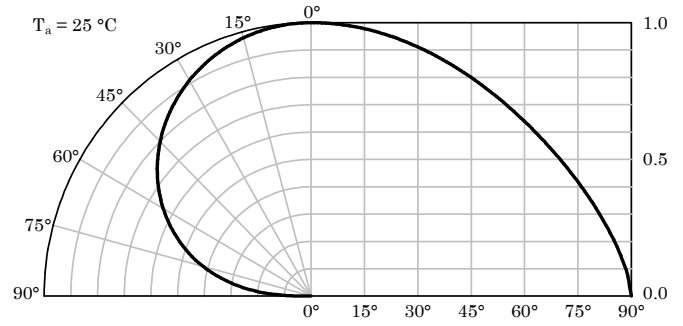

Spatial Distribution

❖ Green

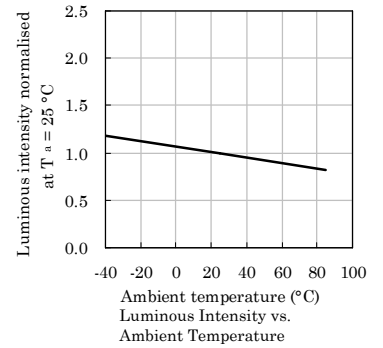
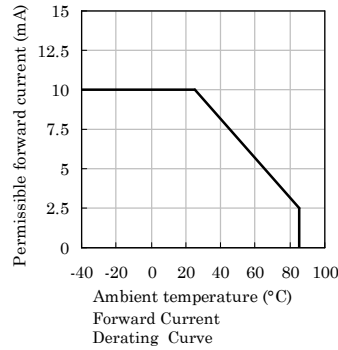
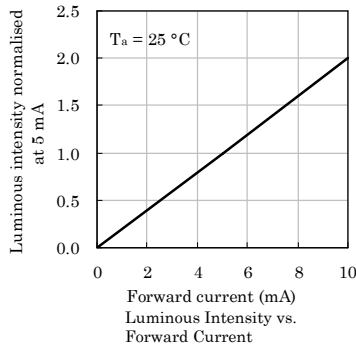
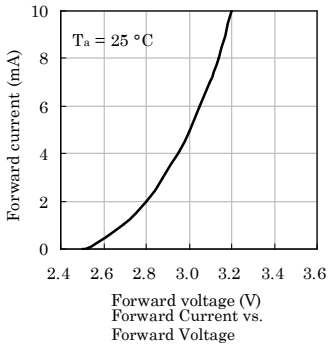

❖ Blue

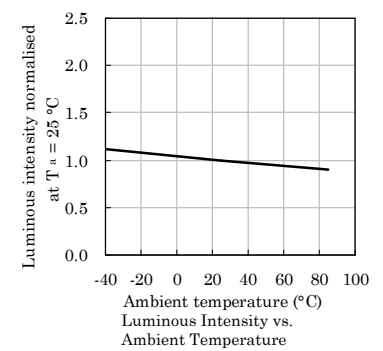
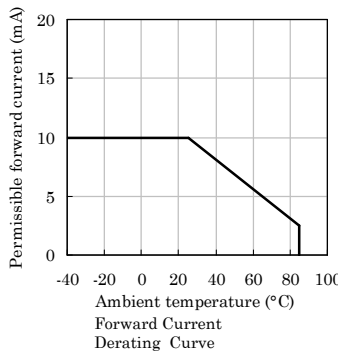
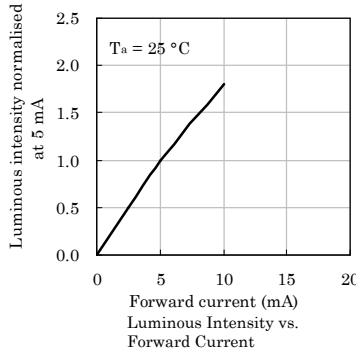
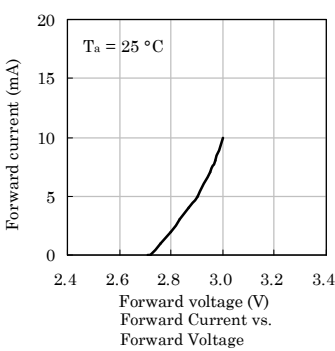

❖ Red

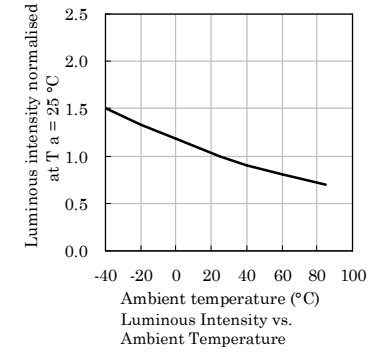
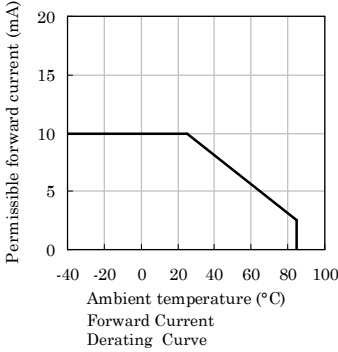
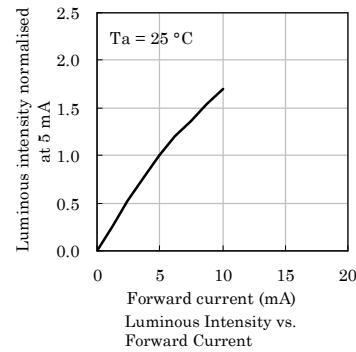
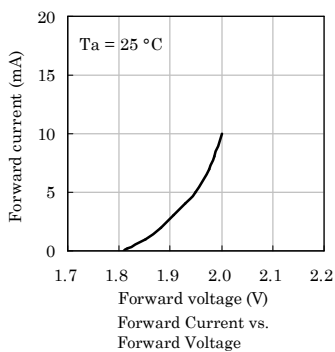

❖ LED is recommended for reflow soldering and soldering profile is shown below.

❖ The device has a single mounting surface. The device must be mounted according to the specifications.

Reflow Soldering Profile for SMD Products (Pb-Free Components)

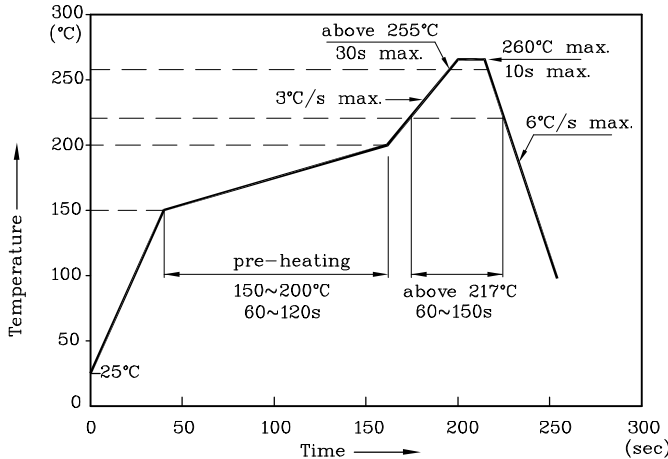

Notes:

1. All temperatures refer to the center of the package, measured on the package body surface facing up during reflow.
2. Do not apply any stress to the LED during high temperature conditions.
3. Maximum number of soldering passes: 2

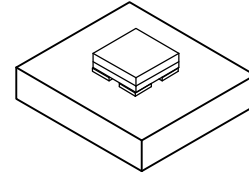

❖ Recommended Soldering Pattern (Units : mm; Tolerance: ± 0.1)

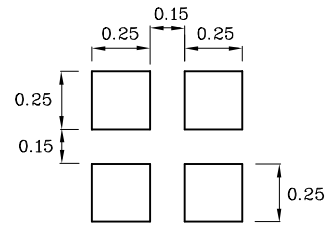

Mask open area ratio: 80%
Mask thickness: 80~100um

❖ Tape Specification (Units : mm)

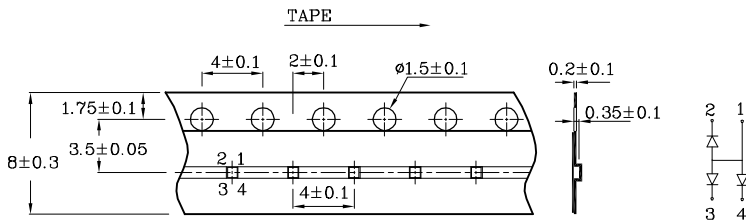

❖ Reel Dimension (Units : mm)

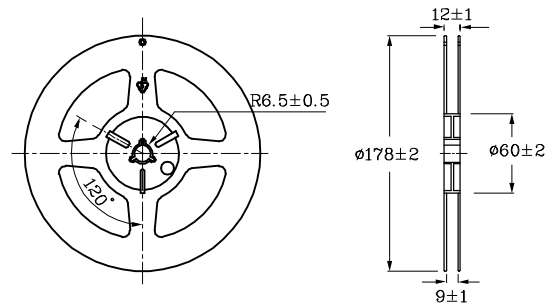

Remarks:

If special sorting is required (e.g. binning based on forward voltage, Luminous intensity / luminous flux, or wavelength), the typical accuracy of the sorting process is as follows:

1. Wavelength: +/-1nm
2. Luminous intensity / luminous flux: +/-15%
3. Forward Voltage: +/-0.1V
4. Within 35mW when multiple chips are lightened
5. The maximum ratings are valid for the case of lighting a single chip

When two chips are lit at the same time, each chip should be driven at a current lower than 50% of the absolute maximum ratings

When three chips are lit at the same time, each chip should be driven at a current lower than 30% of the absolute maximum ratings

6. Duty Cycle ≤ 1/20, Pulse Width = 1ms.

Note: Accuracy may depend on the sorting parameters.

PACKING & LABEL SPECIFICATIONS

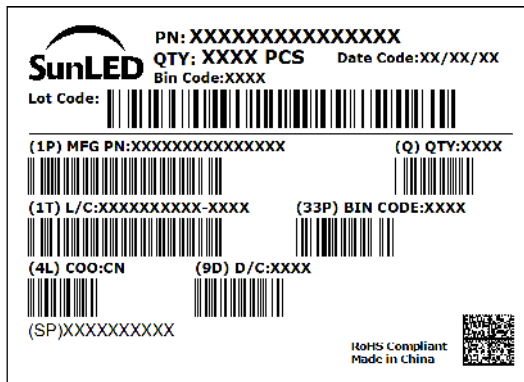
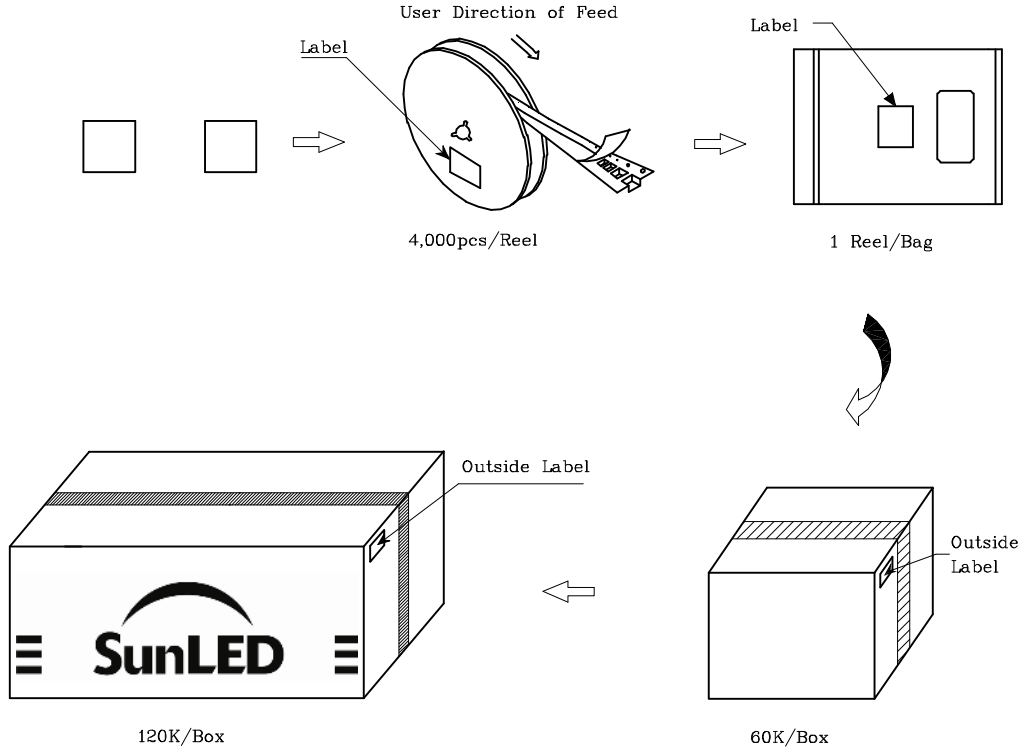

TERMS OF USE

1. Data presented in this document reflect statistical figures and should be treated as technical reference only.
2. Contents within this document are subject to improvement and enhancement changes without notice.
3. The product(s) in this document are designed to be operated within the electrical and environmental specifications indicated on the datasheet. User accepts full risk and responsibility when operating the product(s) beyond their intended specifications.
4. The product(s) described in this document are intended for electronic applications in which a person's life is not reliant upon the LED. Please consult with a SunLED representative for special applications where the LED may have a direct impact on a person's life.
5. The contents within this document may not be altered without prior consent by SunLED.
6. Additional technical notes are available at <https://www.SunLEDusa.com/TechnicalNotes.asp>