

B45196H, Tantalum, MnO2 Tantalum, 47 uF, 10%, 10 V, SMD, Molded, 1.4 Ohms, 6032, Height Max = 2.8mm

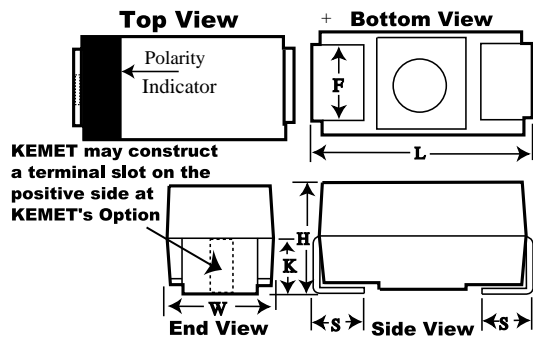

General Information	
Supplier:	KEMET
Series:	B45196H
Dielectric:	MnO2 Tantalum
Style:	SMD Chip
Description:	SMD, Molded
Features:	Automotive
RoHS:	Yes
Termination:	Tin
Notes:	Obsolete

Dimensions	
Footprint	6032
L	6mm +/-0.3mm
W	3.2mm +/-0.3mm
H	2.5mm +/-0.3mm
S	1.3mm +/-0.3mm
F	2.2mm +/-0.1mm
K	1.8mm TYP

Packaging Specifications	
Packaging:	T&R, 178mm
Packaging Quantity:	750

Specifications	
Capacitance:	47 uF
Capacitance Tolerance:	10%
Voltage DC:	10 VDC (85C), 6.7 VDC (125C)
Temperature Range:	-55/+125C
Rated Temperature:	85C
Dissipation Factor:	6%
Failure Rate:	N/A
Resistance:	1.4 Ohms (100kHz)
Current:	280.3 mAmps (25C), 252.3 mAmps (85C), 112.1 mAmps (125C)
Leakage Current:	4.7 uA