

SEZ. A-A

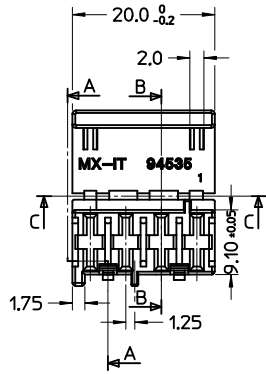

SEZ. B-B

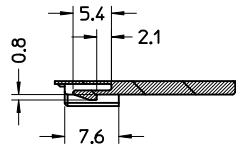
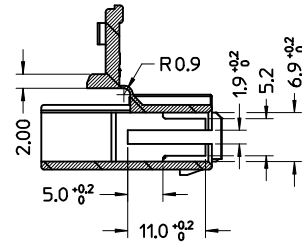

SEZ. C-C

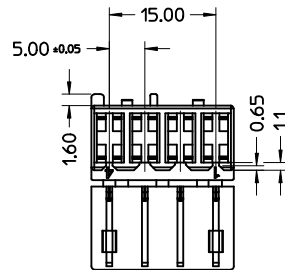
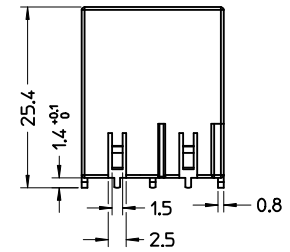
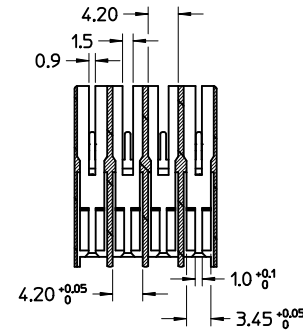
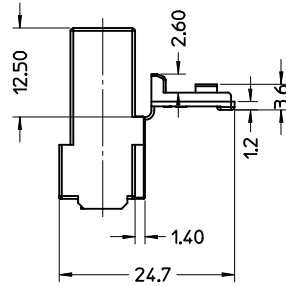
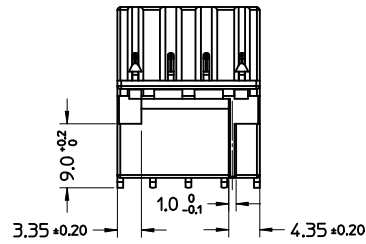
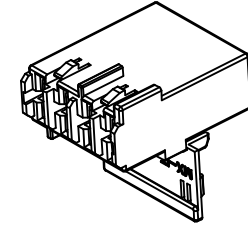
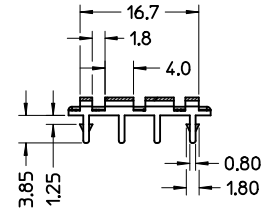

MATERIALE: NYLON 6.6 V2 NATURALE (GWT 850 °C)

MATERIAL: NYLON 6.6 V2 NATURAL (GWT 850 °C)

IMBALLO: BOX CON SACCHETTO DI NYLON

PACKAGING: BOX WITH PLASTIC BAG

SPQ: 4000 pz.

Std.Descr: \*HOUSINGW/SEC LOCK 4 CKT\*

EC NO: Z2002-0147 DRWN:FGOTTARD/2002/03/08 CHKD:MTSTAG/2002/03/08 APPR:GZUIN 2002/03/08	DESCRIPTION REV B	QUALITY SYMBOLS ▽ - 0 ▽ - 0	GENERAL TOLERANCES (UNLESS SPECIFIED) mm INCH	SCALE 2:1 DESIGN UNITS METRIC DIMENSION STYLE MM ONLY	FIRST ANGLE PROJECTION REVISE ON CAD ONLY
		4 PLACES ± --- ± --- 3 PLACES ± --- ± --- 2 PLACES ± 0.10 ± --- 1 PLACE ± 0.2 ± ---	DRAWN BY FGOTTARD DATE 1999/07/28	TITLE HOUSING 4 CKT RAST 5	
		ANGULAR ± 2 ° DRAFT WHERE APPLICABLE MUST REMAIN WITHIN DIMENSIONS	CHECKED BY MTSTAGU DATE 1999/07/28	MATERIAL NO. 94535-7004 DOCUMENT NO. SD-94535-005	
		SHEET NO. 1 OF 1			

THIS DRAWING CONTAINS INFORMATION THAT IS PROPRIETARY TO MOLEX INCORPORATED AND SHOULD NOT BE USED WITHOUT WRITTEN PERMISSION