

INSTRUCTION SHEET

Communication Unit Supporting Scanner

Confirm that the delivered product is what you have ordered. Read this instruction sheet to make sure of correct operation. Make sure that the instruction sheet is kept by the end user.

SAFETY PRECAUTIONS

In this operation instruction sheet, safety precautions are categorized in order of importance to Warning and Caution:

WARNING

Warning, notice are used to emphasize that improper may cause severe personal injury or death.

CAUTION

Caution notices are used where inattention might cause personal injury or damage to equipment.

WARNING

This product is not designed for use in medical equipment, nuclear power, railways, aircraft, passenger vehicle equipment, or similar applications requiring a high degree of reliability and safety. Do not use the product for these applications.

When using this product in a system that may impact human life, such as in the management of chemicals, take the utmost care with a redundant design and safety design so that there is no possibility of impacting human life when data is mistaken.

Do not modify, disassemble, or repair this product. There is a risk of serious accidents such as electric shock, damage, fire, malfunction, and other leave accident.

This product is for general electronic equipment. Do not use it for applications where there is a direct threat to the body or to human life due to malfunction or failure.

Always turn off the power supply before wiring, maintaining, and inspecting the product. Otherwise there is a risk of electric shock or failure.

CAUTION

Do not connect the product to a power supply outside the rated power supply voltage range or to an AC power supply. Otherwise there is a risk of explosion or burnout. Mistakenly wiring the product may cause the internal circuit to be damaged. Wiring the input and output circuits by referring to "Wiring, I/O's Information" in article 7.

Avoid parallel wiring of the product's wires in the same conduit or duct with high voltage lines or power lines (inverter power lines in particular) as this may cause malfunction or damage due to the effect of induction noise.

If the wires are long and when there is a risk of being affected by power sources or solenoids, independently wire the product as a general rule.

Avoid installing or using the product in the following locations as there is a risk of malfunction or damage.

- 1) Near induction equipment or heat sources
- 2) Locations with many vibrations or shocks
- 3) Dusty and dirty locations
- 4) In an atmosphere with hazardous gases such as sulfidizing gas
- 5) Locations in direct contact with water, oils, or chemicals
- 6) Outdoors

This product is not an explosion-proof product. Confirm that explosion-proof capabilities are not required when installing the product.

EU Authorized Representative:

IDEC Elektrotechnik GmbH
Heseltuecken 8, 22453 Hamburg, Germany

Manufacturer:
IDEC CORPORATION
2-6-64, Nishimiyahara, Yodogawa-ku,
Osaka 532-0004, Japan

Installing the driver

Using the USB port
To use the USB interface, you must install the dedicated Active USB-COM port drive (virtual COM port driver) on the host computer. For details on the installation procedure, refer to the unit manual.

The unit manual can be downloaded from the dedicated site on the IDEC website. If using this product in an environment where the IDEC homepage cannot be accessed, please contact IDEC sales representatives.

1 Type number

WB9Z-CU100

2 General specifications

Power source for scanner	-	5VDC
--------------------------	---	------

Environmental Specifications	Ambient usage temperature	0 to +50°C (no freezing)
	Ambient storage temperature	-20 to +60°C (no freezing)
	Ambient usage humidity	30 to 85%RH (no condensation)
	Vibration Resistance	10 to 55Hz, Double amplitude: 0.3mm
Protective construction		IP20
Electrical Specifications	Rated Operating Voltage *1	External power supply : 24VDC +10%, -20% (including ripple) or PoE (Alternative A / B) *5
	Consumption Current	700mA max.
	Input	180g approx.
	Input Type	2 circuits in 1 common line (IN_0, 1)
Output Specifications	Rated input voltage	Bidirectional Voltage Input
	Input threshold voltage (ON)	24VDC (28.8V max.)
	OFF Current	15VDC
	Output	1.3mA max.
Output Specifications	Output Type	4 circuits (OUT_0, 1, 2, 3)
	Rated load	Semiconductor Relay Output
	Leakage current at OFF	24VDC (30VDC max., 100mA max.)
	Voltage drop	0.1mA max.
Communication Ports	Scanner interface	1V max.
	Ethernet Port*4	RS-232 (600-115,200bps) *3 IEEE802.3 compliant *2 10BASE-T/100BASE-TX
	Terminal	Communication Protocol: TCP/IP (Server)
	USB interface (for maintenance only)	Cable length: 100m max. Use a shielded cable, when using a cable of 30m long or more. RS-232(600-115,200bps) *2 Cable length: 10m max. RS-422(full duplex) (600-115,200bps) *2 Cable length: 500m max. *6 USB2.0(Full-speed)
Certified standards		12Mbps(Virtual COM)
		UL/c-UL Listing *1 CE marking(Declaration of Conformity), VCCI(Report of Compliance),FCC(Verification), ICES-003(Comply)

*1 If you use this product as UL Listing product, you shall use only a Listed Power Supply with an output rated maximum 24V dc, 8A, 100VA and marked LPS or NEC Class 2.
*2 Ethernet, RS-232, and RS-422 are mutually exclusive, only one of three can be used at the same time.
*3 Default setting (Scanner interface) : Baud rate 9,600bps, data size 8bit, 1 stop bit, even parity bit, no flow control
*4 Default setting: Port No. 3000, IP address 192.168.1.100, subnet mask 255.255.255.0
*5 The PoE input is intended for intra-building use only.
*6 And the PoE is set Class 0. The power consumption can be changed with which scanner to use.
*6 When using a cable of 30m long or more, use a shielded cable and connect the shield to F.E.

3 Designation

Pin number	Signal name	Function
1	VBUS	Bus power
2	D-	Data-
3	D+	Data+
4	ID	Maintenance
5	GND	Ground

Do not use an On-The-Go cable. The ID pin is used internal circuit for maintenance.

FE connection Switch

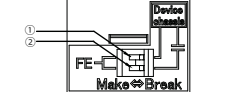

① Make	① Break
② Make Direct Connection	② Capacitive Coupling
③ Break	③ No-Connection

You can change the connection F.E. to Scanner Device chassis (actually DIN connector shell).
*CE marking, EMC directive, is self-declared under default setting (direct connection).

PIN assign of DIN Connector to Scanner

① Out_0	Outputs from Scanner
② Out_1	(NPN open Collector)
③ Out_2	
④ Out_3	
⑤ 5VDC	P.S. for scanner (+V)
⑥ S_RD	Scanner Receive data (RS-232)
⑦ In_0	Inputs to Scanner
⑧ In_1	
⑨ 0V	P.S. for scanner (-V, combined SG)
⑩ S_SD	Scanner Transmission data (RS-232)
⑪ S_RS	RS-232
⑫ S_CS	Control signal
⑬ 0V	P.S. for scanner (-V, combined SG)

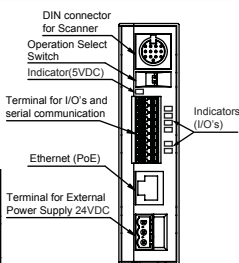

PIN assign of Terminal for I/O's, and serial communication

SDA(RS-422)	OUT_COM
SDB(RS-422)	OUT_0
RDA(RS-422)	OUT_1
RDB(RS-422)	OUT_2
SG(RS-232)	OUT_3
RD(RS-232)	IN_COM
SD(RS-232)	IN_0
CS(RS-232)	IN_1
RS(RS-232)	NC

PIN assign of Terminal for External Power supply

24VDC	
0V	
F.E.	*You shall connect to F.E., even if you use PoE.

Operation Select Switch (Ethernet)

SW1 OFF	SW1 ON
Normal Operation *Default	Stopping Ethernet
SW2 OFF	SW2 ON
Running under default setting	Do not use (for maintenance)

You can change the operation by turning ON P.S. after SW1 and SW2 are set.

4 Mounting

Mounting on DIN Rail
Use a 35mm wide DIN Rail.

- (1) Put the groove of this product on the DIN Rail.
- (2) Press this product towards the DIN Rail.

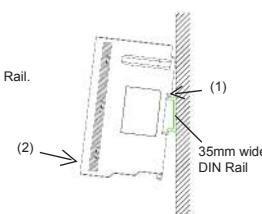

Direct Mounting on Panel Surface

- (1) Pull out the DIN Rail Cramp.

- (2) Attach this product to the mounting plate using the screw holes.

- (3) Attach this product to the mounting plate using two M3 tapping screws.

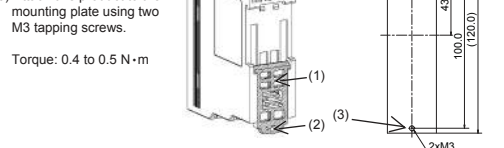

5 Mounting direction

To allow for heat dissipation and facilitate replacement, ensure that there are at least minimum distance between the WB9Z and surrounding equipments. See as follows.

Correct Mounting

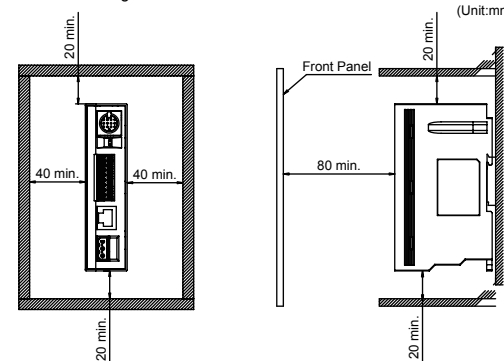

Incorrect Mounting Direction



7 Dimension

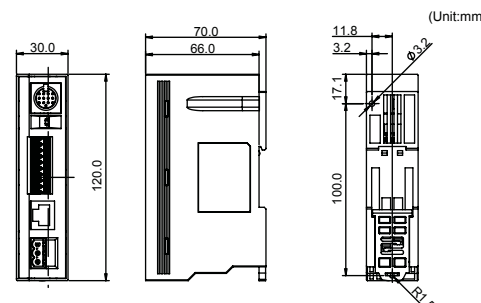

7 Wiring, I/O's Information

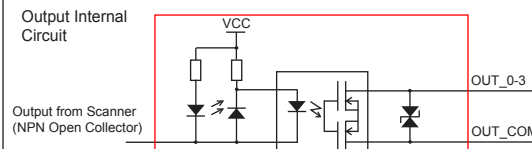
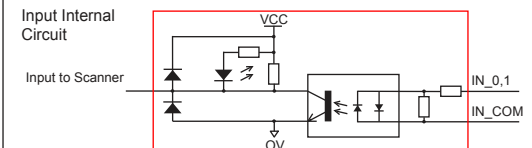

8 Wiring, terminal Information

Use applicable cables for wiring and recommended ferrules (manufactured by Phoenix Contact) as follows:

Terminal for External Power Supply	Plug Connector	FRONT-MSTB 2,5/3-ST-5,08 (PHOENIX CONTACT) Use the recommended driver : SZS 0,6X3,5 (PHOENIX CONTACT)
	Applicable Wire Gauge	0.25 to 2.5mm ² (AWG12-24)
	Recommended Ferrule*1	AI 0,25-10YE, AI 0,34-10 TQ, AI 0,5-10 WH, AI 0,75-10 GY, AI1-10 RD, AI1,5-10 BK, AI2,5-10 BU AI-TWIN 2X 0,5-10 WH, AI-TWIN 2X 0,75-10 GY AI-TWIN 2X 1,0-10 RD, AI-TWIN 2X 1,5-10BK (PHOENIX CONTACT)
	Tightening Torque	0.5 to 0.6 N·m
Terminal for I/O's and Serial communication	Plug Connector	DFMC 1,5/ 9-ST-3,5 (PHOENIX CONTACT) Use the recommended driver : SZS 0,4X2,5 VDE (PHOENIX CONTACT)
	Applicable Wire Gauge	0.25 to 0.75mm ² (AWG16-24)
	Recommended Ferrule*1	AI 0,25-10 YE, AI 0,34-10 TQ, AI 0,5-10 WH, AI 0,75-10 GY (PHOENIX CONTACT)

*1 Use designated tool by PHOENIX CONTACT when crimping ferrules. Part No. : CRIMPFOX6

9 Precautions when discarding the product

When discarding the product, handle it as industrial waste.

10 Other important information

If you use this product as UL Listing product, you shall use only with UL Listed I.T.E.

FCC Regulations

This device complies with Part 15 of the FCC Rules. Operation is subject to the following two conditions:

- (1) This device may not cause harmful interference, and
- (2) this device must accept any interference received, including interference that may cause undesired operation.

NOTE: This equipment has been tested and found to comply with the limits for a Class B digital device, pursuant to Part 15 of the FCC Rules. These limits are designed to provide reasonable protection against harmful interference in a residential installation. This equipment generates, uses and can radiate radio frequency energy and, if not installed and used in accordance with the instructions, may cause harmful interference to radio communications. However, there is no guarantee that interference will not occur in a particular installation. If this equipment does cause harmful interference to radio or television reception, which can be determined by turning the equipment off and on, the user is encouraged to try to correct the interference by one or more of the following measures:

- Reorient or relocate the receiving antenna.
- Increase the separation between the equipment and receiver.
- Connect the equipment into an outlet on a circuit different from that to which the receiver is connected.
- Consult the dealer or an experienced radio/TV technician for help.

Canadian Department of Communications Compliance Statement

• CAN ICES-3(B) / NMB-3(B)