



YETDA INDUSTRY LTD.

Technical Data Sheet

MODEL NO : Q150YUS4

1206Package 3.2*1.6mm Chip LEDs

Features :

- Package in 8mm tape on 7" diameter reel
- Compatible with automatic placement equipment
- Compatible with reflow solder process

Applications :

- Indicators
- Automotive : backlighting in dashboard and switch
- Backlight for LCD

Die material	Emitted color	Lens Color
Clear AlGaInP IIOWater	Ye	

Electrical / Optical Characteristics (Ta=25°C)

Parameter	Symbol	Condition	Min	Typ.	Max	Unit
Luminous Intensity	Iv	IF=20mA		150		md
Dominant Wavelength	λ_D	IF=20mA		590		nm
Peak Emission Wavelength	λ_p	IF=20mA		595		nm
Viewing Angle	2 θ 1/2	IF=20mA		130		Deg
Forward Voltage	Vf	IF=20mA		2.0	2.4	V
Reverse Current	IR	VR=5V			10	μ A

Absolute Maximum Ratings (Ta=25°C)

Parameter	Symbol	Maximum	Unit
Power Dissipation	Pd	78	mW
Peak Forward Current (1/10 Duty Cycle 0.1ms Pulse Width)	IF (Peak)	100	mA
Continuous Forward Current	IF	30	mA
Reverse Voltage	VR	5	V
Derating Linear From 25°C		0.3	mW/°C
Operating Temperature Range	Topr	-30 to +80	°C
Storage Temperature Range	Tstg	-40 to +90	°C

20090727



YETDA INDUSTRY LTD.

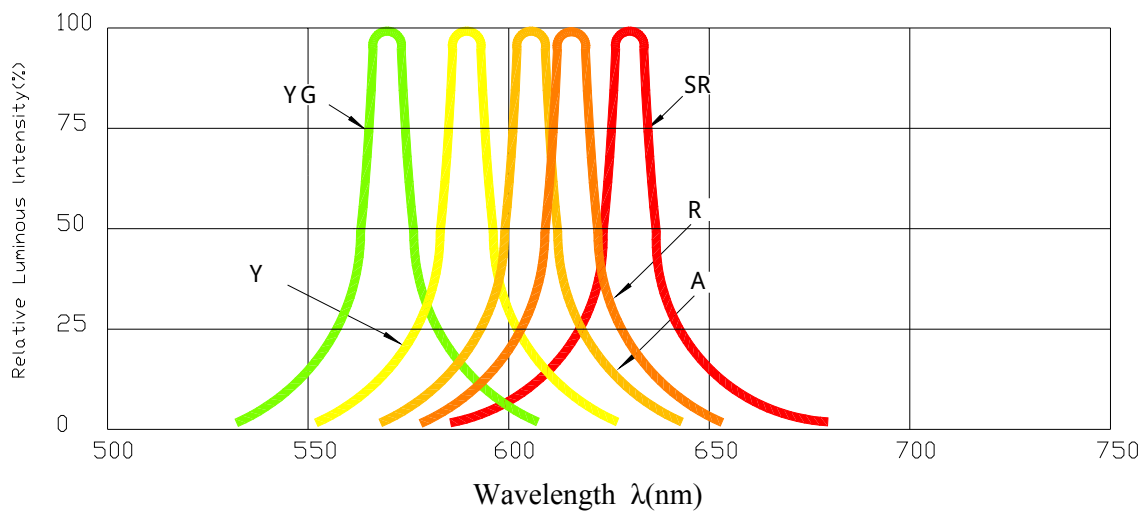

Forward Current Vs. Forward Voltage
 $T_a=25^\circ\text{C}$

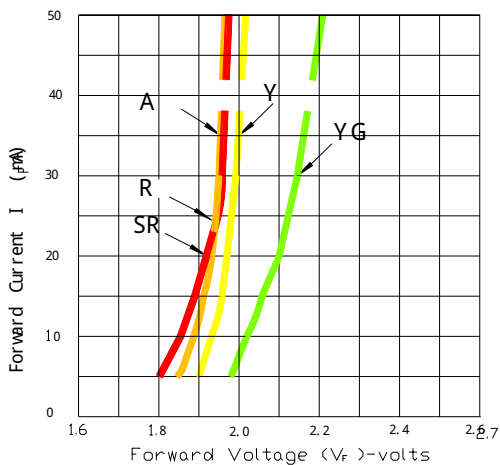

Forward Current Derating Curve

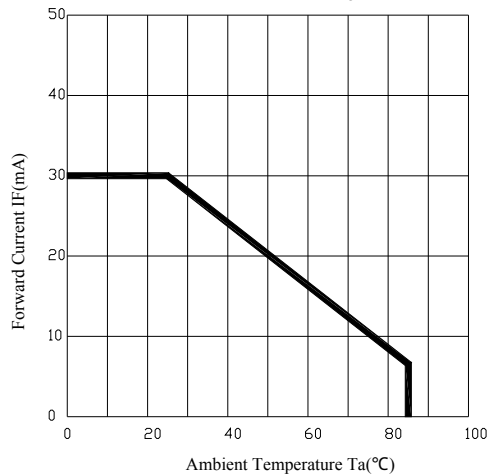

Luminous Intensity Vs. Forward Current
 $T_a=25^\circ\text{C}$

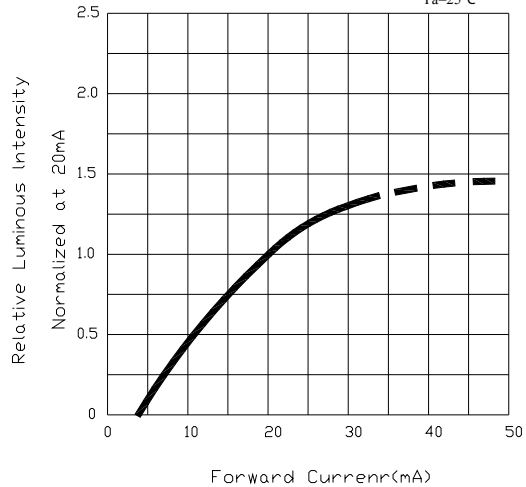

Radiation Diagram
 $T_a=25^\circ\text{C}$

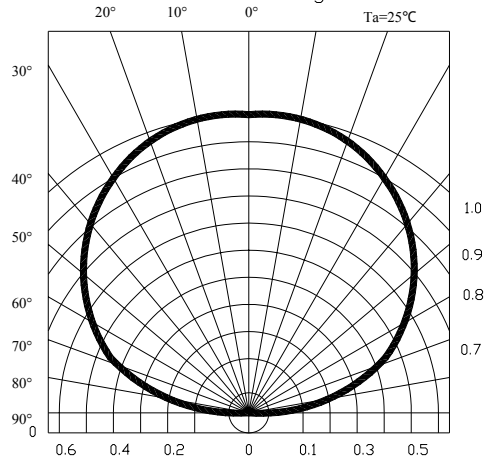



YETDA INDUSTRY LTD.

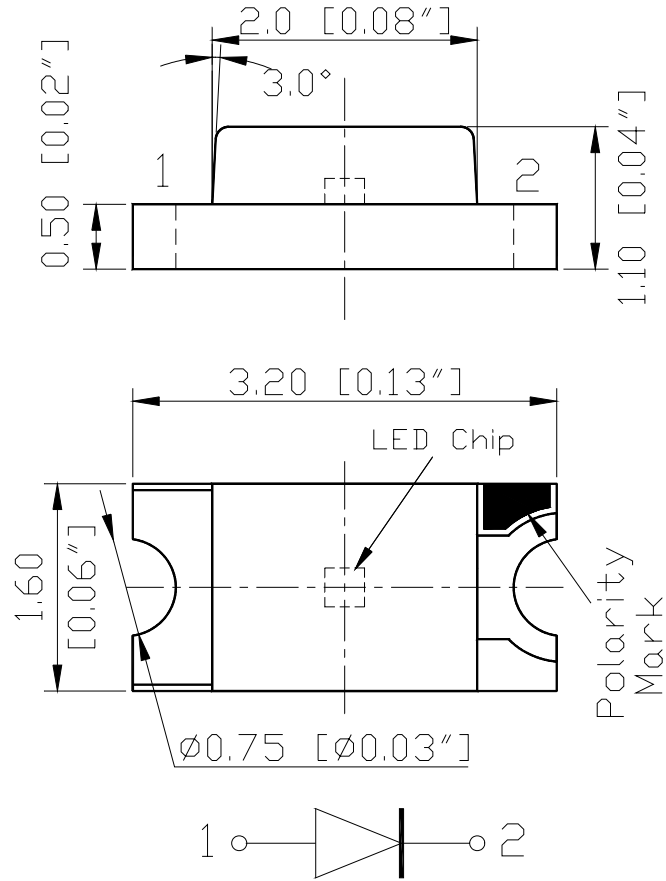

RECOMMEND PAD LAYOUT

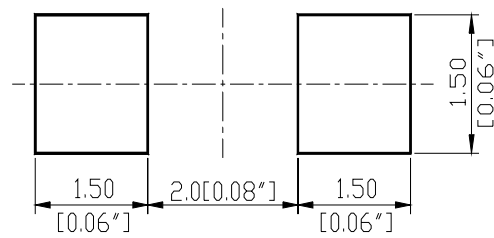



YETDA INDUSTRY LTD.

Descriptions :

- The Chip-LED Taping is much smaller than lead frame type components, thus enable smaller board size, higher packing density, reduced storage space and finally smaller equipment to be obtained.
- Besides, lightweight makes them ideal for miniature application, etc.

● Soldering heat reliability (DIP):

Please refer to the following figure :

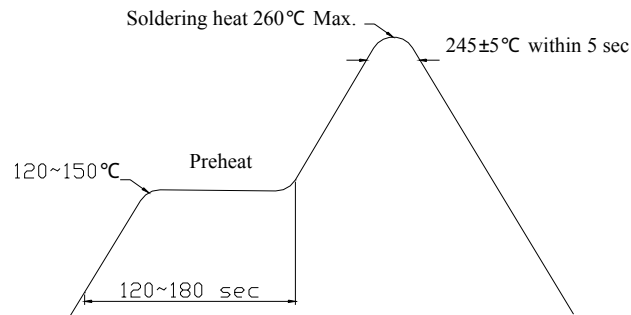

● Precautions For Use :

- Over- current- proof

Customer must apply resistors for protection, otherwise slight voltage shift will cause big current change (Burn out will happen)

- Storage

1. The operation of temperature and R.H. are : 5°C ~ 30°C, 60%R.H. Max..
2. Once the package is opened, the products should be used within a week. Otherwise, they should be kept in a dampproof box with desiccating reagent. Considering the tape life, we suggest our customers to use our products within 1.5 year (from production date) .
3. It's recommended to bake before soldering when the package is unsealed after 72 hrs. The condition is : 60°C±5°C for 15hrs.



● **Test Circuit**

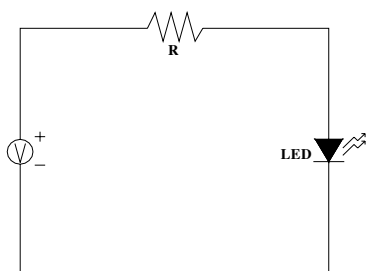

● **Reflow Temp. / Time :**

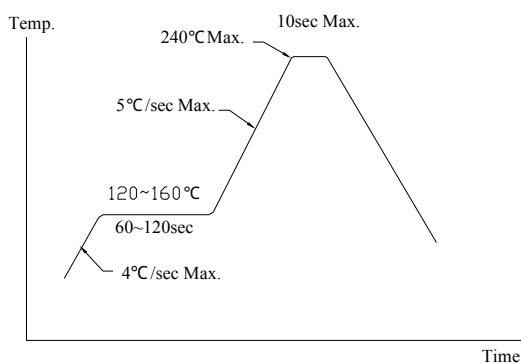

● **Reliability Test Items And Conditions**

The reliability of products shall be satisfied with items listed below.

No.	Items	Test Condition	Test Hours/Cycles	Sample Size
1	Solder Heat	TEMP : 260°C±5°C	5 sec	48 pcs
2	Temperature Cycle	90°C~ 25°C~ -30°C ~ 25°C 30m 5m 30m 5m	300Cycles	48 Pcs
3	Thermal Shick	100°C~ -55°C 10m 10m	100Cycles	48 Pcs
4	Operation Life	If=20mA	1000 Hrs	48 Pcs
5	High Temperature Storage	Temp:90°C	1000Hrs	48 Pcs
6	Low Temperature Storage	Temp:-30°C	1000Hrs	48 Pcs
7	High Temperature/High Humidity	80°C / R.H80%	1000Hrs	48 Pcs