

NJM386

The NJM386 is a power amplifier designed for use in low voltage consumer applications. The gain is internally set to 20 to keep external part count low, but the addition of an external resistor and capacitor between pins 1 and 8 will increase the gain to any value up to 200.

The inputs are ground reference while the output is automatically biased to one half the supply voltage. The quiescent power drain is only 24 milliwatts when operating from a 6 volt supply, making the NJM386 ideal for battery operation.

Package Outline

Absolute Maximum Ratings (Ta=25°C)

Supply Voltage	V+	15V
Power Dissipation	P <sub>D</sub> (D-Type)	700mW
	(L-Type)	700mW
	(M.E-Type)	300mW
Input Voltage Range	V <sub>IN</sub>	±0.4V
Operating Temperature Range	T <sub>opr</sub>	-20~+70°C
Storage Temperature Range	T <sub>stg</sub>	-40~+125°C

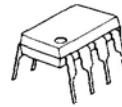

NJM386D



NJM386M

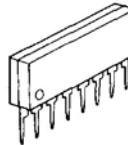

NJM386L



NJM386E

Features

- Battery operation
- Minimum external parts
- Wide supply voltage range 4-12 Volt
- Low quiescent current drain 4mA
- Voltage gains from 20 to 200
- Ground referenced input
- Self-centering output quiescent voltage
- Low distortion
- Eight pin dual-in-line package/Nine pin single-in-line package

Applications

- AM-FM radio amplifiers
- Portable tape player amplifiers
- Intercoms
- TV sound systems
- Line drivers
- Ultrasonic drivers
- Small servo drivers
- Power converters

5

Equivalent Circuit

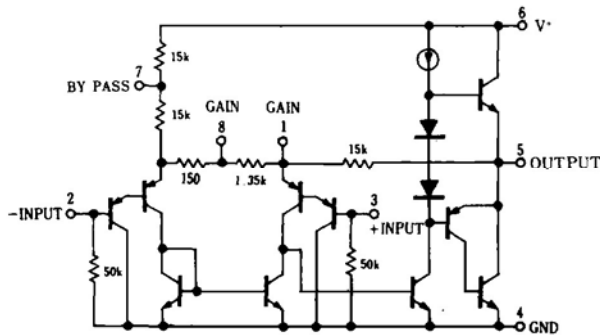

(note) please inquire to the agent of NJRC in regard to M-Type description.

Connection Diagram

D,M,E-Type  
(Top View)

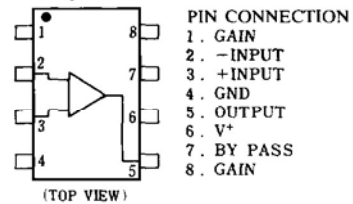

L-Type

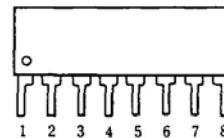

## ■ Electrical Characteristics (Ta=25°C)

Parameter	Symbol	Test Condition	Min.	Typ.	Max.	Unit
Operating Supply Voltage	V <sup>+</sup>		4	—	12	V
Supply Current	I <sub>CC</sub>	V <sup>+</sup> =6V, V <sub>IN</sub> =0	—	3	8	mA
Output Power (note 2)	P <sub>o</sub>	V <sup>+</sup> =6V, R <sub>L</sub> =8Ω, THD=10%	250	325	—	mW
		V <sup>+</sup> =9V, R <sub>L</sub> =16Ω, THD=10%	—	500	—	mW
Voltage Gain	A <sub>v</sub>	V <sup>+</sup> =6V, f=1kHz	24	26	28	dB
		10μF from Pin 1 to 8	43	46	49	dB
Bandwidth	BW	V <sup>+</sup> =6V, Pins 1 and 8 Open	—	300	—	kHz
Total Harmonic Distortion	THD	V <sup>+</sup> =6V, R <sub>L</sub> =8Ω, P <sub>OUT</sub> =125mW	—	0.2	—	%
		f=1kHz, Pins 1 and 8 open	—	—	—	—
Power Supply Rejection Ratio	SVR	V <sup>+</sup> =6V, f=1kHz, C <sub>BYPASS</sub> =10μF Pins 1 and 8 Open	—	50	—	dB
Input Resistance	R <sub>IN</sub>		—	50	—	kΩ
Input Bias Current	I <sub>B</sub>	V <sup>+</sup> =6V, Pins 2 and 3 Open	—	250	—	nA

(note 1) Set the maximum junction temperature to 125°C and reduce the thermal resistance to 143°C/W when the ambient temperature is high.

(note 2) Insert a 10Ω resistor and an 0.05μF capacitor in series to the ground terminal from pin 5.

## ■ Typical Application

5

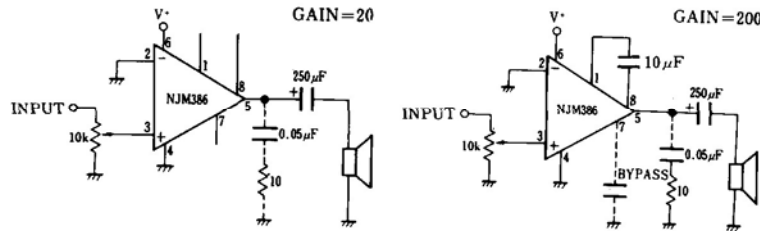

## ■ Power Dissipation vs. Ambient Temperature

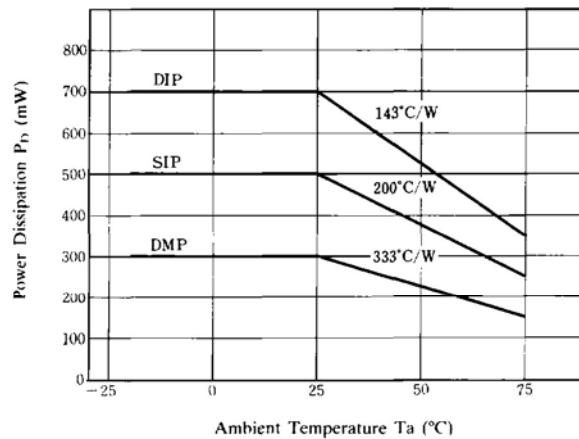

## ■ Typical Applications

### Amplifier with Bass Boost

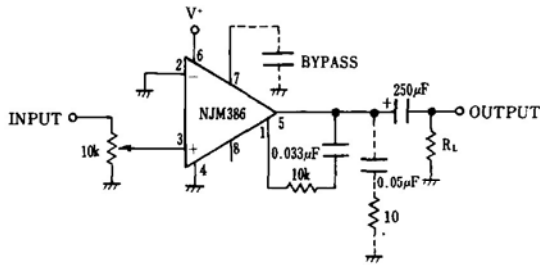

### Low Distortion Power Wienbrige Oscillator

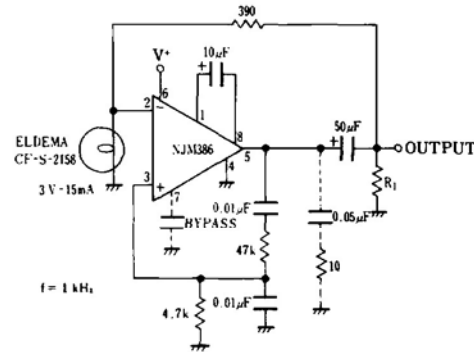

### Amplifier 2

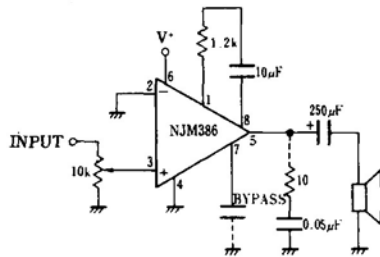

### Square Wave Oscillator

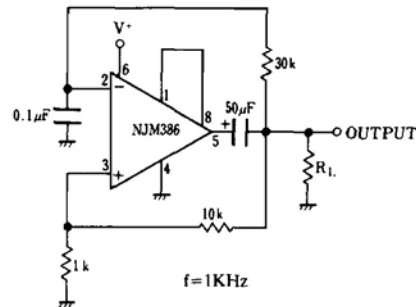

## Application Hints

### GAIN CONTROL

To make the NJM386 a more versatile amplifier, two pins (1 and 8) are provided for gain control. With pins 1 and 8 open the 1.35kΩ resistor sets the gain at 20 (26dB). If a capacitor is put from pin 1 to 8, bypassing the 1.35kΩ resistor, the gain will go up to 200 (46 dB). If a resistor is placed in series with the capacitor, the gain can be set to any value from 20 to 200. Gain control can also be done by capacitively coupling a resistor (or FET) from pin 1 to ground.

Additional external components can be placed in parallel with the internal feedback resistors to tailor the gain and frequency response for individual applications. For example, we can compensate poor speaker bass response by frequency shaping the feedback path. This is done with a series RC from pin 1 to 5 (paralleling the internal 15 kΩ resistor). For 6 dB effective bass boost:  $R \cong 15k\Omega$ , the lowest value for good stable operation is  $R_{MIN} = 10k\Omega$  if pin 8 is open. If pins 1 and 8 are bypassed then R as low as 2kΩ can be used. This restriction is because the amplifier is only compensated for closed-loop gains greater than 9.

### INPUT BIASING

The schematic shows that both inputs are biased to ground with a 50kΩ resistor. The base current of the input transistors is about 250 nA, so the inputs are at about 12.5 mV when left open. If the dc source resistance driving the NJM386 is higher than 250kΩ it will contribute very little additional offset (about 2.5 mV at the input, 50 mV at the output). If the dc source resistance is less than 10kΩ, then shorting the unused input to ground will keep the offset low (about 2.5 mV at the input, 50 mV at the output). For dc source resistances between these values we can eliminate excess offset by putting a resistor from the unused input to ground, equal in value to the dc source resistance. Of course all offset problems are eliminated if the input is capacitively coupled.

When using the NJM386 will higher gains (bypassing the 1.35 kΩ resistor between pins 1 and 8) it is necessary to bypass the unused input, preventing degradation of gain and possible instabilities. This is done with a 0.1μF capacitor or a short to ground depending on the dc source resistance on the driven input.

# 5

■ Typical Characteristics (Ta=25°C)

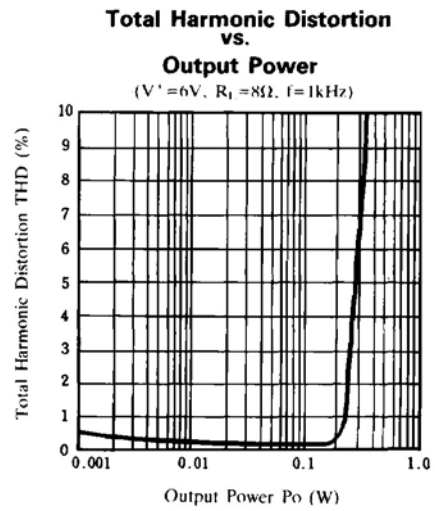
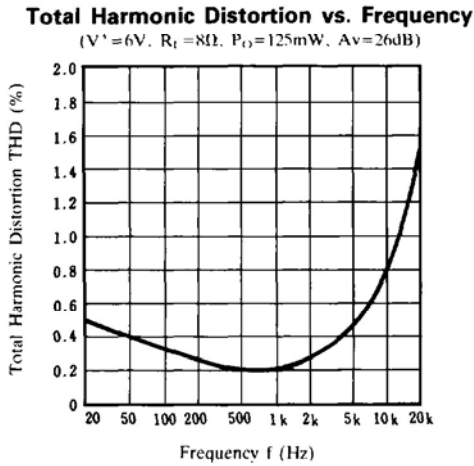
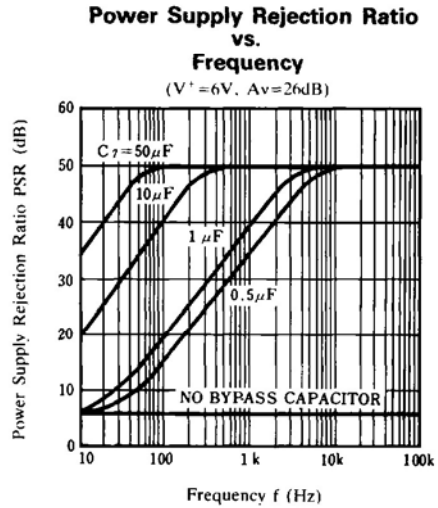
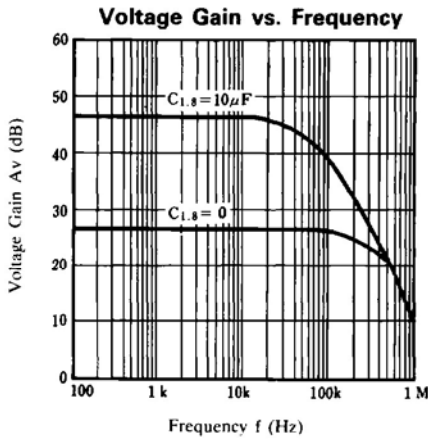
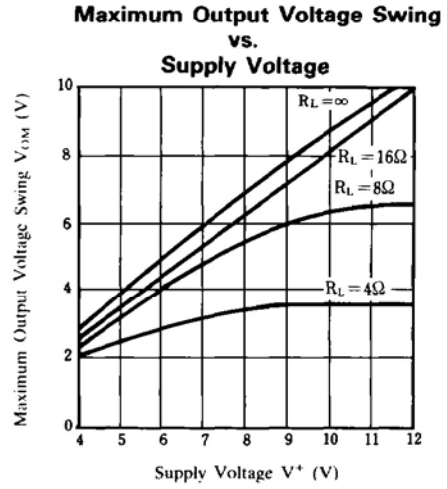
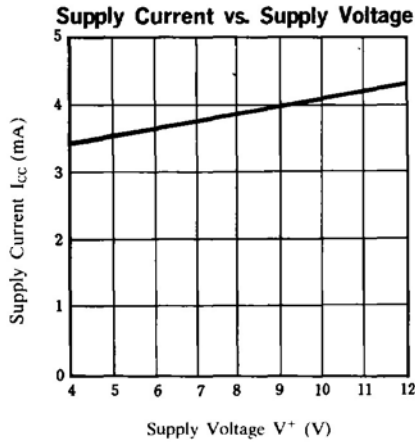

5

■ Typical Characteristics (Ta=25°C)

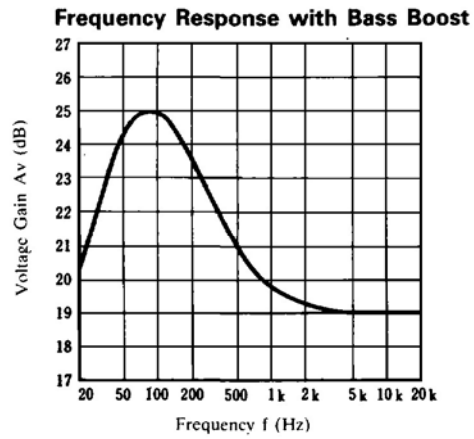
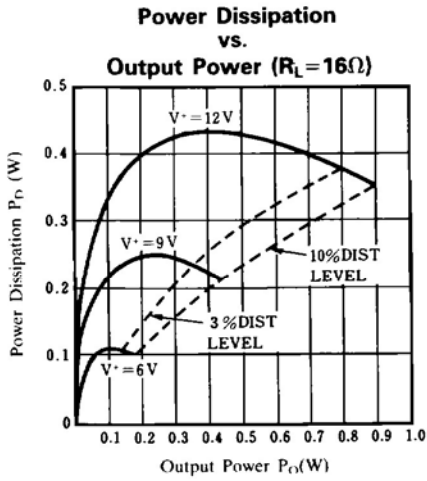
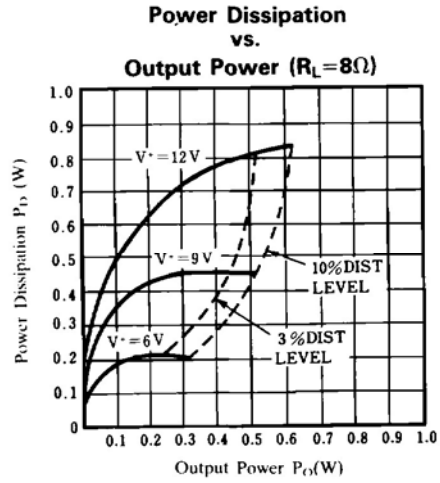
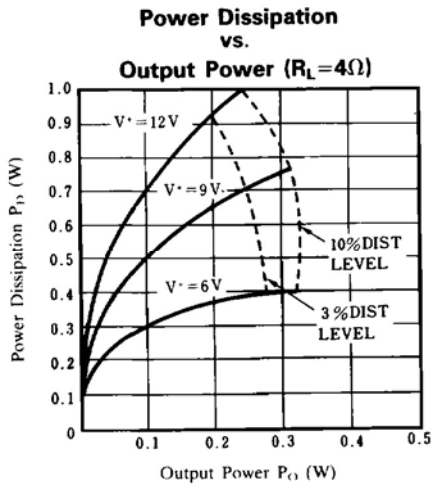

5

(In regard to Test Circuit.  
 Please refer to  
 Typical Application  
 "Amplifier with Bass Boost")