

# RIGHT ANGLED PLUG WITH LED

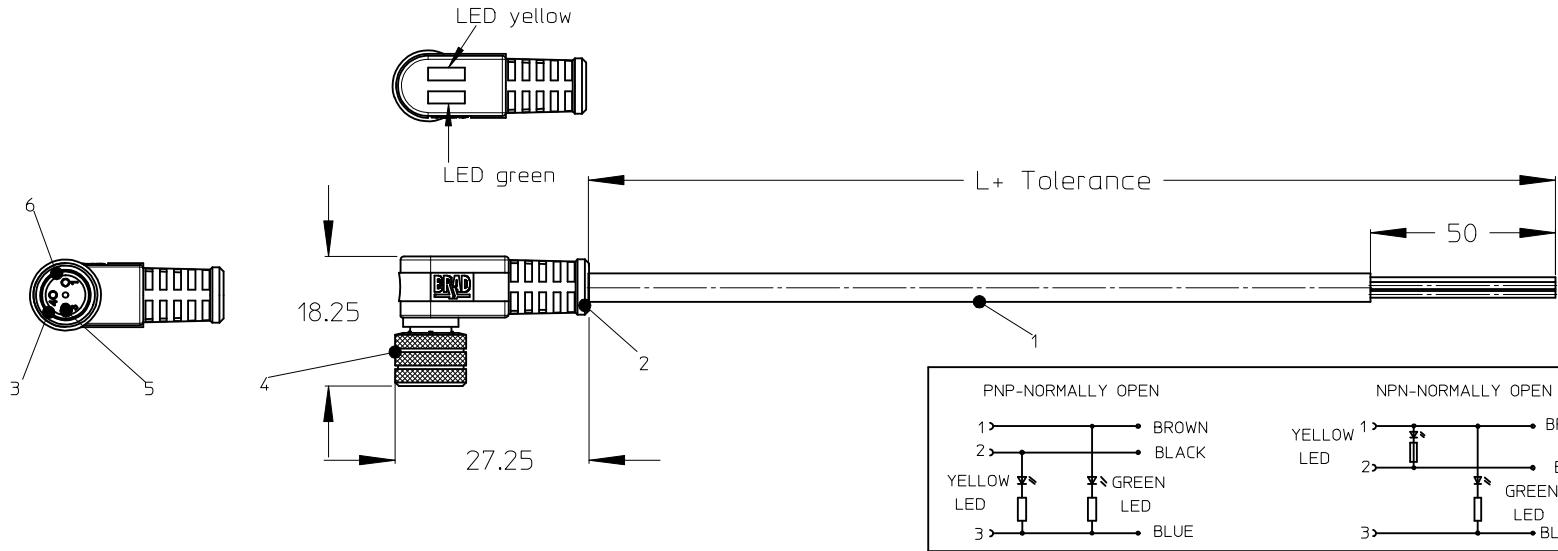

**NOTES:**

Temperatur Range -25°C/+80°C  
 Contact Current Rating 3A  
 Voltage Rating 3 poles max. 30V  
 Protection class IP 67

**Cable:**

E02 = 0,25mm<sup>2</sup>, PVC black  
 H08 = 0,25mm<sup>2</sup>, PUR black, LSOH  
 I02 = 0,25mm<sup>2</sup>, PVC grey irradiated  
 P02 = 0,25mm<sup>2</sup>, PUR/PVC black  
 P08 = 0,25mm<sup>2</sup>, PUR yellow HIFLEX  
 P82 = 0,34mm<sup>2</sup>, PUR black irradiated

**Tolerance:**

≤1 m	+20/-10 mm
1 m - 5 m	±25 mm
5 m - 10 m	±30 mm
> 10 m	±30 mm

6	O-Ring	FPM	---
5	Contact	Copper Alloy	Gold Plated
4	Coupling Nut	Brass	Ni Plated
3	Insert	PUR	---
2	Overmold	PUR	---
1	Cable	See Table	---
ITEM	Part	Material	Finish

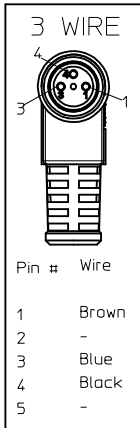

ENTER DESCRIPTION EC NO: IPG2014-1068 DRWN:BBRAUCH 2013/12/09 CHKD: APPR:APOHL 2013/12/09	QUALITY SYMBOLS ▽=0 ▽=0	GENERAL TOLERANCES (UNLESS SPECIFIED)		DIMENSION STYLE MM ONLY		SCALE 1:1	DESIGN UNITS METRIC		THIRD ANGLE PROJECTION	
			mm	INCH	DRAWN BY APOHL	DATE 2011/09/15	TITLE CSE M8 NPN PNP 3P XC FE RA SE UNSH LED NANO-CHANGE			
		4 PLACES	± ---	± ---	CHECKED BY REISSNER	DATE 2012/01/16	MOLEX INCORPORATED			
		3 PLACES	± ---	± ---	APPROVED BY CBURGER	DATE 2012/02/01	DOCUMENT NO. SD-120086-004			
2 PLACES	± ---	± ---	ANGULAR ± 1 °		MATERIAL NO. SEE TABLE		SHEET NO. 1 OF 3			
1 PLACE	± 0.3	± ---	DRAFT WHERE APPLICABLE MUST REMAIN WITHIN DIMENSIONS		SIZE A 4		THIS DRAWING CONTAINS INFORMATION THAT IS PROPRIETARY TO MOLEX INCORPORATED AND SHOULD NOT BE USED WITHOUT WRITTEN PERMISSION			

7

6

5

4

3

2

1

### NUMERICAL CODE (Available parts see table page 3 ff others on request.)

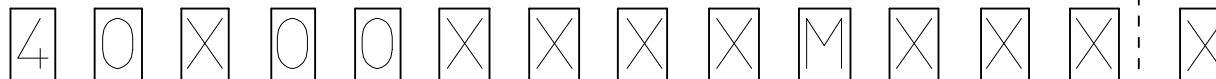

40 = M8x1  
single ended

poles:  
3 = 3 poles

header:  
0N1 = plug female 90° right  
with LED (NPN)  
0P1 = plug female 90° right  
with LED (PNP)

M = meter

length:  
Example  
020 = 2 m

G = Brad in black  
H = Std with ID tag  
7 = Teflon coat

Cable:  
E02 = 0,25mm<sup>2</sup>, PVC black  
H08 = 0,25mm<sup>2</sup>, PUR black, LS0H  
I02 = 0,25mm<sup>2</sup>, PVC grey irradiated  
P02 = 0,25mm<sup>2</sup>, PUR/PVC black  
P08 = 0,25mm<sup>2</sup>, PUR yellow HIFLEX  
P82 = 0,34mm<sup>2</sup>, PUR black irradiated

### Special Types:

ENTER DESCRIPTION EC NO: IPG2014-1068 DRWN:BBRAUCH 2013/12/09 CHKD: APPR:APOHL 2013/12/09	QUALITY SYMBOLS ▽=0 ◻=0	GENERAL TOLERANCES (UNLESS SPECIFIED)		DIMENSION STYLE MM ONLY		SCALE 1:1	DESIGN UNITS METRIC	THIRD ANGLE PROJECTION	
		4 PLACES ± ---	± ---	DRAWN BY APOHL	DATE 2011/09/15	TITLE CSE M8 NPN PNP 3P XC FE RA SE UNSH LED NANO-CHANGE			
3 PLACES ± ---	± ---	CHECKED BY REISSNER	DATE 2012/01/16						
2 PLACES ± ---	± ---	APPROVED BY CBURGER	DATE 2012/02/01	DOCUMENT NO. SD-120086-004				SHEET NO. 2 OF 3	
1 PLACE ± 0.3	± ---	MATERIAL NO. SEE TABLE							
ANGULAR ± 1 °		DRAFT WHERE APPLICABLE MUST REMAIN WITHIN DIMENSIONS		THIS DRAWING CONTAINS INFORMATION THAT IS PROPRIETARY TO MOLEX INCORPORATED AND SHOULD NOT BE USED WITHOUT WRITTEN PERMISSION					

6

5

4

3

2

1

7

6

5

4



3

2

1

## PART LIST:

1200865040	4030N1E02M020
1200868334	4030P1E02M002G
1200270115	4030P1E02M020
1200270117	4030P1E02M050
1200868411	4030P1E02M050H
1200868024	4030P1E02M100
1200868219	4030P1H08M020
1200868167	4030P1H08M030
1200868051	4030P1H08M050
1200270119	4030P1I02M020
1200868335	4030P1I02M030
1200270121	4030P1I02M050
1200868336	4030P1I02M100
1200868337	4030P1P02M020
1200868338	4030P1P02M030
1200868027	4030P1P08M003
1200270123	4030P1P08M020
1200865002	4030P1P08M030
1200270125	4030P1P08M050
1200865027	4030P1P82M050
1200868147	4030P1P82M0507
1200868076	4030P1P82M100

ENTER DESCRIPTION EC NO: IPG2014-1068 DRWN:BBRAUCH 2013/12/09 CHKD: APPR:APOHL 2013/12/09	DESCRIPTION REV	QUALITY SYMBOLS	GENERAL TOLERANCES (UNLESS SPECIFIED)		DIMENSION STYLE MM ONLY		SCALE 1:1	DESIGN UNITS METRIC	THIRD ANGLE PROJECTION	
		 =0  =0	mm	INCH	DRAWN BY APOHL	DATE 2011/09/15	TITLE CSE M8 NPN PNP 3P XC FE RA SE UNSH LED NANO-CHANGE		 MOLEX INCORPORATED DOCUMENT NO. SD-120086-004 SHEET NO. 3 OF 3	
4 PLACES ± --- ± ---	3 PLACES ± --- ± ---	2 PLACES ± --- ± ---	1 PLACE ± 0.3 ± ---	CHECKED BY REISSNER	DATE 2012/01/16	APPROVED BY CBURGER				
DRAFT WHERE APPLICABLE MUST REMAIN WITHIN DIMENSIONS			ANGULAR ± 1 °		MATERIAL NO. SEE TABLE					
THIS DRAWING CONTAINS INFORMATION THAT IS PROPRIETARY TO MOLEX INCORPORATED AND SHOULD NOT BE USED WITHOUT WRITTEN PERMISSION										

6

5

4

3

2

1

# RIGHT ANGLED PLUG WITH LED

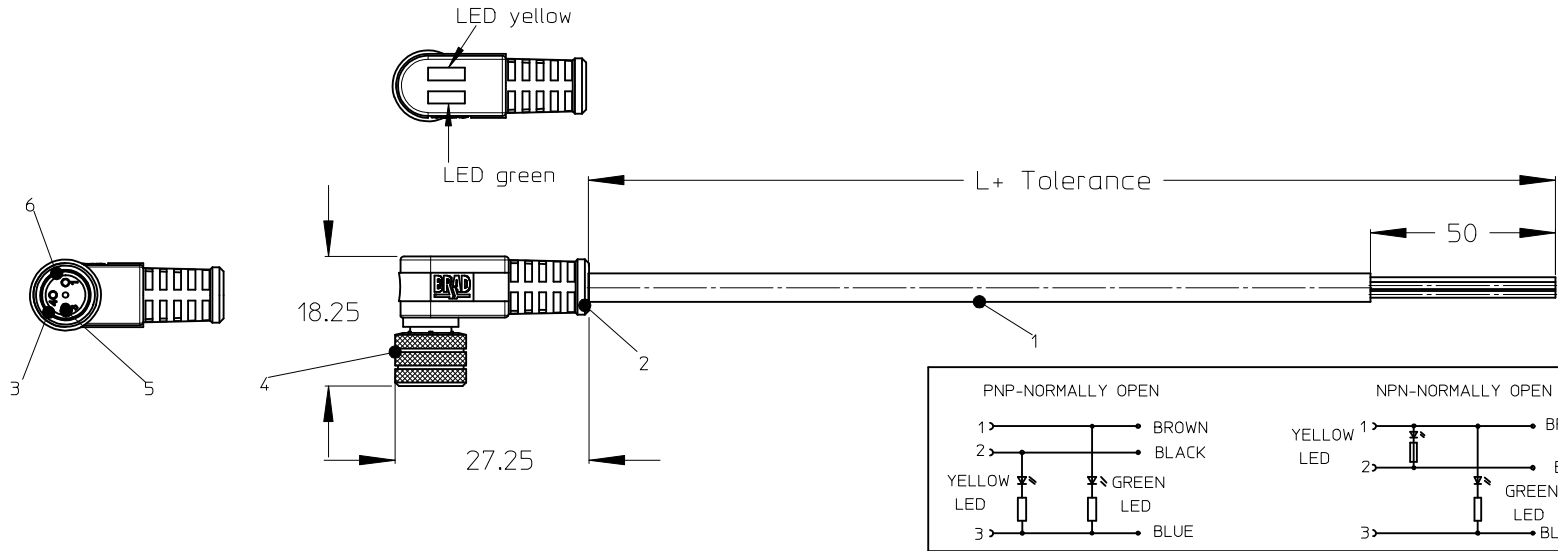

**NOTES:**

Temperatur Range -25°C/+80°C  
 Contact Current Rating 3A  
 Voltage Rating 3 poles max. 30V  
 Protection class IP 67

**Cable:**

E02 = 0,25mm<sup>2</sup>, PVC black  
 H08 = 0,25mm<sup>2</sup>, PUR black, LSOH  
 I02 = 0,25mm<sup>2</sup>, PVC grey irradiated  
 P02 = 0,25mm<sup>2</sup>, PUR/PVC black  
 P08 = 0,25mm<sup>2</sup>, PUR yellow HIFLEX  
 P82 = 0,34mm<sup>2</sup>, PUR black irradiated

**Tolerance:**

≤1 m	+20/-10 mm
1 m - 5 m	±25 mm
5 m - 10 m	±30 mm
> 10 m	±30 mm

6	O-Ring	FPM	---
5	Contact	Copper Alloy	Gold Plated
4	Coupling Nut	Brass	Ni Plated
3	Insert	PUR	---
2	Overmold	PUR	---
1	Cable	See Table	---
ITEM	Part	Material	Finish

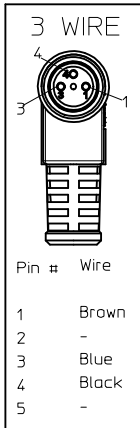

ENTER DESCRIPTION EC NO: IPG2014-1068 DRWN:BBRAUCH 2013/12/09 CHKD: APPR:APOHL 2013/12/09	QUALITY SYMBOLS ▽=0 ▽=0	GENERAL TOLERANCES (UNLESS SPECIFIED)		DIMENSION STYLE MM ONLY		SCALE 1:1	DESIGN UNITS METRIC		THIRD ANGLE PROJECTION	
		4 PLACES	± ---	± ---	DRAWN BY APOHL	DATE 2011/09/15	TITLE CSE M8 NPN PNP 3P XC FE RA SE UNSH LED NANO-CHANGE			
		3 PLACES	± ---	± ---	CHECKED BY REISSNER	DATE 2012/01/16				
		2 PLACES	± ---	± ---	APPROVED BY CBURGER		DATE 2012/02/01	MOLEX INCORPORATED		
1 PLACE	± 0.3	± ---	MATERIAL NO. SEE TABLE		DOCUMENT NO. SD-120086-004	SHEET NO. 1 OF 3				
DRAFT WHERE APPLICABLE MUST REMAIN WITHIN DIMENSIONS				SIZE A 4		THIS DRAWING CONTAINS INFORMATION THAT IS PROPRIETARY TO MOLEX INCORPORATED AND SHOULD NOT BE USED WITHOUT WRITTEN PERMISSION				

7

6

5

4

3

2

1

## NUMERICAL CODE

(Available parts see table page 3 ff others on request.)

## Special Types:

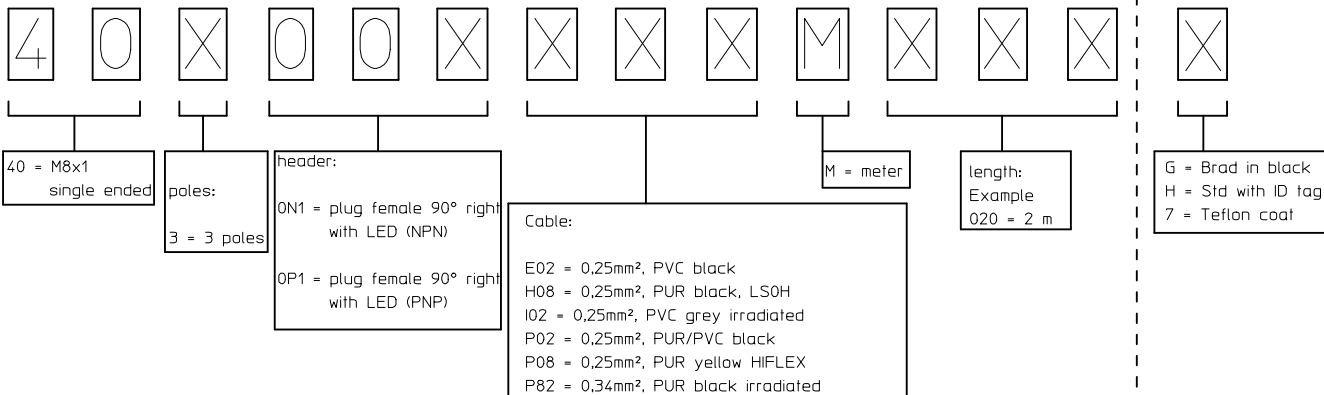

ENTER DESCRIPTION EC NO: IPG2014-1068 DRWN:BBRAUCH 2013/12/09 CHKD: APPR:APOHL 2013/12/09	QUALITY SYMBOLS ▽=0 ▽=0	GENERAL TOLERANCES (UNLESS SPECIFIED)		DIMENSION STYLE MM ONLY		SCALE 1:1	DESIGN UNITS METRIC	THIRD ANGLE PROJECTION	
		4 PLACES ± --- ± ---	3 PLACES ± --- ± ---	2 PLACES ± --- ± ---	1 PLACE ± 0.3 ± ---	mm	INCH	DRAWN BY DATE APOHL 2011/09/15	
2	REV	DRAFT WHERE APPLICABLE MUST REMAIN WITHIN DIMENSIONS		MATERIAL NO. SEE TABLE		DOCUMENT NO. SD-120086-004		SHEET NO. 2 OF 3	
		ANGULAR ± 1 °		APPROVED BY DATE CBURGER 2012/02/01		MOLEX MOLEX INCORPORATED		THIS DRAWING CONTAINS INFORMATION THAT IS PROPRIETARY TO MOLEX INCORPORATED AND SHOULD NOT BE USED WITHOUT WRITTEN PERMISSION	

6

5

4

3

2

1

7

6

5

4

3

2

1

## PART LIST:

1200865040	4030N1E02M020
1200868334	4030P1E02M002G
1200270115	4030P1E02M020
1200270117	4030P1E02M050
1200868411	4030P1E02M050H
1200868024	4030P1E02M100
1200868219	4030P1H08M020
1200868167	4030P1H08M030
1200868051	4030P1H08M050
1200270119	4030P1I02M020
1200868335	4030P1I02M030
1200270121	4030P1I02M050
1200868336	4030P1I02M100
1200868337	4030P1P02M020
1200868338	4030P1P02M030
1200868027	4030P1P08M003
1200270123	4030P1P08M020
1200865002	4030P1P08M030
1200270125	4030P1P08M050
1200865027	4030P1P82M050
1200868147	4030P1P82M0507
1200868076	4030P1P82M100

ENTER DESCRIPTION EC NO: IPG2014-1068 DRWN:BBRAUCH 2013/12/09 CHKD: APPR:APOHL 2013/12/09	QUALITY SYMBOLS ▽=0 ▽C=0	GENERAL TOLERANCES (UNLESS SPECIFIED)		DIMENSION STYLE MM ONLY		SCALE 1:1	DESIGN UNITS METRIC	THIRD ANGLE PROJECTION	
			mm	INCH	DRAWN BY APOHL	DATE 2011/09/15	TITLE CSE M8 NPN PNP 3P XC FE RA SE UNSH LED NANO-CHANGE		
2	DESCRIPTION REV	4 PLACES	± ---	± ---	CHECKED BY REISSNER	DATE 2012/01/16	MOLEX INCORPORATED DOCUMENT NO. SD-120086-004		
		3 PLACES	± ---	± ---	APPROVED BY CBURGER	DATE 2012/02/01			
		2 PLACES	± ---	± ---	DRAFT WHERE APPLICABLE MUST REMAIN WITHIN DIMENSIONS				
		1 PLACE	± 0.3	± ---					
		ANGULAR ± 1 °		THIS DRAWING CONTAINS INFORMATION THAT IS PROPRIETARY TO MOLEX INCORPORATED AND SHOULD NOT BE USED WITHOUT WRITTEN PERMISSION					

6

5

4

3

2

1