

Contacteur Statique Triphasé Power Three Phase Solid State Contactor

SIT865990 (SVT865990-WH)

24-520 VAC

see derating curve
(AC-51 : 3 x 22 ARMS)
(AC-53 : 3 x 12 ARMS)
90-240 VAC control

- ❑ Contacteur statique synchrone Triphasé prêt à l'emploi adapté à tout type de charges
Ready to use Three phase ZeroCross Solid State Contactor designed for all types of loads.
- ❑ Sortie thyristors hautes performances technologie TMS² (*)
permettant une longue durée de vie: **24 à 520VAC 50A** ($I^2t > 1500A^2s$)
New High Efficiency Back to back thyristors on output with TMS² technology() for a long lifetime expectancy: 24 to 520VAC 50A*
 $I^2t > 1500A^2s$ (**)
- ❑ Tension de commande 90-240VAC
LED de visualisation sur l'entrée de couleur verte.
Control range: 90-240VAC.
Green LED visualization on the input.
- ❑ Haute Immunité et Protection de la tension de sortie par RC et varistor.
High Immunity and output voltage protection by RC and VDR
- ❑ Livré en standard avec dissipateur intégré montable sur rail DIN et protection contre le toucher IP20
Delivered with integrated heatsink for DIN rail mounting and with IP20 protection cover.
- ❑ Construit en conformité aux normes EN60947-4-3 (IEC947-4-3) et EN60950/VDE0805 (Isolement renforcé) -UL-cUL
Designed in conformity with EN60947-4-3 (IEC947-4-3) and EN60950/VDE0805 (Reinforced Insulation) -UL-cUL

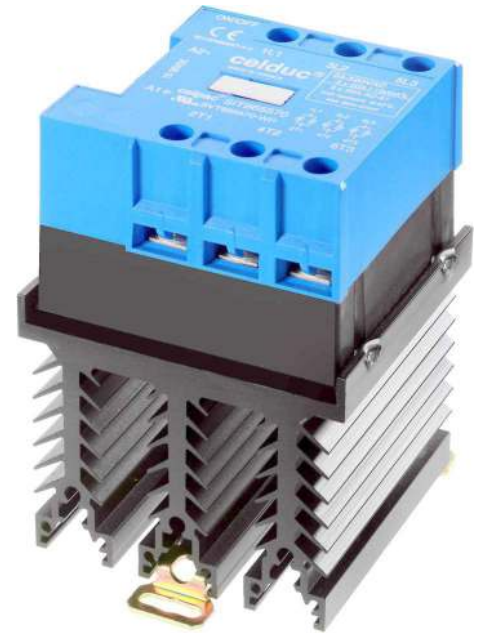

(**): Modèle 5000A²s sur demande ; 5000A²s model on request

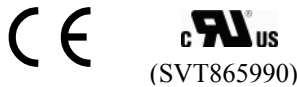

Caractéristiques de commande (à 20°C) / Control characteristics (at 20°C)

Paramètre / Parameter	Symbol	AC-DC			Unit
		Min	Nom	Max	
Tension de commande / Control voltage : DC	Uc	90		240	VDC
Tension de commande / Control voltage : AC	Uc	90		240	VAC
Courant de commande / Control current (@ Uc)	Ic	4,5		11	mA
Tension de relachement/Release voltage	Uc off	15			V
Résistance interne / Input internal resistor fig.1	Rc		21		KΩ
Tension inverse / Reverse voltage	Urv		polarity free		V

fig. 1 : Caractéristique d'entrée / Control characteristic

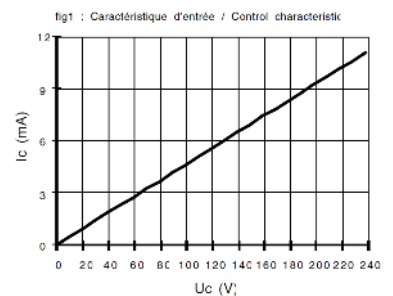

Caractéristiques d'entrée-sortie (à 20°C) / Input-output characteristics (at 20°C)

Isolement entrée-sortie/ Input-output isolation @500m	Ui		4000		VRMS
Isolement sortie-semelle/ Output-case isolation @500m	Ui		3300		VRMS
Tension assignée isolement/ Rated impulse voltage	Uimp		4000		V

General characteristics

Parameter	Conditions	Symbol	Typ.	Unit
Poids/Weight			1000	g
Température de fonctionnement / Ambient temperature (no icing, no condensation)			-40 / +100	°C
Température de stockage/ Storage temperature (no icing, no condensation)			-40 / +80	°C

(*) : Thermo Mechanical Stress Solution

Proud to serve you

Caractéristiques de sortie / Output characteristics (at 25°C)

Paramètre / Parameter	Conditions	Symbol	Min	Typ.	Max	Unit
Plage de tension utilisation / Operating voltage range		Ue	24	400	520	V rms
Tension de crête (écrêtage VDR) / Peak voltage (VDR clamping)	@ 1mA	Up	1200 (950)			V
Niveau de synchronisme / Zero cross level		U _{sync}			12	V
Tension minimum amorçage / Latching voltage	Ie nom	Ua	10			V
Courant nominal / nominal current (AC-51)	Resistance	Ie AC-51	3x22A (see derating curve)			A rms
Courant nominal / nominal current (AC-53)	Motor	Ie AC-53		3*12A		A rms
Courant surcharge / Non repetitive overload current	tp=10ms (Fig. 3)	I _{tsm}	550	720		A
Chute directe à l'état passant / On state voltage drop	@ 25°C	V _t			0,9	V
Résistance dynamique / On state dynamic resistance		r _t			12	mΩ
Puissance dissipée (max) / Output power dissipation (max value)		P _d	(0,9x0,9xIe + 0,012xIe ²)*3			W
Résistance thermique jonction/semelle / Thermal resistance between junction to case		R _{thj/c}		1 leg	0,45	K/W
Courant de fuite à l'état bloqué / Off state leakage current	@Ue typ, 50Hz	I _{lk}			1	mA
Courant minimum de charge / Minimum load current		I _{emin}	5			mA
Temps de fermeture / Turn on time	@Ue typ, 50Hz	t _{on max}			30	ms
Temps d'ouverture / Turn off time	@Ue typ, 50Hz	t _{off max}			30	ms
Fréquence utilisation / Operating frequency range	F mains	f	0,1	50-60	800	Hz
dv/dt à l'état bloqué / Off state dv/dt		dv/dt	500			V/μs
di/dt max / Maximum di/dt non repetitive		di/dt			50	A/μs
I _{2t} (<10ms)		I ² _t	1500	2500		A ² s
Immunité / Conducted immunity level	IEC/EN61000-4-4 (bursts)		4kV criterion A			
Immunité / Conducted immunity level	IEC/EN61000-4-5 (surge)		4kV criterion A			
Protection court-circuit / Short circuit protection	voir/see page 6	Example	Fuse Ferraz gRC 25A/32A/50A			

COURBES THERMIQUES / thermal curves:

curve 1 :

with ventilation in the heatsink (> 1m/s)
(avec ventilation significative du dissipateur)

curve 2 :

working in normal conditions with a small
ventilation in the cabinet (avec petite ventila-
tion d'armoire)

curve 3 :

according with IEC60947-4-2
in a closed cabinet without any ventilation.
(absence totale de ventilation)

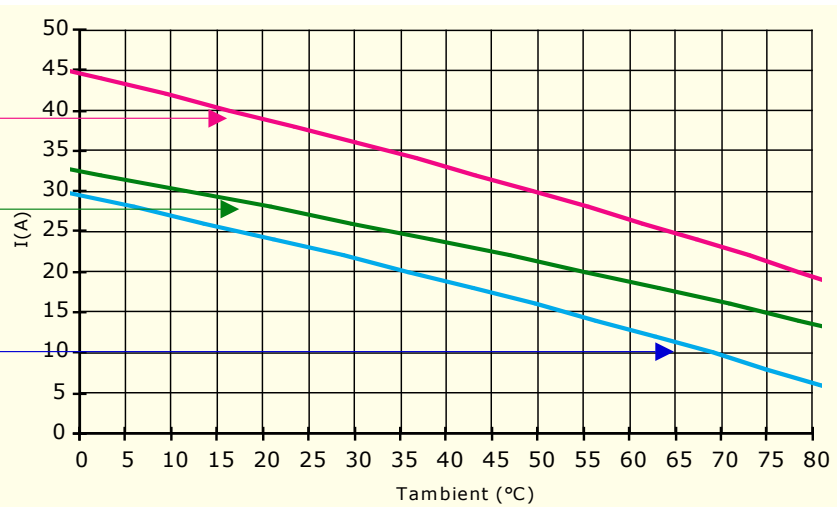

1 -I_{tsm} non répétitif sans tension réappliquée est donné pour la détermination des protections.

1 - No repetitive I_{tsm} is given without voltage reappplied. This curve is used to define the protection (fuses).

2 -I_{tsm} répétitif est donné pour des surcharges de courant (T_j initiale=70°C).

Attention : la répétition de ces surcharges de courant diminue la durée de vie du relais.

2 - Repetitive I_{tsm} is given for inrush current with initial T_j = 70°C. In normal operation, this curve mustn't be exceeded.

Be careful, the repetition of the surge current decreases the life expectancy of the SSR.

fig 3 : Courants de surcharges / Overload currents

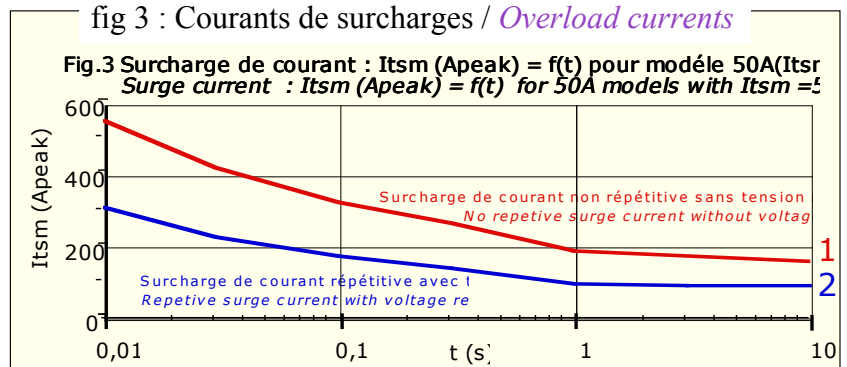



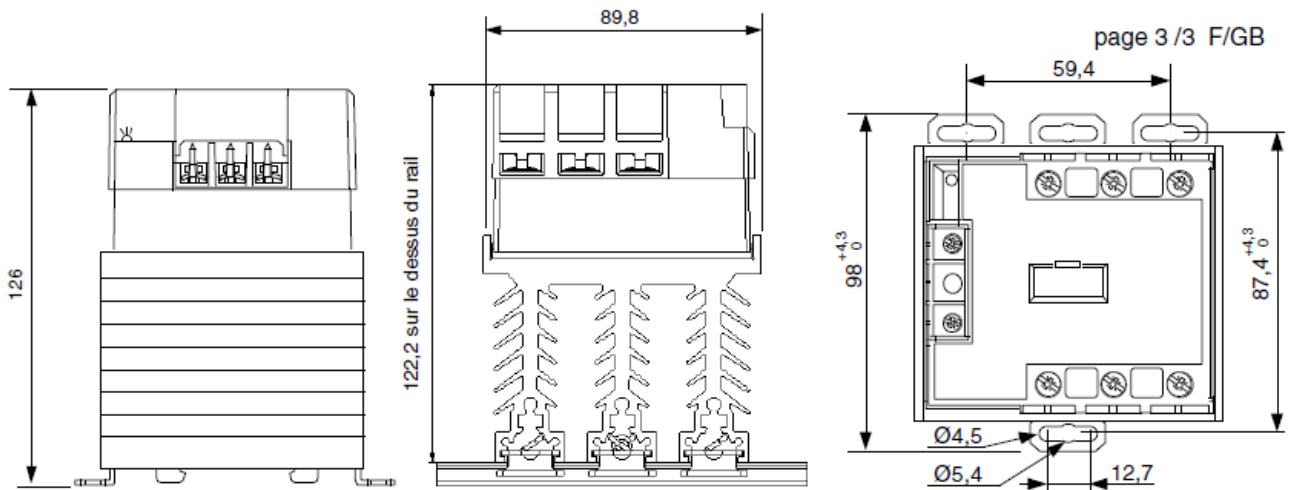

celduc[®]
relais

www.celduc.com

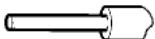
5, Rue Ampère BP30004 42290 SORBIERS - FRANCE E-mail : celduc-relais@celduc.com
Fax +33 (0) 4 77 53 85 51 Service Commercial France Tél. : +33 (0) 4 77 53 90 20
Sales Dept.For Europe Tel. : +33 (0) 4 77 53 90 21 Sales Dept. Asia : Tél. +33 (0) 4 77 53 90 19

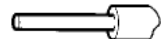

SIT/SVT				Raccordement d'entrée / Control wiring	
Nombre de fils / Number of wires				Modèle de tournevis / Screwdriver type	Couple de serrage recommandé Recommended Torque
1		2			
Fil rigide (sans embout) SOLID (No ferrule)	Fil multibrins (avec embout) FINE STRANDED (With ferrule)	Fil rigide (sans embout) SOLID (No ferrule)	Fil multibrins (avec embout) FINE STRANDED (With ferrule)		M4
					N.m
0,75 ... 2,5 mm AWG18...AWG14	0,75 ... 2,5 mm AWG18...AWG14	0,75 ... 2,5 mm AWG18...AWG14	0,75 ... 2,5 mm AWG18...AWG14		POZIDRIV 2

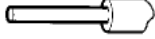
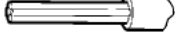
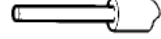
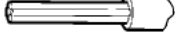
celpac[®]				Raccordement de puissance / Power wiring	
Nombre de fils / Number of wires				Modèle de tournevis / Screwdriver type	Couple de serrage recommandé Recommended Torque
1		2			
Fil rigide (sans embout) SOLID (No ferrule)	Fil multibrins (avec embout) FINE STRANDED (With ferrule)	Fil rigide (sans embout) SOLID (No ferrule)	Fil multibrins (avec embout) FINE STRANDED (With ferrule)		M5
					N.m
1,5 ... 10 mm ² AWG16...AWG8	1,5 ... 6 mm ² AWG16...AWG10	1,5 ... 10 mm ² AWG16...AWG8	1,5 ... 6 mm ² AWG16...AWG10		POZIDRIV 2



celduc[®]
r e l a i s

www.celduc.com

5, Rue Ampère BP30004 42290 SORBIERS - FRANCE E-mail : celduc-relais@celduc.com
 Fax +33 (0) 4 77 53 85 51 Service Commercial France Tél. : +33 (0) 4 77 53 90 20
 Sales Dept.For Europe Tel. : +33 (0) 4 77 53 90 21 Sales Dept. Asia : Tél. +33 (0) 4 77 53 90 19

APPLICATION TYPIQUE /
Typical application:

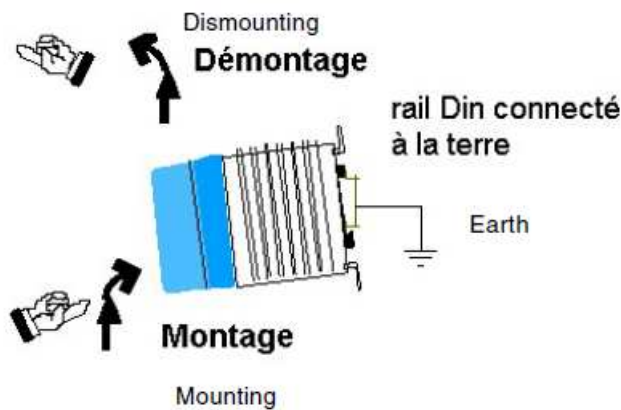
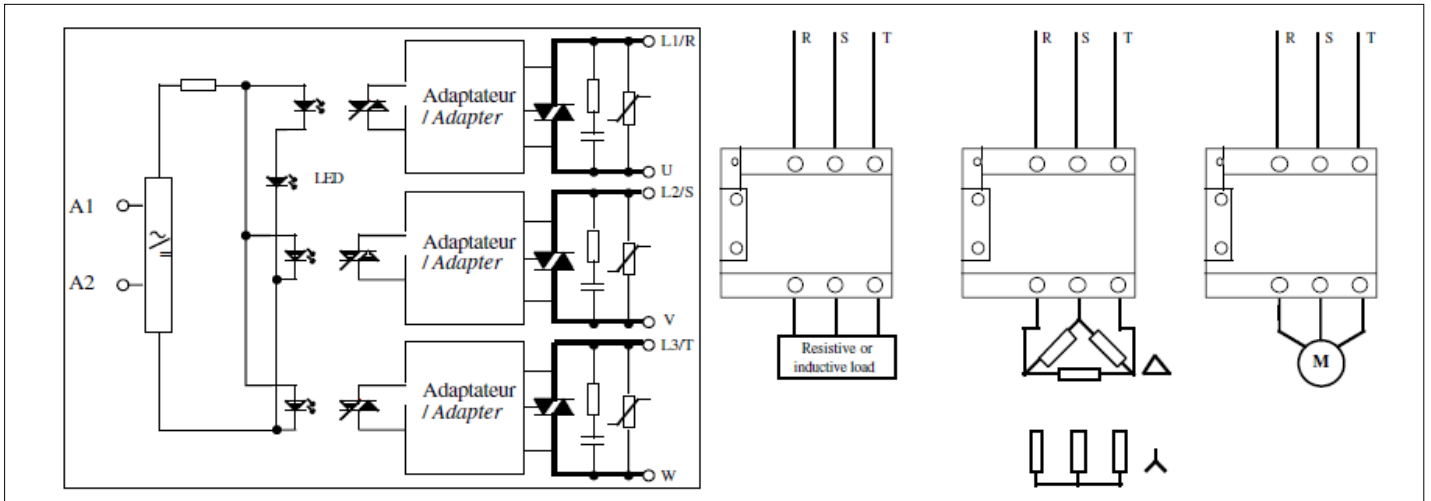

celduc®
 r e l a i s

www.celduc.com

5, Rue Ampère BP30004 42290 SORBIERS - FRANCE E-mail : celduc-relais@celduc.com
 Fax +33 (0) 4 77 53 85 51 Service Commercial France Tél. : +33 (0) 4 77 53 90 20
 Sales Dept.For Europe Tel. : +33 (0) 4 77 53 90 21 Sales Dept. Asia : Tél. +33 (0) 4 77 53 90 19