

# PQ150VB01FZ/PQ150VB02FZ

Variable Output Low Power-Loss Voltage Regulator (Built-in Overheat Shutdown function, Output ON/OFF control function)

## Features

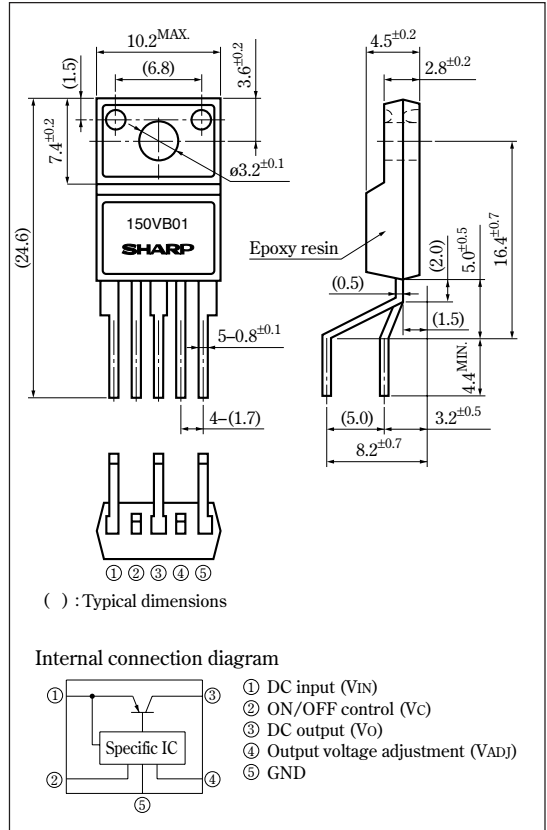
- Low power-loss  
(Dropout voltage: MAX. 0.5V at  $I_o=0.5A$ )
- Overheat shut-down function
- Variable output voltage (setting range: 1.5 to 15V)  
(Equivalent to TO-220)
- With built-in overcurrent protection
- Reference voltage precision:  $\pm 2.0\%$

## Applications

- Series power supply for TVs and VTRs
- Power supplies for equipment
- CRT displays

## Outline Dimensions

(Unit : mm)



## Absolute Maximum Ratings

( $T_a=25^\circ C$ )

Parameter	Symbol	Rating	Unit
*1 Input voltage	$V_{IN}$	17	V
*1 ON/OFF control terminal voltage	$V_C$	17	V
*1 Output adjustment terminal voltage	$V_{ADJ}$	5	V
Output current	PQ150VB01FZ	1	A
	PQ150VB02FZ	2	
*2 Power dissipation	$P_{D1}$	1.25	W
	$P_{D2}$	12.5	W
*3 Junction temperature	$T_j$	150	$^\circ C$
Operating temperature	$T_{opr}$	-40 to + 85	$^\circ C$
Storage temperature	$T_{stg}$	-40 to +150	$^\circ C$
Soldering temperature	$T_{sol}$	260 (10s)	$^\circ C$

\*1 All are open except GND and applicable terminals  
\*2 Overheat shut-down function operates at  $T_j \geq 110^\circ C$

• Please refer to the chapter " Handling Precautions ".

**SHARP**

**Electrical Characteristics**

(Unless otherwise specified, condition shall be  $V_{IN}=5V$ ,  $V_O=3V$ ,  $I_O=0.5A$ [PQ150VB01FZ],  $1A$ [PQ150VB02FZ],  $R_I=1k\Omega$ ,  $V_C=2.7V$ ,  $T_a=25^\circ C$ )

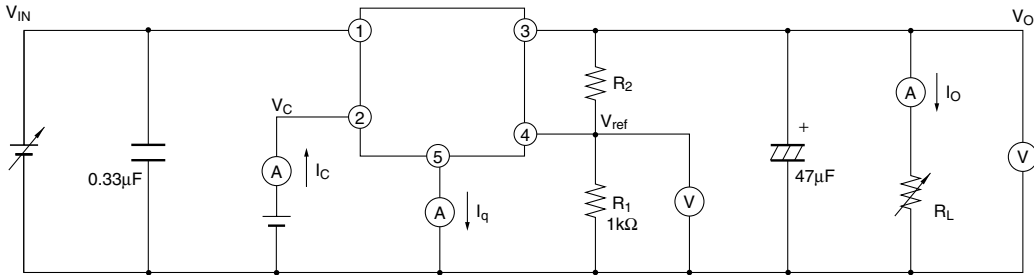
Parameter	Symbol	Conditions	MIN.	TYP.	MAX.	Unit
Minimum operating supply voltage	$V_{IN}$	—	2.35	—	—	V
Output voltage	$V_O$	—	1.5	—	15	V
Load regulation	$R_{egL}$	*3	—	0.3	1.0	%
Line regulation	$R_{egI}$	$V_{IN}=4$ to $10V, I_O=5mA$	—	0.5	1.0	%
Ripple rejection	RR	—	45	55	—	dB
Reference voltage	$V_{ref}$	—	1.215	1.24	1.265	V
Reference voltage temperature coefficient	$T_C V_{ref}$	$T_j=0$ to $110^\circ C, I_O=5mA$	—	$\pm 1.0$	—	%
Dropout voltage	$V_{I-O}$	*4 $I_O=0.5A$ (PQ150VB01FZ), $I_O=2A$ (PQ150VB02FZ)	—	—	0.5	V
*5 ON-state voltage for control	$V_C (ON)$	—	2.0	—	—	V
ON-state current for control	$I_C (ON)$	$V_C=2.7V$	—	—	200	$\mu A$
OFF-state voltage for control	$V_C (OFF)$	—	—	—	0.8	V
OFF-state current for control	$I_C (OFF)$	$V_C=0.4V$	—	—	2	$\mu A$
Quiescent current	$I_q$	$I_O=0$	—	—	5	mA
Output OFF-state consumption current	$I_{qs}$	$I_O=0A, V_C=0.4V$	—	—	5	$\mu A$
Overheating shutdown temperature	$T_{SD}$	—	110	130	150	$^\circ C$

\*3 PQ150VB01FZ :  $I_O=5mA$  to  $1A$ , PQ150VB02FZ :  $I_O=5mA$  to  $2A$

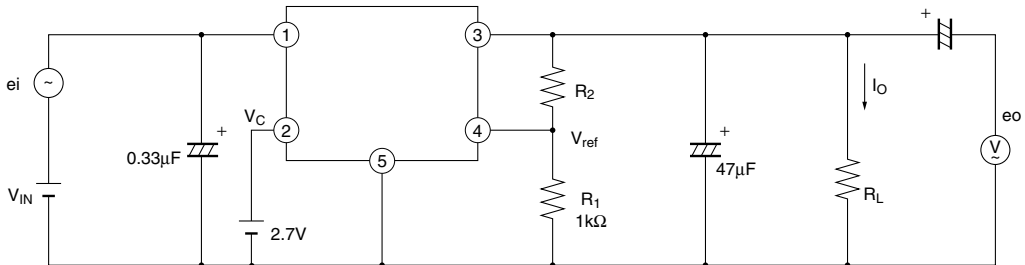
\*4 Input voltage shall be the value when output voltage is 95% in comparison with the initial value

\*5 In case of opening ON/OFF control terminal ②, output voltage turns off

**Fig.1 Test Circuit**

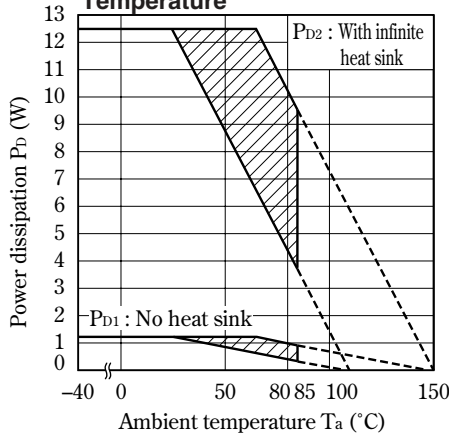


**Fig.2 Test Circuit for Ripple Rejection**



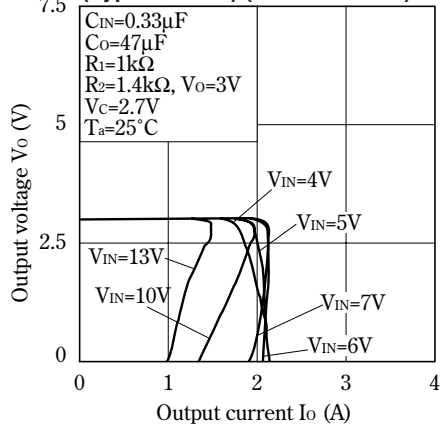
$f=120Hz$ (sine wave)  
 $e_i(rms)=0.5V$   
 $V_O=3V(R_1=1k\Omega)$   
 $V_{IN}=5V$   
 $I_O=0.5A$   
 $RR=20\log(e_i(rms)/e_o(rms))$

**Fig.3 Power Dissipation vs. Ambient Temperature**

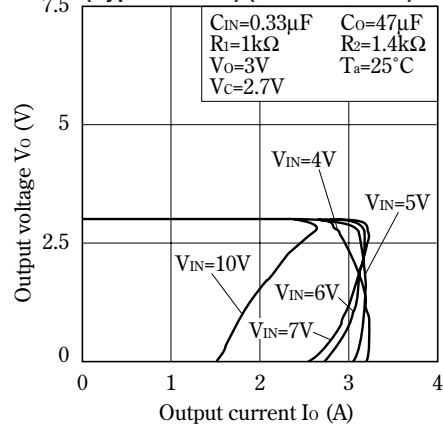


Note) Oblique line portion: Overheat shutdown function operates in this area

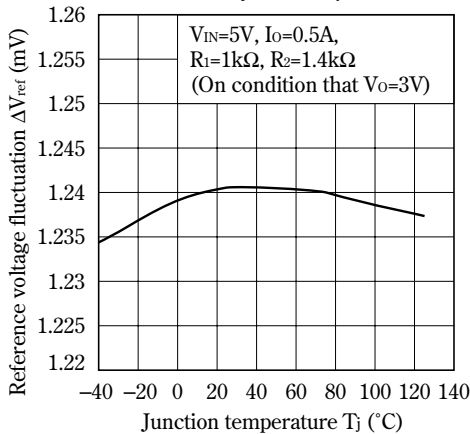
**Fig.4 Overcurrent Protection Characteristics (Typical Value) (PQ150VB01FZ)**



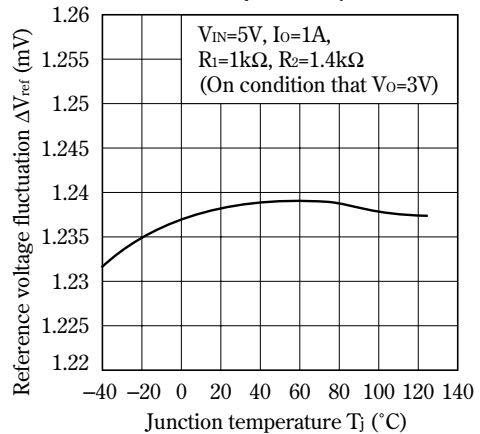
**Fig.5 Overcurrent Protection Characteristics (Typical Value) (PQ150VB02FZ)**



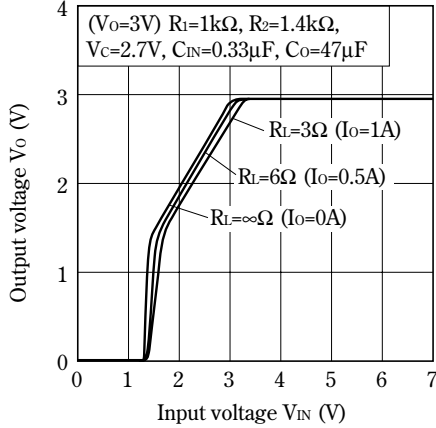
**Fig.6 Reference Voltage Fluctuation vs. Junction Temperature (PQ150VB01FZ)**



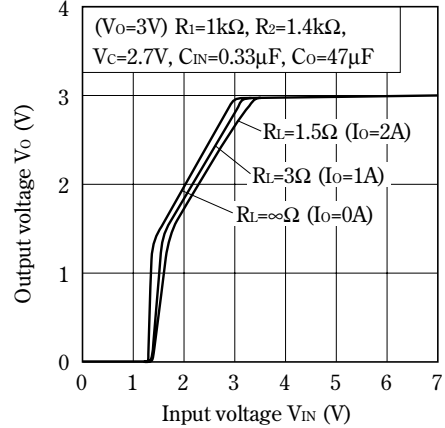
**Fig.7 Reference Voltage Fluctuation vs. Junction Temperature (PQ150VB02FZ)**



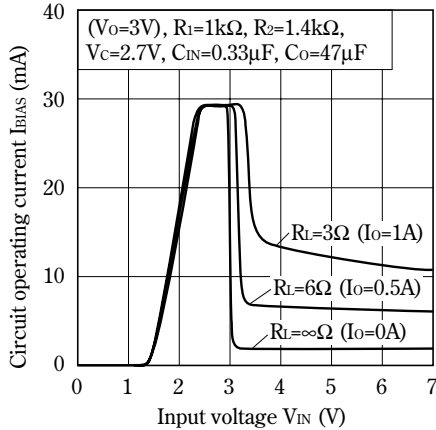
**Fig.8 Output Voltage vs. Input Voltage (PQ150VB01FZ)**



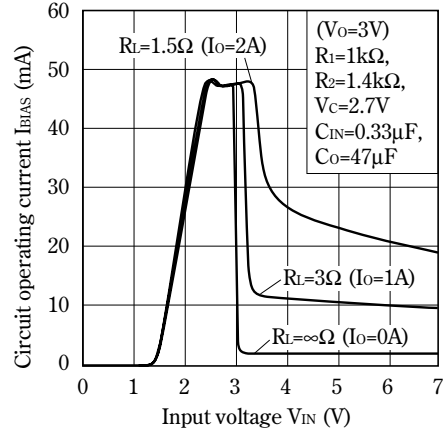
**Fig.9 Output Voltage vs. Input Voltage (PQ150VB02FZ)**



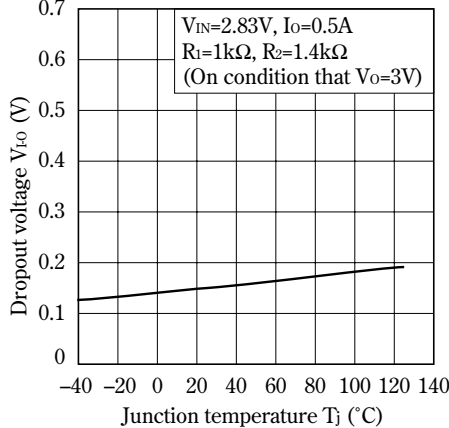
**Fig.10 Circuit Operating Current vs. Input Voltage (PQ150VB01FZ)**



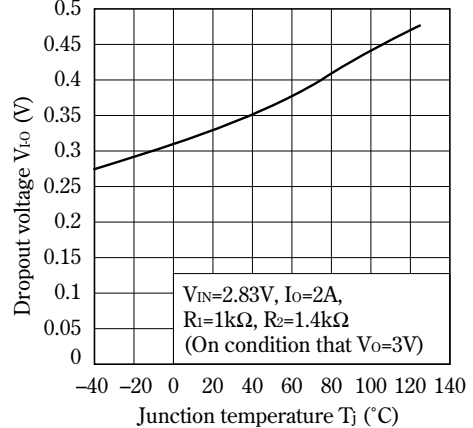
**Fig.11 Circuit Operating Current vs. Input Voltage (PQ150VB02FZ)**



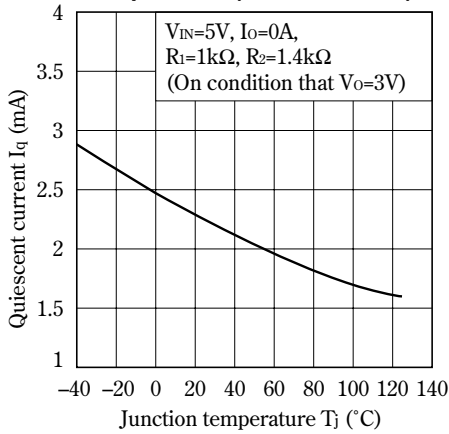
**Fig.12 Dropout Voltage vs. Junction Temperature (PQ150VB01FZ)**



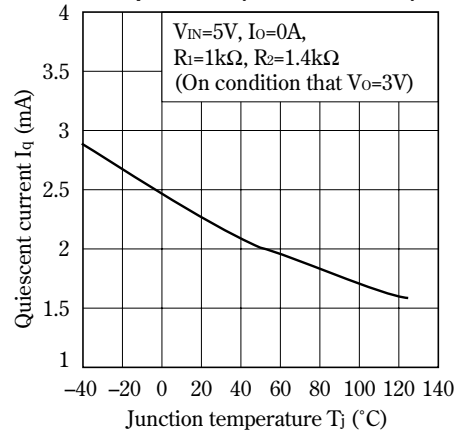
**Fig.13 Dropout Voltage vs. Junction Temperature (PQ150VB02FZ)**



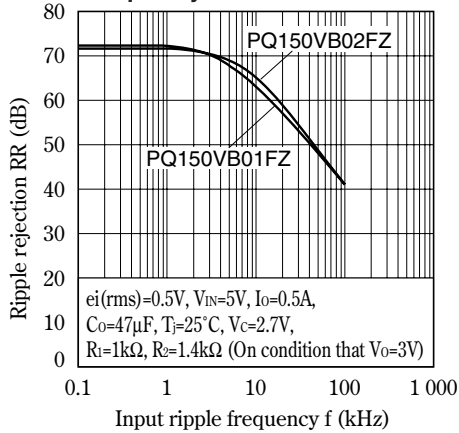
**Fig.14 Quiescent Current vs. Junction Temperature (PQ150VB01FZ)**



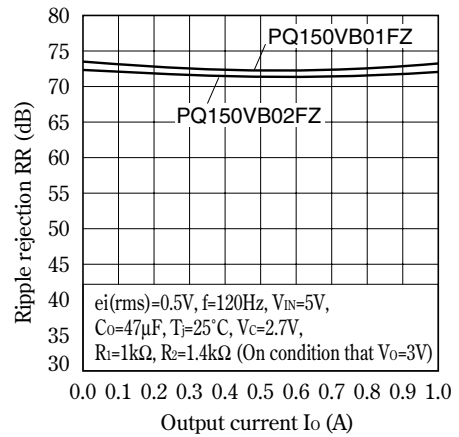
**Fig.15 Quiescent Current vs. Junction Temperature (PQ150VB02FZ)**



**Fig.16 Ripple Rejection vs. Input Ripple Frequency**

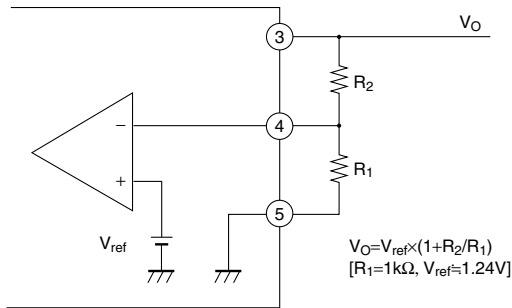


**Fig.17 Ripple Rejection vs. output Current**

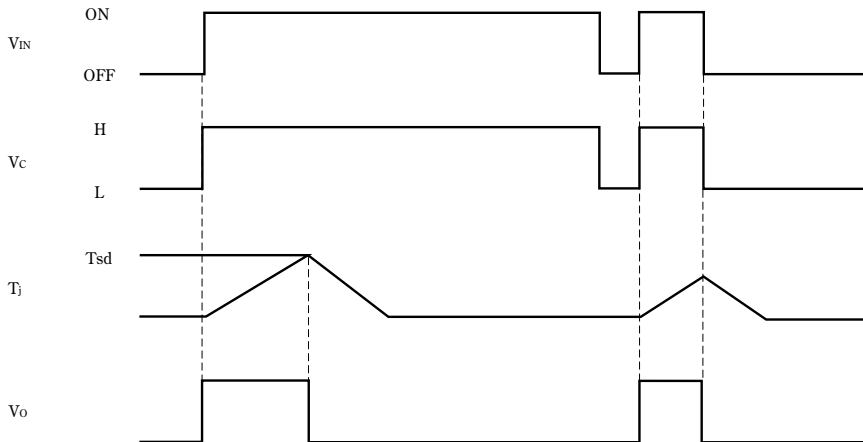


■ Setting of Output Voltage

Output voltage is able to set from 1.5V to 25V when resistors R<sub>1</sub> and R<sub>2</sub> are attached to ③, ④, ⑤ terminals. As for the external resistors to set output voltage, refer to the figure below.



■ Overheat Shut-down Characteristics (Typical Value)



\*T<sub>sd</sub>: Overheat shut-down temperature (T<sub>j</sub> ≥ 110°C)

- (1) Overheat shut-down operates at T<sub>j</sub> = T<sub>sd</sub> and output OFF-state is maintained.
- (2) OFF-state is kept until V<sub>IN</sub> is once turned off or V<sub>C</sub> is turned down to the "L" level.

## NOTICE

- The circuit application examples in this publication are provided to explain representative applications of SHARP devices and are not intended to guarantee any circuit design or license any intellectual property rights. SHARP takes no responsibility for any problems related to any intellectual property right of a third party resulting from the use of SHARP's devices.
- Contact SHARP in order to obtain the latest device specification sheets before using any SHARP device. SHARP reserves the right to make changes in the specifications, characteristics, data, materials, structure, and other contents described herein at any time without notice in order to improve design or reliability. Manufacturing locations are also subject to change without notice.
- Observe the following points when using any devices in this publication. SHARP takes no responsibility for damage caused by improper use of the devices which does not meet the conditions and absolute maximum ratings to be used specified in the relevant specification sheet nor meet the following conditions:
  - (i) The devices in this publication are designed for use in general electronic equipment designs such as:
    - Personal computers
    - Office automation equipment
    - Telecommunication equipment [terminal]
    - Test and measurement equipment
    - Industrial control
    - Audio visual equipment
    - Consumer electronics
  - (ii) Measures such as fail-safe function and redundant design should be taken to ensure reliability and safety when SHARP devices are used for or in connection with equipment that requires higher reliability such as:
    - Transportation control and safety equipment (i.e., aircraft, trains, automobiles, etc.)
    - Traffic signals
    - Gas leakage sensor breakers
    - Alarm equipment
    - Various safety devices, etc.
  - (iii) SHARP devices shall not be used for or in connection with equipment that requires an extremely high level of reliability and safety such as:
    - Space applications
    - Telecommunication equipment [trunk lines]
    - Nuclear power control equipment
    - Medical and other life support equipment (e.g., scuba).
- If the SHARP devices listed in this publication fall within the scope of strategic products described in the Foreign Exchange and Foreign Trade Law of Japan, it is necessary to obtain approval to export such SHARP devices.
- This publication is the proprietary product of SHARP and is copyrighted, with all rights reserved. Under the copyright laws, no part of this publication may be reproduced or transmitted in any form or by any means, electronic or mechanical, for any purpose, in whole or in part, without the express written permission of SHARP. Express written permission is also required before any use of this publication may be made by a third party.
- Contact and consult with a SHARP representative if there are any questions about the contents of this publication.