

# SACC-M12MS-5CON-PG11 SH - Connector



1403854

<https://www.phoenixcontact.com/us/products/1403854>

Please be informed that the data shown in this PDF document is generated from our online catalog. Please find the complete data in the user documentation. Our general terms of use for downloads are valid.



Connector, 5-position, shielded, Plug straight M12, A, Screw connection, knurl material: Zinc die-cast, nickel-plated, cable gland Pg11, external cable diameter 8 mm ... 10 mm

## Your advantages

- Safe use in the field, thanks to a high degree of protection
- Screw connection: proven connection technology for a large selection of different conductors
- Reliable signal transmission – 360° shielding in environments with electromagnetic interference

## Commercial data

Item number	1403854
Packing unit	1 pc
Minimum order quantity	1 pc
Sales key	BF30
Product key	BF2CBA
GTIN	4046356671279
Weight per piece (including packing)	54.87 g
Weight per piece (excluding packing)	54.87 g
Customs tariff number	85366990
Country of origin	DE

# SACC-M12MS-5CON-PG11 SH - Connector



1403854

<https://www.phoenixcontact.com/us/products/1403854>

## Technical data

### Notes

General	<b>NOTE:</b> Observe the permissible bending radii when laying conductors, since the degree of protection may be put in jeopardy if the bending forces are too high. Alleviate mechanical loads upstream of the connector, e.g. by using cable ties.
---------	--

### Mounting

Connection method	Screw connection
-------------------	------------------

### Product properties

Product type	Circular connector (cable-side)
Number of positions	5
No. of cable outlets	1
Shielded	yes
Coding	A
Cable outlet	straight
Pg screw connection	Pg11

### Insulation characteristics

Overvoltage category	II
Degree of pollution	3

### Dimensions

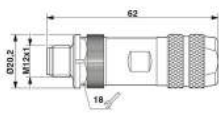
Dimensional drawing	
Length	62 mm
Wrench size, union nut	16 mm

### External dimensions

Outside diameter	8 mm ... 10 mm
------------------	----------------

### Housing

Diameter housing	20.2 mm
------------------	---------

### Material specifications

Flammability rating according to UL 94	HB
Seal material	NBR
Material of grip body	Zinc die-cast, nickel-plated
Contact material	CuZn
Contact surface material	Au

# SACC-M12MS-5CON-PG11 SH - Connector



1403854

<https://www.phoenixcontact.com/us/products/1403854>

Contact carrier material	PA
Material for screw connection	Zinc die-cast, nickel-plated

## Connection data

### Conductor connection

Connection method	Screw connection
Connection cross section	0.25 mm <sup>2</sup> ... 0.75 mm <sup>2</sup> (without ferrule)
	0.14 mm <sup>2</sup> ... 0.75 mm <sup>2</sup> (with ferrule)
	0.25 mm <sup>2</sup> ... 0.75 mm <sup>2</sup> (solid)
Connection cross section AWG	24 ... 18 (without ferrule)
	26 ... 20 (with ferrule)
Stripping length of the individual wire	5 mm
Tightening torque	0.4 Nm (M12 knurl)
	0.2 Nm (Screw terminal blocks)
	1 Nm ... 1.4 Nm (Pressure nut with 8 mm ... 12 mm external cable diameter)

## Electrical properties

Rated surge voltage	1.5 kV
Contact resistance	≤ 3 mΩ
Insulation resistance	≥ 100 MΩ
Nominal voltage U <sub>N</sub>	48 V AC
	60 V DC
Nominal current I <sub>N</sub>	4 A

## Mechanical properties

### Mechanical data

Insertion/withdrawal cycles	≥ 100
-----------------------------	-------

## Connector

### Connection 1

Head design	Plug
Head cable outlet	straight
Head thread type	M12
Coding	A

## Cable/line

Stripping length of the individual wire	5 mm
---	------

## Environmental and real-life conditions

### Ambient conditions

Degree of protection	IP67
Ambient temperature (operation)	-40 °C ... 85 °C (Plug / socket)

# SACC-M12MS-5CON-PG11 SH - Connector



1403854

<https://www.phoenixcontact.com/us/products/1403854>

## Standards and regulations

Standard designation	M12 connector
Standards/specifications	IEC 61076-2-101

# SACC-M12MS-5CON-PG11 SH - Connector

1403854

<https://www.phoenixcontact.com/us/products/1403854>

## Drawings

Schematic diagram

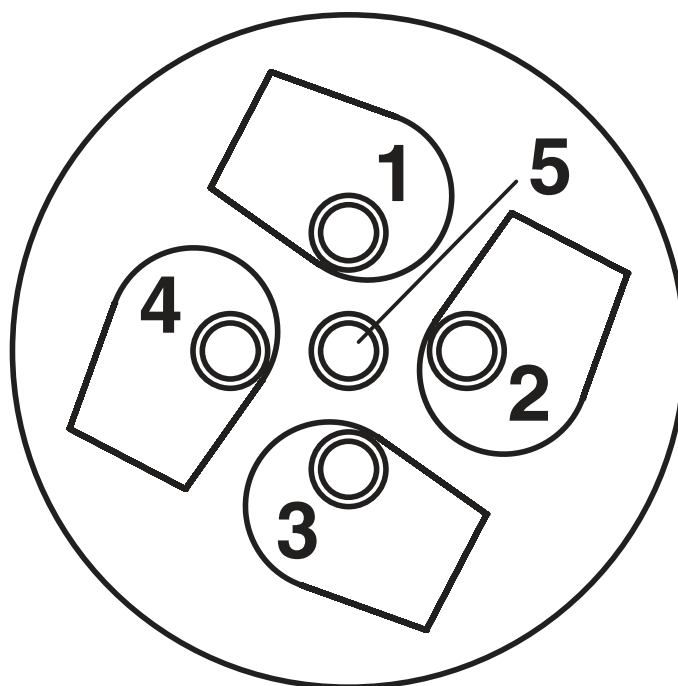

Cable connection side M12 (screw connection)

1403854

<https://www.phoenixcontact.com/us/products/1403854>

Functional drawing

## Assembly steps for M 12 male/female connector and conductor

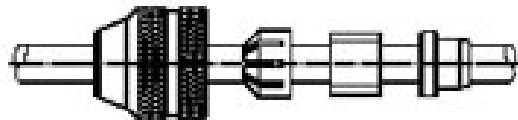

Slide parts onto the conductor

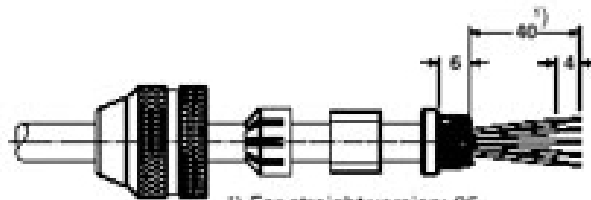

Strip conductor, widen shield and lay around the shielding ring, cut off projecting mesh.

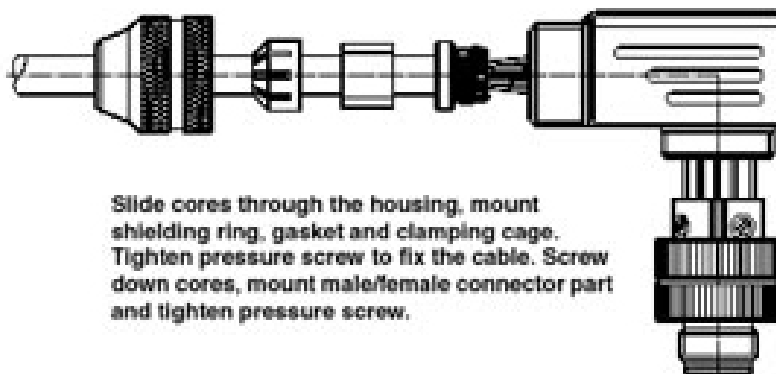

Slide cores through the housing, mount shielding ring, gasket and clamping cage. Tighten pressure screw to fix the cable. Screw down cores, mount male/female connector part and tighten pressure screw.

# SACC-M12MS-5CON-PG11 SH - Connector

1403854

<https://www.phoenixcontact.com/us/products/1403854>

Schematic diagram

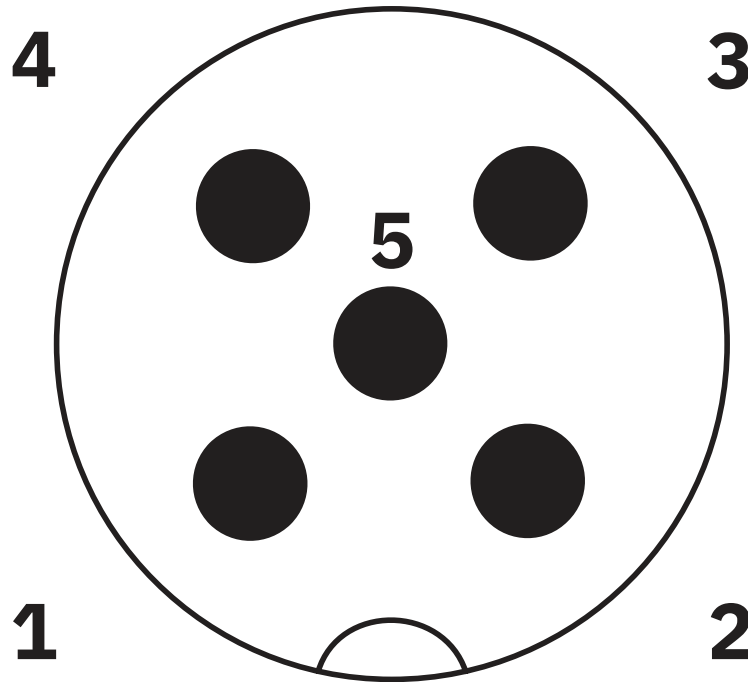

Pin assignment M12 male connector, 5-pos., A-coded, male side

Dimensional drawing

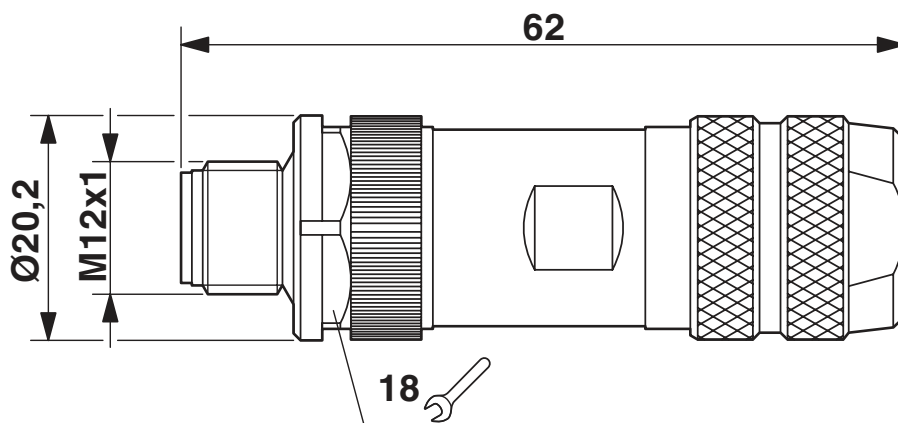

Plug, M12 x 1, straight, shielded

# SACC-M12MS-5CON-PG11 SH - Connector



1403854

<https://www.phoenixcontact.com/us/products/1403854>

## Classifications

### ECLASS

ECLASS-11.0	27440102
ECLASS-12.0	27440116
ECLASS-13.0	27440116

### ETIM

ETIM 8.0	EC002635
----------	----------

### UNSPSC

UNSPSC 21.0	39121400
-------------	----------



# SACC-M12MS-5CON-PG11 SH - Connector



1403854

<https://www.phoenixcontact.com/us/products/1403854>

## Environmental product compliance

REACH SVHC	Lead 7439-92-1
China RoHS	Environmentally Friendly Use Period = 50 years
	For information on hazardous substances, refer to the manufacturer's declaration available under "Downloads"

# SACC-M12MS-5CON-PG11 SH - Connector



1403854

<https://www.phoenixcontact.com/us/products/1403854>

## Accessories

### PROT-M12 FS-PA-CHAIN - Sealing cap

1430873

<https://www.phoenixcontact.com/us/products/1430873>

M12 sealing cap made of plastic with fixing band, for sensor cables, for free M12 plugs



---

### A 0,25- 5 - Ferrule

3202465

<https://www.phoenixcontact.com/us/products/3202465>

Ferrule, length: 5 mm, color: silver



# SACC-M12MS-5CON-PG11 SH - Connector

1403854

<https://www.phoenixcontact.com/us/products/1403854>

## TSD 04 SAC - Torque screwdriver

1208429

<https://www.phoenixcontact.com/us/products/1208429>



Torque screwdriver, with preset torque of 0.4 Nm and 4 mm hexagonal drive for M12 connectors

---

## SACC BIT M12-D20 - Tool

1208445

<https://www.phoenixcontact.com/us/products/1208445>



Nut for assembling M12 connectors for assembly with a knurl diameter of 20 mm, for 4 mm hexagonal drive

# SACC-M12MS-5CON-PG11 SH - Connector



1403854

<https://www.phoenixcontact.com/us/products/1403854>

## TSD-M 1,2NM - Torque screwdriver

1212224

<https://www.phoenixcontact.com/us/products/1212224>



Torque screw driver, accuracy as per EN ISO 6789 standard, adjustable from 0.3 - 1.2 Nm

---

## TSD-M SAC-BIT ADAPTER - Adapter insert

1212600

<https://www.phoenixcontact.com/us/products/1212600>



Adapter bit for TSD-M...torque tools, E6.3-1/4" drive with 4 mm hexagon to accommodate SAC bits

# SACC-M12MS-5CON-PG11 SH - Connector



1403854

<https://www.phoenixcontact.com/us/products/1403854>

## CRIMPFOX 6H - Crimping pliers

1212046

<https://www.phoenixcontact.com/us/products/1212046>



Crimping pliers, for ferrules without insulating collar according to DIN 46228 Part 1 and ferrules with insulating collar according to DIN 46228 Part 4, 0.14 mm<sup>2</sup> ... 6 mm<sup>2</sup>, unlockable pressure lock, lateral entry

---

## VS-CABLE-STRIP-VARIO - Stripping tool

1657407

<https://www.phoenixcontact.com/us/products/1657407>

Stripping tool, for the multi-level stripping of shielded cables



# SACC-M12MS-5CON-PG11 SH - Connector



1403854

<https://www.phoenixcontact.com/us/products/1403854>

## SZF 1-0,6X3,5 - Screwdriver

1204517

<https://www.phoenixcontact.com/us/products/1204517>



Actuation tool, for ST terminal blocks, also suitable for use as a bladed screwdriver, size: 0.6 x 3.5 x 100 mm, 2-component grip, with non-slip grip

---

Phoenix Contact 2023 © - all rights reserved

<https://www.phoenixcontact.com>

Phoenix Contact USA  
586 Fulling Mill Road  
Middletown, PA 17057, United States  
(+717) 944-1300  
[info@phoenixcon.com](mailto:info@phoenixcon.com)