

AMGP-6552

37 – 43.5 GHz Low Noise Down-Converter
in SMT Package



Data Sheet



Description

The AMGP-6552 is a broadband down-converter that combines a low noise amplifier and a sub-harmonic image reject mixer. It is housed in a 5 x 5 mm surface mount package designed for use in applications between 37 GHz and 43.5 GHz. Over the frequency range from 40.5 to 43.5 GHz, it provides 12 dB typical down-conversion gain with 50 Ω RF & LO match. The required LO power is 17 dBm. The typical input third order intercept point is -6 dBm and Noise Figure is typically 5 dB.

Features

- 5 x 5 mm surface mount package
- RF frequency range from 37 to 43.5 GHz
- LO frequency range from 16.75 to 23.5 GHz
- IF frequency range from DC to 3 GHz
- +17 dBm LO driver power
- 12 dB Conversion Gain
- -4.3 dBm Input IP3 @ 4 0.5 GHz, and -8.7 dBm @ 43.5 GHz
- Vdd = 3 V and Idd = 100 mA

Functional Block Diagram

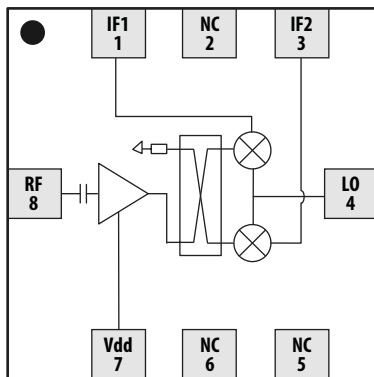

Pin	Function
1	IF1
2	NC
3	IF2
4	LO
5	NC
6	NC
7	Vdd
8	RF_IN

Application

- Microwave Radio Systems

Package Diagram

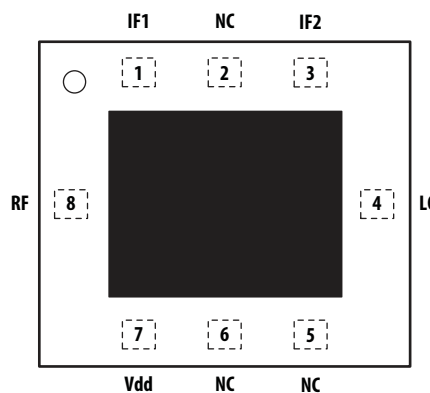

Attention: Observe Precautions for handling electrostatic sensitive devices.
ESD Machine Model: 40 V
ESD Human Body Model: 200 V
Refer to Avago Application Note A004R: Electrostatic Discharge Damage and Control.

ELECTRICAL SPECIFICATIONS

Table 1. Absolute Minimum and Maximum Ratings

Parameter		Specifications			Comments
Description		Min.	Max.	Unit	
Supply Voltage	Vdd		6	V	
RF Input Power	RF		0	dBm	
MSL			MSL2		
Channel Temperature			150	°C	
Storage Temperature		-45	150	°C	

Table 2. Recommended Operating Range

Parameter		Specifications				
Description	Pin	Min.	Typical	Max.	Unit	Comments
Supply Voltage	Vd1		3	4	V	
Frequency Range	RF	37		43.5	GHz	
	LO	17		23.25		
	IF	DC		3		
LO Power		15		17	dBm	
Bias Current			97		mA	
Thermal Resistance, θ_{ch-b}			36.7		°C/W	
Case Temperature		-40		+85	°C	
ESD	Human Body Model		200		V	
	Machine Model		40		V	

Table 3. RF Electrical Characteristics

All data measured on a Taconic RF-35A2 demo board at Vdd = 3 V, T_A = 25° C, IF = 1 GHz, LO = 17 dBm, Lower Side Band (RF + IF = 2*LO) and 50 Ω at all ports, unless otherwise specified.

Parameter		Performance			Unit	Comments
		Min.	Typical	Max.		
RF Return Loss			-12		dB	
Conversion Gain	RF = 40.5 GHz	10.5	12.1		dB	
	RF = 42.0 GHz		11.8			
	RF = 43.5 GHz		12.6			
Noise Figure	RF = 40.5 GHz		4.8	6.0	dB	
	RF = 42.0 GHz		4.7			
	RF = 43.5 GHz		5			
Input IP3	RF = 40.5 GHz	-9	-4.3		dBm	RF power = -30 dBm/tone, with Δf = 10 MHz
	RF = 42.0 GHz	-9	-5.8			
	RF = 43.5 GHz	-10	-8.7			
C/I (IF/2 Suppression)			54		dBc	RF Power = -30 dBm
Image Rejection Ratio	RF = 40.5 GHz	12.5	17.2		dB	
	RF = 42.0 GHz		19.5			
	RF = 43.5 GHz		20.2			
LO Return Loss			-12		dB	LO power = 17 dBm
IF Return Loss			-12		dB	LO power = 17 dBm

Note: Conversion Gain, Noise Figure, Input IP3 and Image Rejection Ratio measurement accuracy is subjected to the tolerance of ± 0.2 dB, ± 0.2 dB, ± 0.2 dBm & ± 0.5 dB respectively.

**Product Consistency Distribution Charts at 40.5 GHz, 42 GHz and 43.5 GHz, Vdd = 3 V, IF = 1 GHz, LO = 17 dBm
(Sample size of 2,400 pieces)**

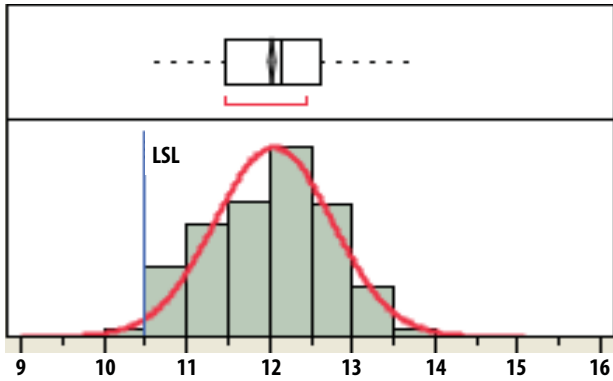

CGain @ 40.5 GHz, Mean = 12.1 dB, LSL = 10.5 dB

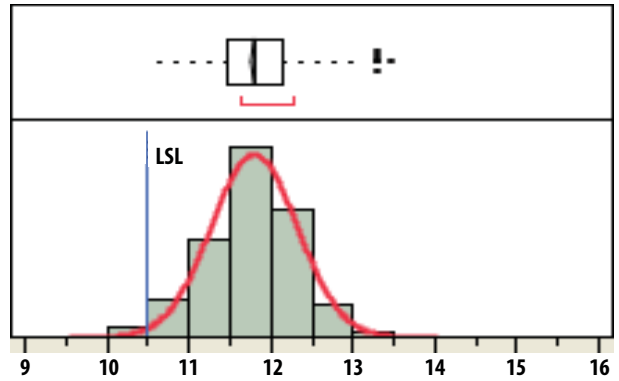

CGain @ 42 GHz, Mean = 11.8 dB, LSL = 10.5 dB

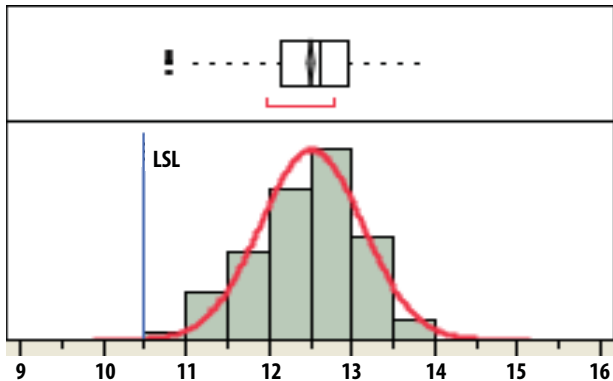

CGain @ 43.5 GHz, Mean = 12.6 dB, LSL = 10.5 dB

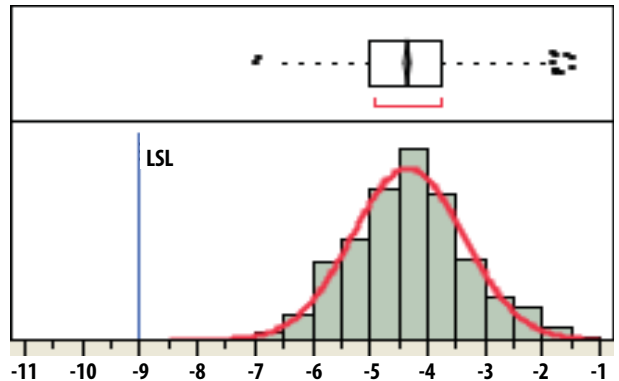

IIP3 @ 40.5 GHz, Mean = -4.3 dBm, LSL = -9 dBm

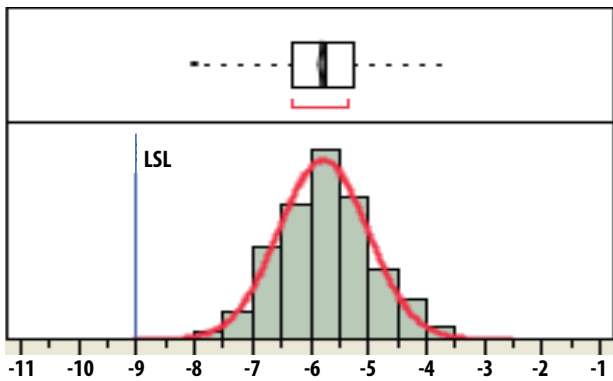

IIP3 @ 42 GHz, Mean = -5.8 dBm, LSL = -9 dBm

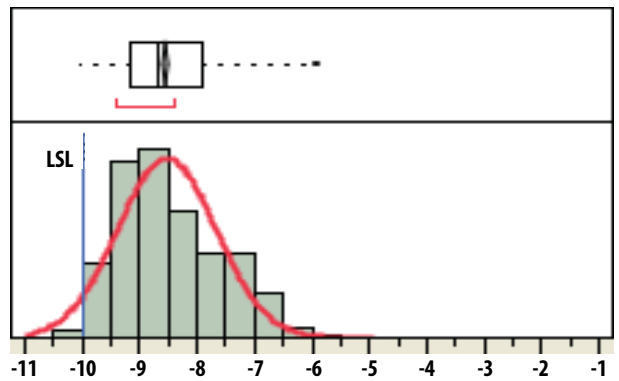

IIP3 @ 43.5 GHz, Mean = -8.7 dBm, LSL = -10 dBm

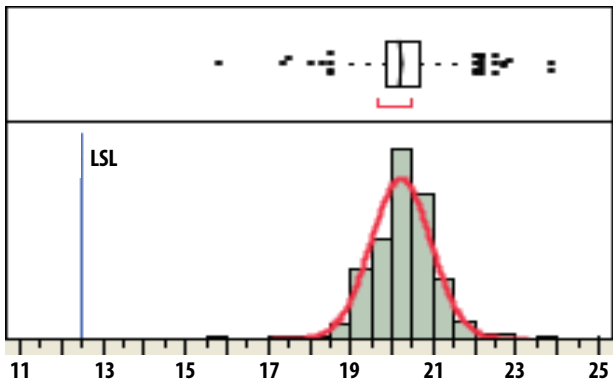

Image Rejection Ratio @ 40.5 GHz, Mean = 17.2 dB, LSL = 12.5 dB

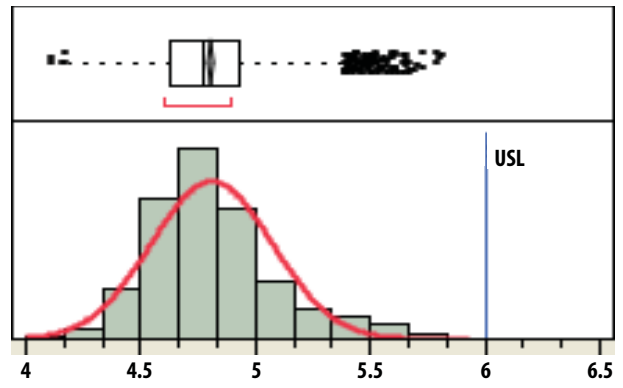

Image Rejection Ratio CGain @ 42 GHz, Mean = 19.5 dB, LSL = 12.5 dB

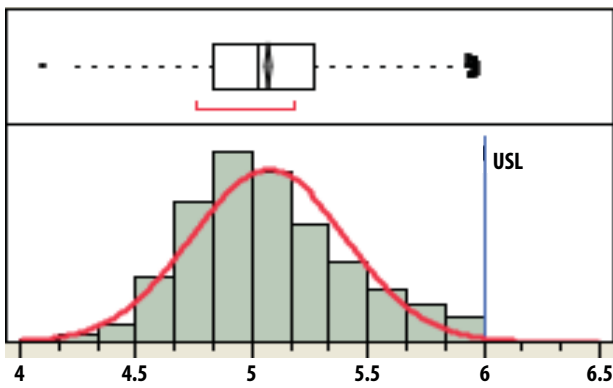
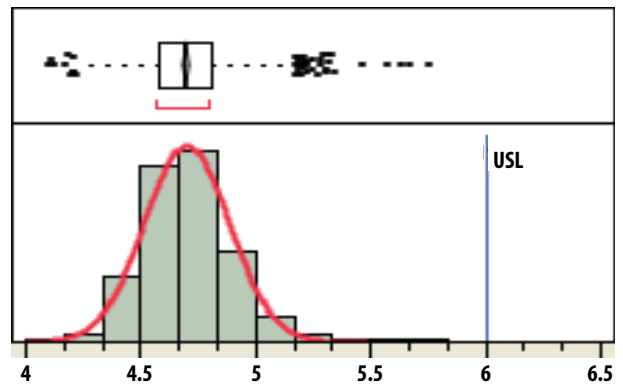
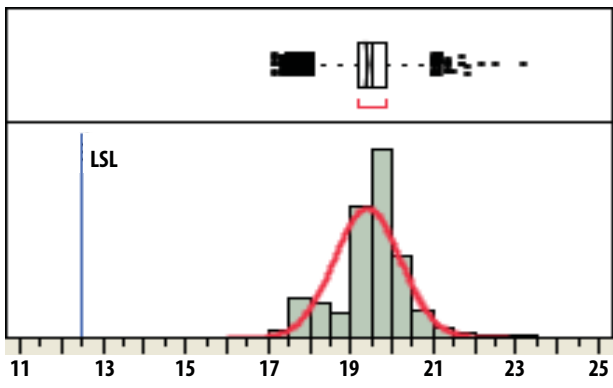

Image Rejection Ratio @ 43.5 GHz, Mean = 20.2 dB, LSL = 12.5 dB



NF @ 40.5 GHz, Mean = 4.8 dB, USL = 6 dB



NF @ 42 GHz, Mean = 4.7 dB, USL = 6 dB

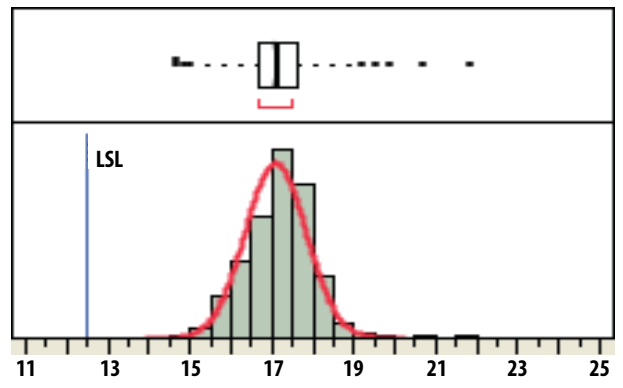

NF @ 43.5 GHz, Mean = 5 dB, USL = 6 dB

Performance plots (Typical @ 25° C)

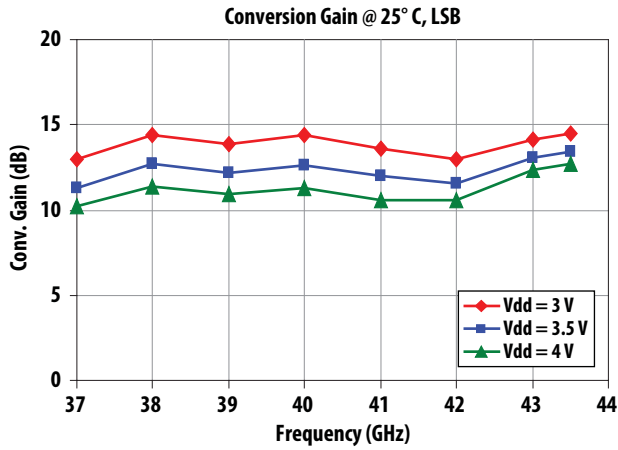

Figure 1. Conversion Gain at 25° C over Vdd, Lower Side Band

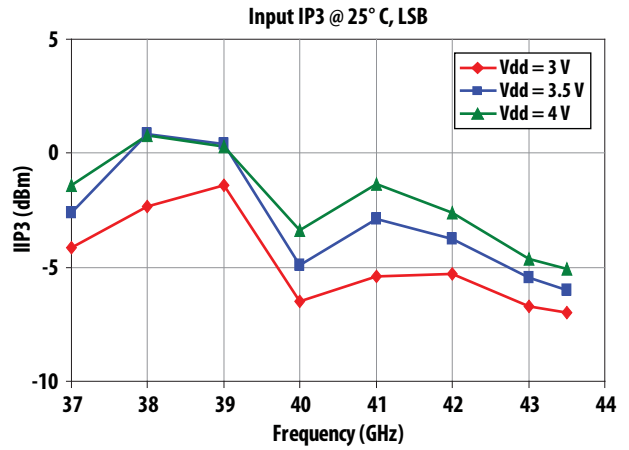

Figure 2. Input IP3 at 25° C over Vdd, Lower Side Band

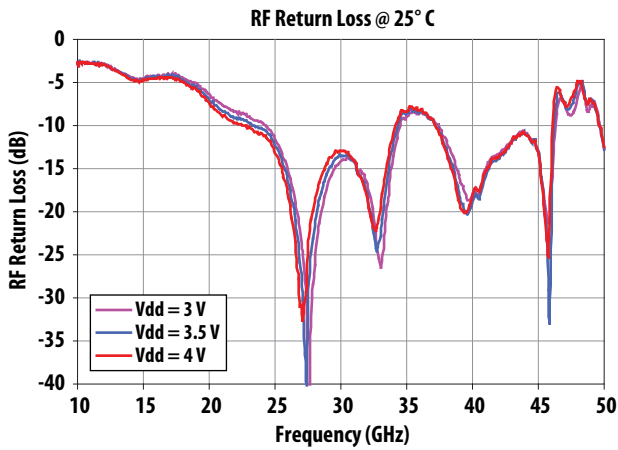

Figure 3. RF Return Loss at 25° C over Vdd

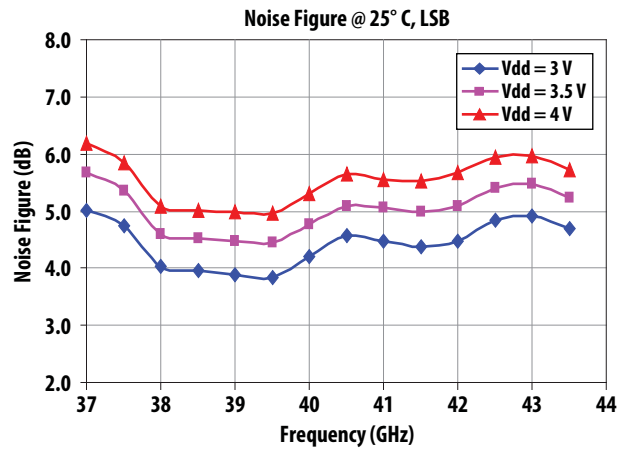

Figure 4. Noise Figure at 25° C over Vdd, Lower Side Band

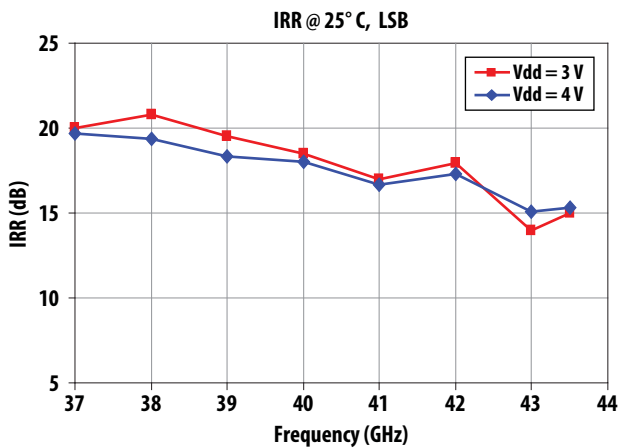

Figure 5. Receiver Image Rejection Ratio @ 25° C over Vdd

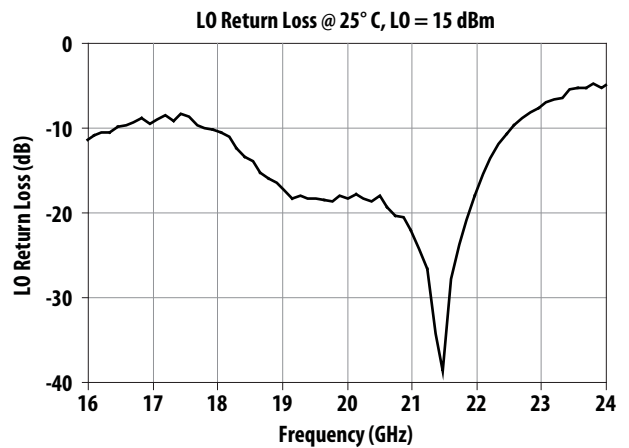

Figure 6. LO Return Loss at 25° C, LO = 15 dBm

Performance plots (USB vs. LSB; LO power)

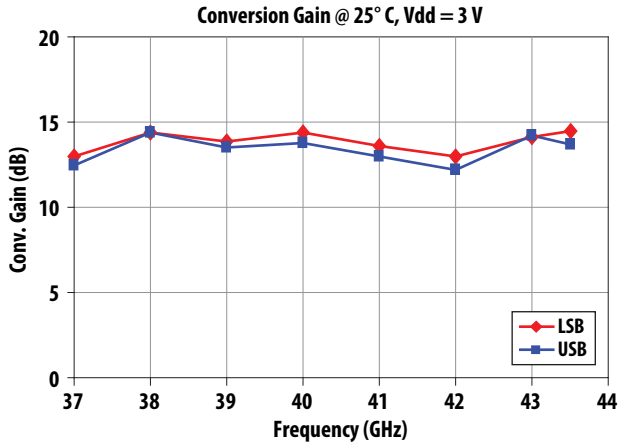

Figure 7. Conversion Gain at 25°C, Vdd = 3 V LSB and USB

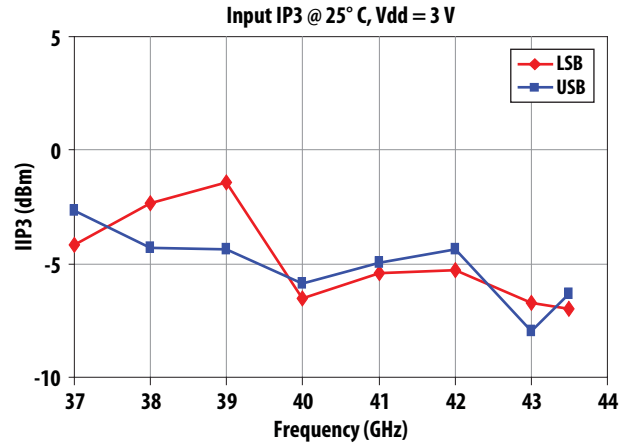

Figure 8. Input IP3 at 25°C, Vdd = 3 V, LSB and USB

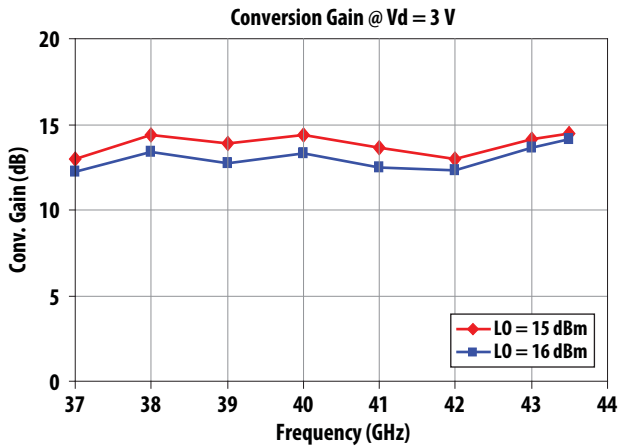

Figure 9. Conversion Gain @ 25°C, Vdd = 3 V, vs. LO Power

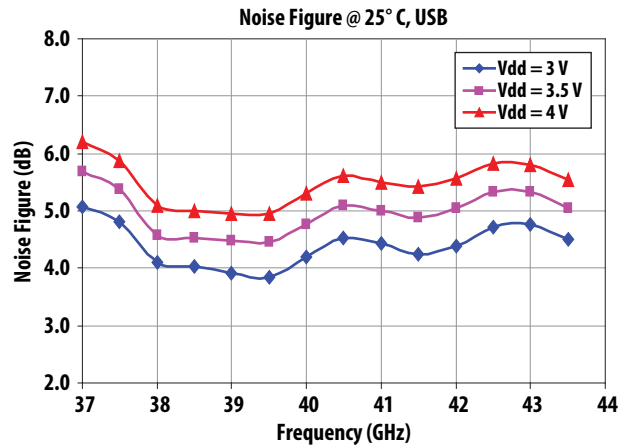

Figure 10. Noise Figure at 25°C over Vdd, Upper Side Band

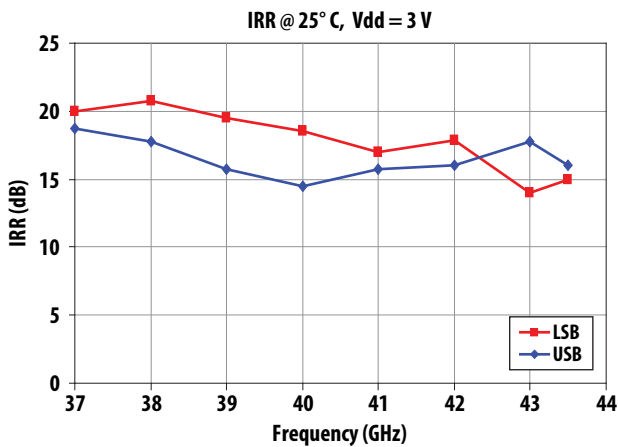

Figure 11. Image Rejection Ratio @ 25°C, Vdd = 3 V, LSB and USB

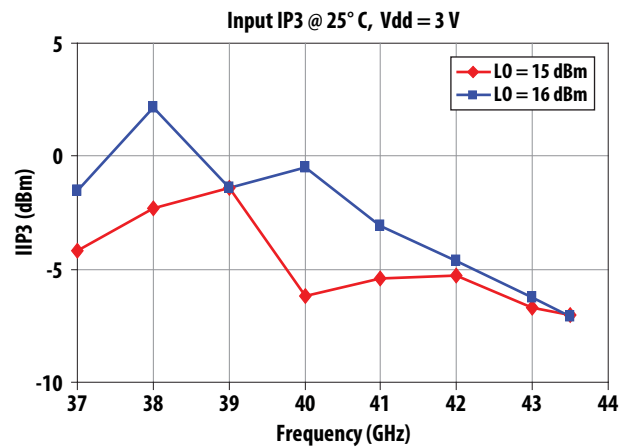

Figure 12. Input IP3 @ 25°C, Vdd = 3 V, vs. LO Power

Performance plots (Over Temp, LSB)

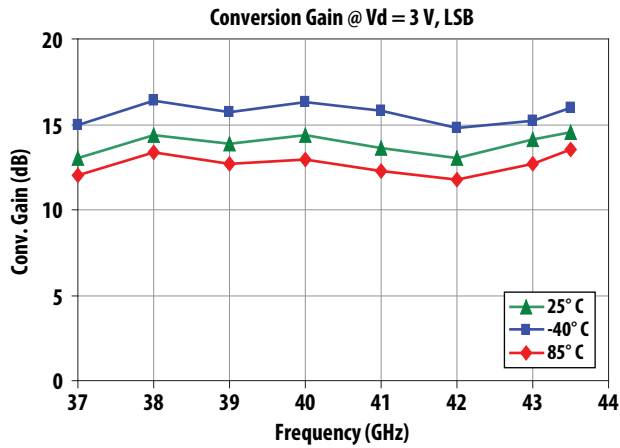

Figure 13. Conversion Gain, Vdd = 3 V, LSB Over Temperature

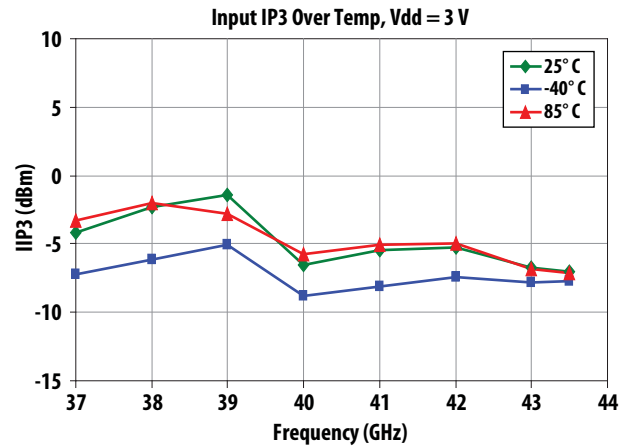

Figure 14. Input IP3, Vdd = 3 V, LSB Over Temperature

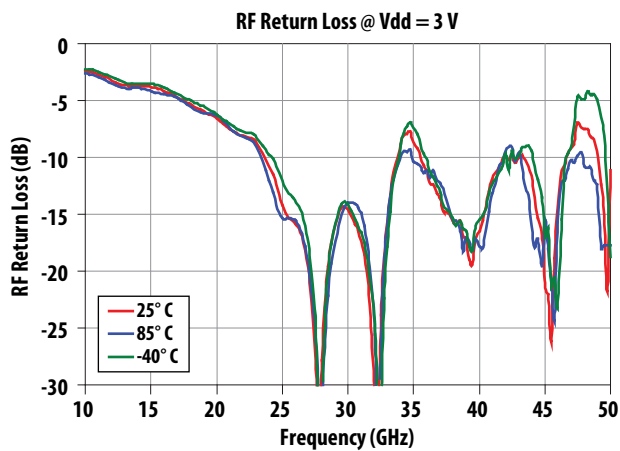

Figure 15. RF Return Loss, Vdd = 3 V Over Temperature

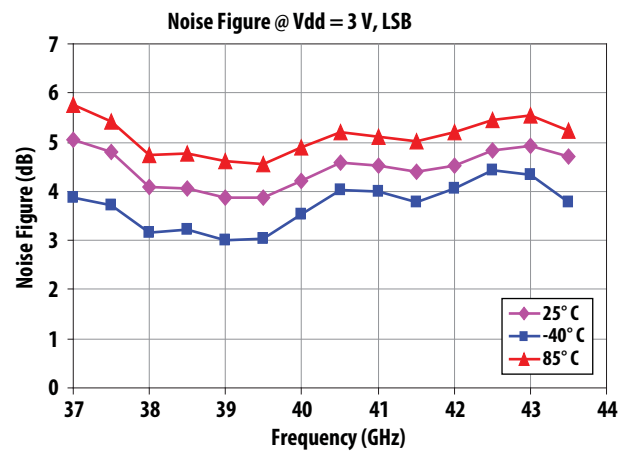

Figure 16. Noise Figure, Vdd = 3 V, LSB Over Temperature

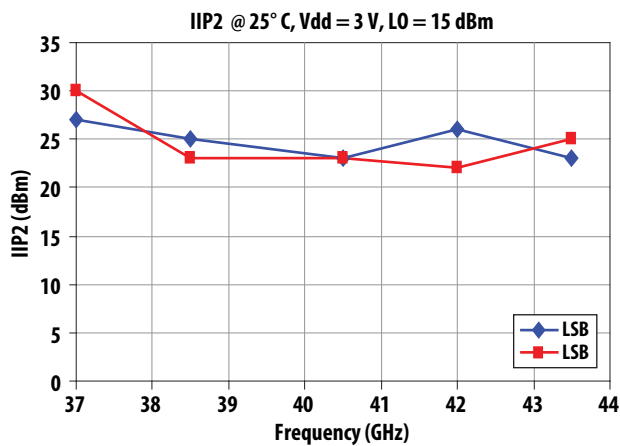

Figure 17. Input IP2 @ 25°C, Vdd = 3 V, LO = 15 dBm and RF Power = -30 dBm

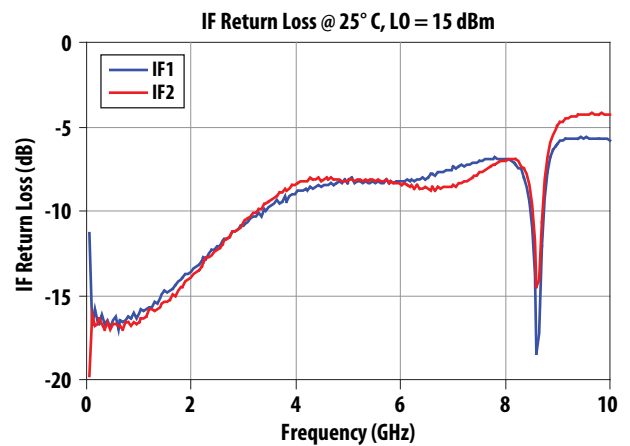

Figure 18. IF Return Loss @ 25°C, LO = 15 dBm

Evaluation Board Description

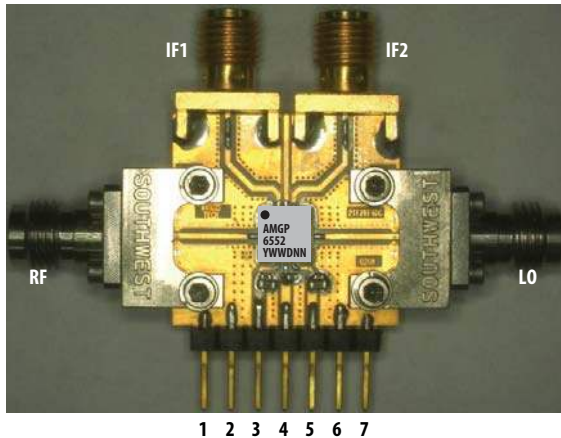
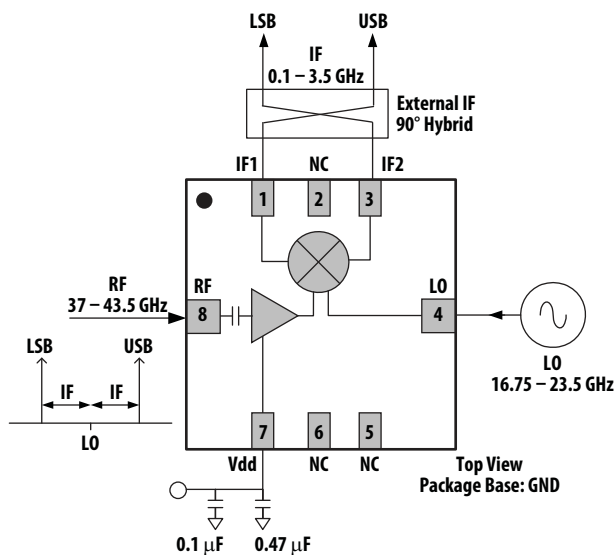

Table 4. Pin Description

Pin No.	Function	Biasing	Comment
1	Gnd		
2	Gnd		
3	Vdd	3 V	97 mA (measured current)
4	NC		
5	NC		
6	Gnd		
7	Gnd		
LO	LO	15 dBm	

Demo board circuit for AMGP-6552



Biasing and Operation

For most applications, the recommended DC bias condition for the Low Noise Amplifier (LNA) should be set at $V_{DD} = 3\text{ V}$ with 97 mA. In this bias condition, the down-converter will provide the best compromise for conversion gain, overall NF and linearity. If higher linearity (IIP3) is desired, V_{DD} should be at 3.5 V or 4 V. This higher bias voltage of the LNA will result in slightly higher NF and lower conversion gain.

One variable that strongly affects conversion gain and linearity is the LO input power. The typical operating range for LO input power is from 15 dBm to 17 dBm. The lower the LO input power, the higher the conversion gain and the lower overall linearity and vice versa; the higher the LO input power, the lower the conversion and the higher overall linearity. Depending on the applications, the LO input power and the LNA bias voltage can be selected to obtain desired performance.

Package Dimension, PCB Layout and Tape and Reel information

Please refer to Avago Technologies Application Note 5521, AMxP-xxxx production Assembly Process (Land Pattern B).

Part Number Ordering Information

Part Number	Devices per Container	Container
AMGP-6552-BLKG	10	antistatic bag
AMGP-6552-TR1G	100	7" Reel
AMGP-6552-TR2G	500	7" Reel

For product information and a complete list of distributors, please go to our web site: www.avagotech.com

Avago, Avago Technologies, and the A logo are trademarks of Avago Technologies in the United States and other countries. Data subject to change. Copyright © 2005-2012 Avago Technologies. All rights reserved. AV02-3212EN - May 10, 2012

AVAGO
TECHNOLOGIES