

IRF6604

HEXFET® Power MOSFET

- Application Specific MOSFETs
- Ideal for CPU Core DC-DC Converters
- Low Conduction Losses
- Low Switching Losses
- Low Profile (<0.7 mm)
- Dual Sided Cooling Compatible
- Compatible with existing Surface Mount Techniques

V_{DS}	$R_{DS(on)}$ max	Q_g
30V	11.5m Ω @ $V_{GS} = 7.0V$	17nC
	13m Ω @ $V_{GS} = 4.5V$	

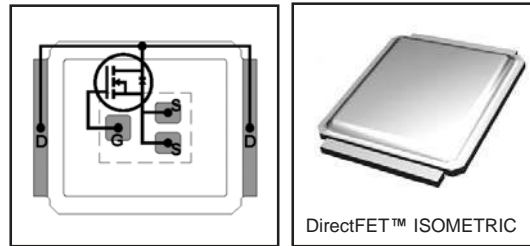

Description

The IRF6604 combines the latest HEXFET® Power MOSFET Silicon technology with the advanced DirectFET™ packaging to achieve the lowest on-state resistance charge product in a package that has the footprint of an SO-8 and only 0.7 mm profile. The DirectFET package is compatible with existing layout geometries used in power applications, PCB assembly equipment and vapor phase, infra-red or convection soldering techniques. The DirectFET package allows dual sided cooling to maximize thermal transfer in power systems, IMPROVING previous best thermal resistance by 80%.

The IRF6604 balances both low resistance and low charge along with ultra low package inductance to reduce both conduction and switching losses. The reduced total losses make this product ideal for high efficiency DC-DC converters that power the latest generation of processors operating at higher frequencies. The IRF6604 has been optimized for parameters that are critical in synchronous buck converters including $R_{ds(on)}$ and gate charge to minimize losses in the control FET socket.

Absolute Maximum Ratings

	Parameter	Max.	Units
V_{DS}	Drain-to-Source Voltage	30	V
V_{GS}	Gate-to-Source Voltage	± 12	
I_D @ $T_C = 25^\circ C$	Continuous Drain Current, V_{GS} @ 7.0V	49	A
I_D @ $T_A = 25^\circ C$	Continuous Drain Current, V_{GS} @ 7.0V	12	
I_D @ $T_A = 70^\circ C$	Continuous Drain Current, V_{GS} @ 7.0V	9.2	
I_{DM}	Pulsed Drain Current ^①	92	
P_D @ $T_A = 25^\circ C$	Power Dissipation ^②	2.3	W
P_D @ $T_A = 70^\circ C$	Power Dissipation ^②	1.5	
P_D @ $T_C = 25^\circ C$	Power Dissipation	42	
	Linear Derating Factor	0.018	W/ $^\circ C$
T_J	Operating Junction and	-40 to + 150	$^\circ C$
T_{STG}	Storage Temperature Range		

Thermal Resistance

	Parameter	Typ.	Max.	Units
$R_{\theta JA}$	Junction-to-Ambient ^④	—	55	$^\circ C/W$
$R_{\theta JA}$	Junction-to-Ambient ^⑤	12.5	—	
$R_{\theta JA}$	Junction-to-Ambient ^⑥	20	—	
$R_{\theta JC}$	Junction-to-Case ^⑦	—	3.0	
$R_{\theta J-PCB}$	Junction-to-PCB Mounted	1.0	—	

Notes ^① through ^⑦ are on page 11

www.irf.com

IRF6604

International
IR Rectifier

Static @ $T_J = 25^\circ\text{C}$ (unless otherwise specified)

	Parameter	Min.	Typ.	Max.	Units	Conditions
BV_{DSS}	Drain-to-Source Breakdown Voltage	30	—	—	V	$V_{GS} = 0V, I_D = 250\mu A$
$\Delta BV_{DSS}/\Delta T_J$	Breakdown Voltage Temp. Coefficient	—	27	—	mV/°C	Reference to $25^\circ\text{C}, I_D = 1mA$
$R_{DS(on)}$	Static Drain-to-Source On-Resistance	—	9.0	11.5	m Ω	$V_{GS} = 7.0V, I_D = 12A$ ③
		—	10	13		$V_{GS} = 4.5V, I_D = 9.6A$ ③
$V_{GS(th)}$	Gate Threshold Voltage	1.0	—	3.0	V	$V_{DS} = V_{GS}, I_D = 250\mu A$
$\Delta V_{GS(th)}/\Delta T_J$	Gate Threshold Voltage Coefficient	—	-4.5	—	mV/°C	
I_{DSS}	Drain-to-Source Leakage Current	—	—	30	μA	$V_{DS} = 24V, V_{GS} = 0V$
		—	—	100		$V_{DS} = 24V, V_{GS} = 0V, T_J = 125^\circ\text{C}$
I_{GSS}	Gate-to-Source Forward Leakage	—	—	100	nA	$V_{GS} = 12V$
	Gate-to-Source Reverse Leakage	—	—	-100		$V_{GS} = -12V$
g_{fs}	Forward Transconductance	38	—	—	S	$V_{DS} = 15V, I_D = 9.6A$
Q_g	Total Gate Charge	—	17	26	nC	$V_{DS} = 15V$ $V_{GS} = 4.5V$ $I_D = 9.6A$ See Fig. 16
Q_{gs1}	Pre-V _{th} Gate-to-Source Charge	—	4.1	—		
Q_{gs2}	Post-V _{th} Gate-to-Source Charge	—	1.0	—		
Q_{gd}	Gate-to-Drain Charge	—	6.3	—		
Q_{godr}	Gate Charge Overdrive	—	5.6	—		
Q_{sw}	Switch Charge ($Q_{gs2} + Q_{gd}$)	—	7.3	—		
Q_{oss}	Output Charge	—	9.5	—	nC	$V_{DS} = 16V, V_{GS} = 0V$
$t_{d(on)}$	Turn-On Delay Time	—	11	—	ns	$V_{DD} = 15V, V_{GS} = 4.5V$ ③ $I_D = 9.6A$ Clamped Inductive Load
t_r	Rise Time	—	4.3	—		
$t_{d(off)}$	Turn-Off Delay Time	—	18	—		
t_f	Fall Time	—	25	—		
C_{iss}	Input Capacitance	—	2270	—	pF	$V_{GS} = 0V$ $V_{DS} = 15V$ $f = 1.0MHz$
C_{oss}	Output Capacitance	—	420	—		
C_{rss}	Reverse Transfer Capacitance	—	190	—		

Avalanche Characteristics

	Parameter	Typ.	Max.	Units
E_{AS}	Single Pulse Avalanche Energy ②	—	32	mJ
I_{AR}	Avalanche Current ①	—	9.6	A
E_{AR}	Repetitive Avalanche Energy ①	—	0.23	mJ

Diode Characteristics

	Parameter	Min.	Typ.	Max.	Units	Conditions
I_S	Continuous Source Current (Body Diode)	—	—	12	A	MOSFET symbol showing the integral reverse p-n junction diode.
I_{SM}	Pulsed Source Current (Body Diode) ①	—	—	92		
V_{SD}	Diode Forward Voltage	—	0.94	1.2	V	$T_J = 25^\circ\text{C}, I_S = 9.6A, V_{GS} = 0V$ ③
t_{rr}	Reverse Recovery Time	—	31	47	ns	$T_J = 25^\circ\text{C}, I_F = 9.6A$
Q_{rr}	Reverse Recovery Charge	—	26	39	nC	$di/dt = 100A/\mu s$ ③
t_{on}	Forward Turn-On Time	Intrinsic turn-on time is negligible (turn-on is dominated by LS+LD)				

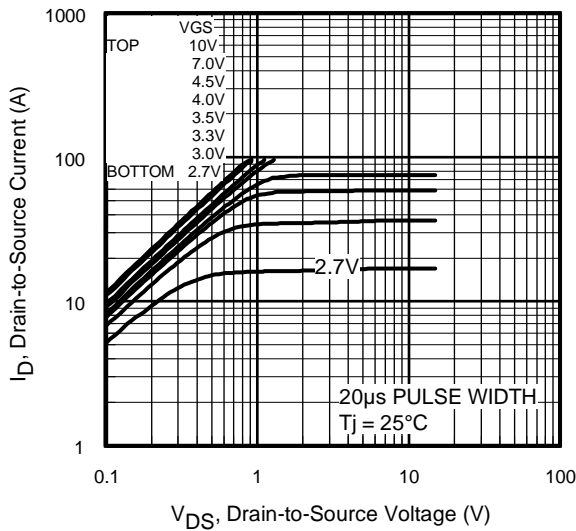

Fig 1. Typical Output Characteristics

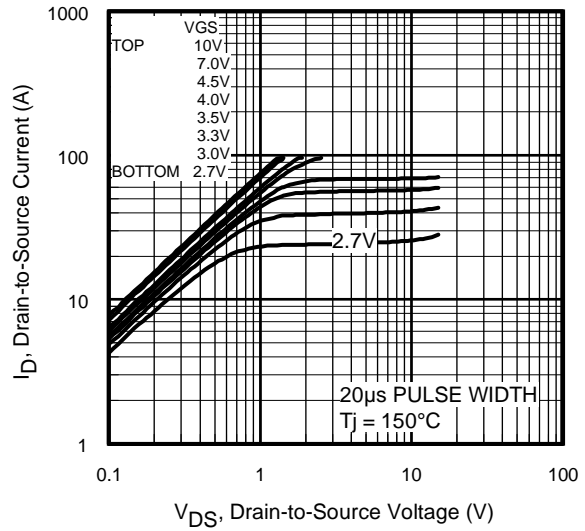

Fig 2. Typical Output Characteristics

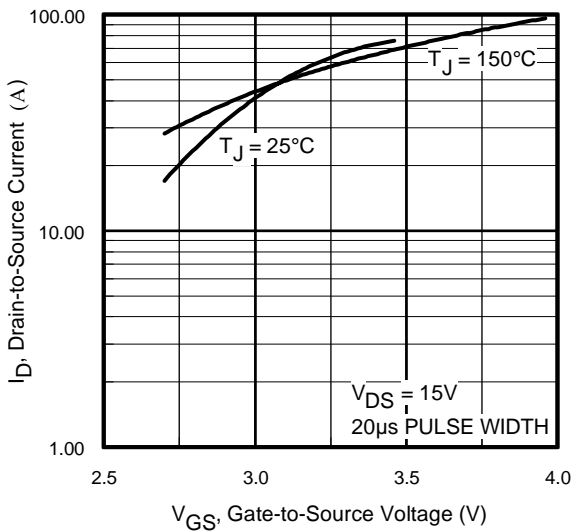

Fig 3. Typical Transfer Characteristics

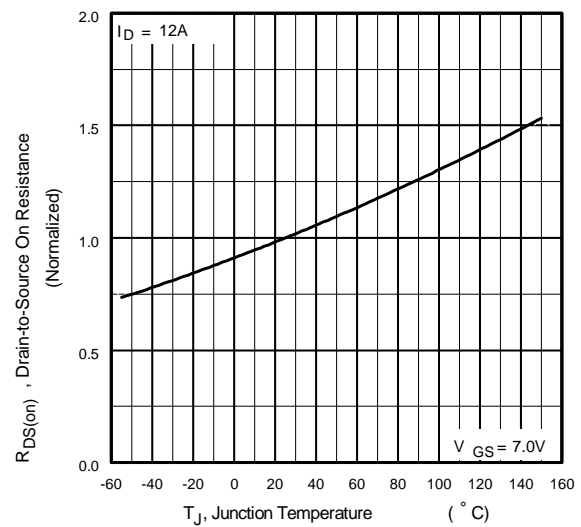

Fig 4. Normalized On-Resistance Vs. Temperature

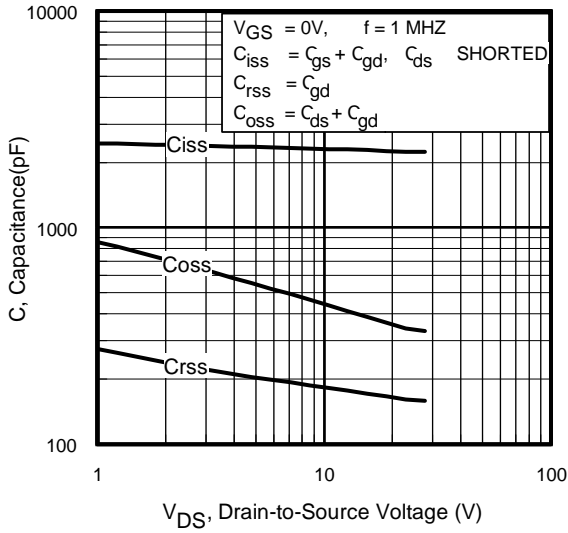

Fig 5. Typical Capacitance Vs. Drain-to-Source Voltage

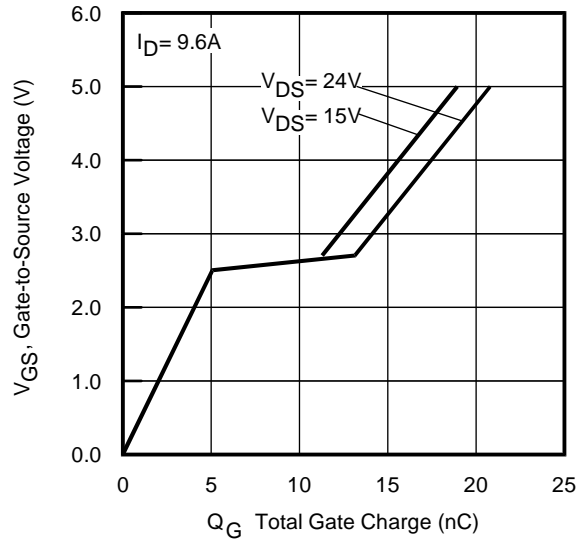

Fig 6. Typical Gate Charge Vs. Gate-to-Source Voltage

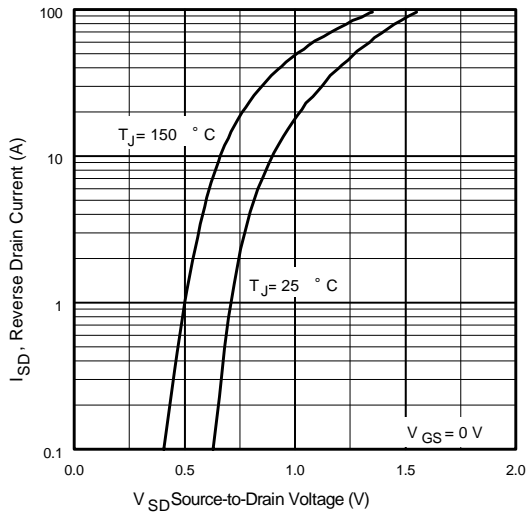

Fig 7. Typical Source-Drain Diode Forward Voltage

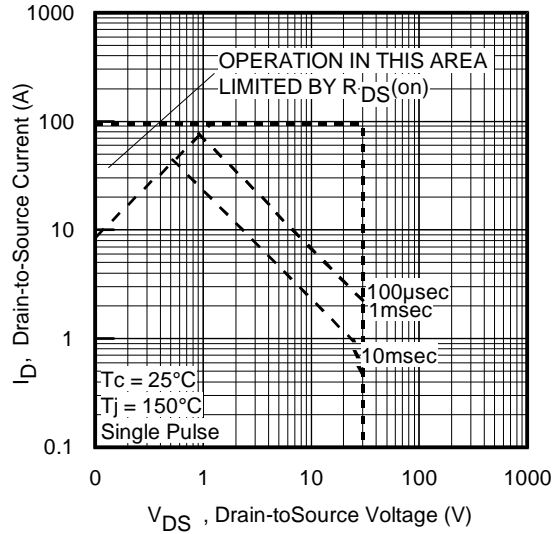

Fig 8. Maximum Safe Operating Area

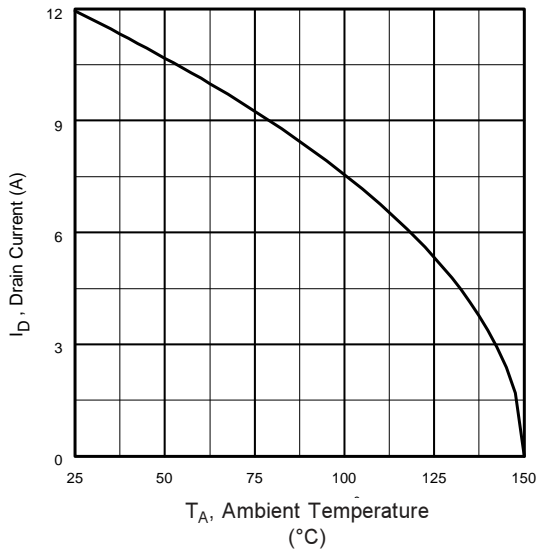

Fig 9. Maximum Drain Current Vs. Ambient Temperature

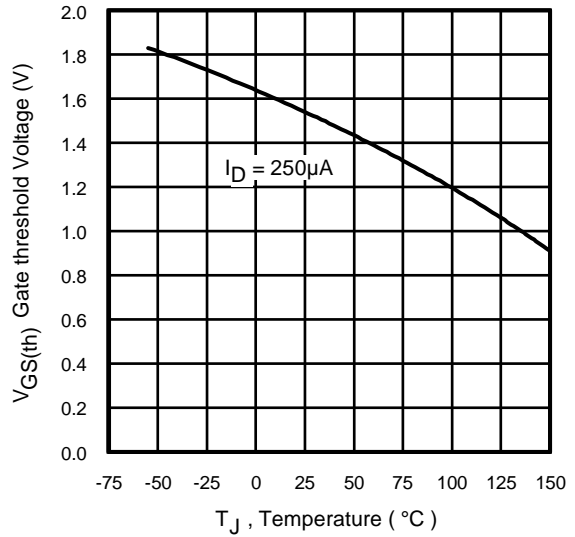

Fig 10. Threshold Voltage Vs. Temperature

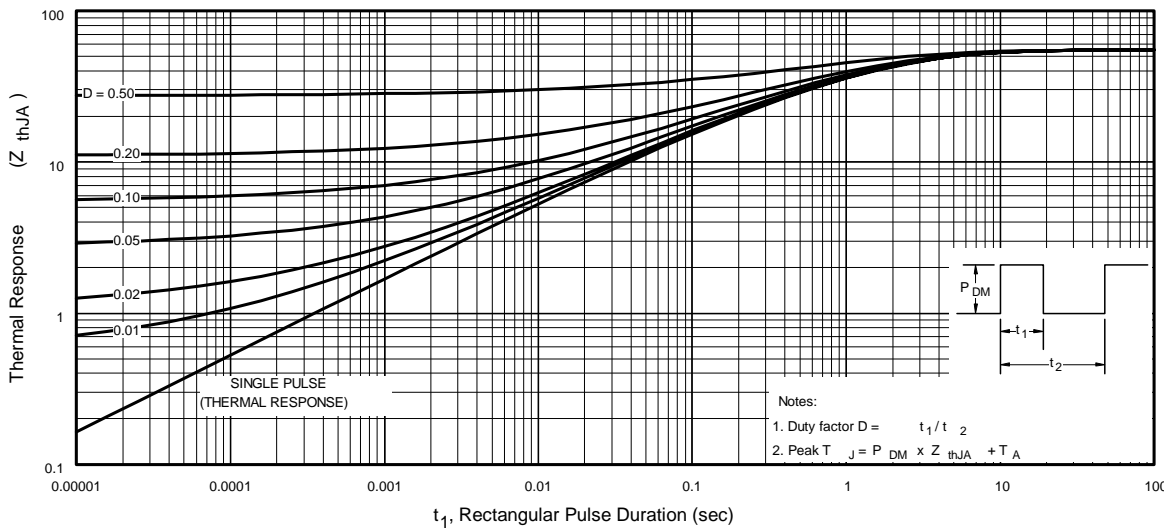

Fig 11. Maximum Effective Transient Thermal Impedance, Junction-to-Ambient

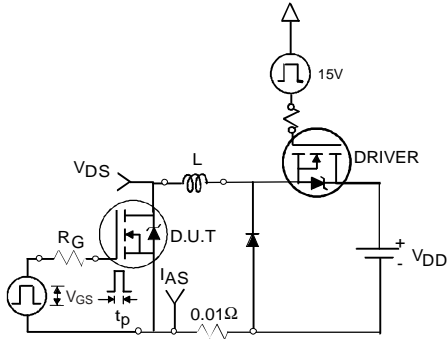

Fig 12a. Unclamped Inductive Test Circuit

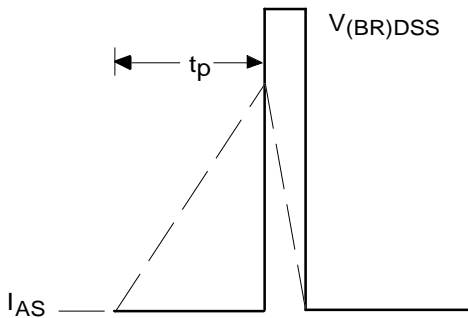

Fig 12b. Unclamped Inductive Waveforms

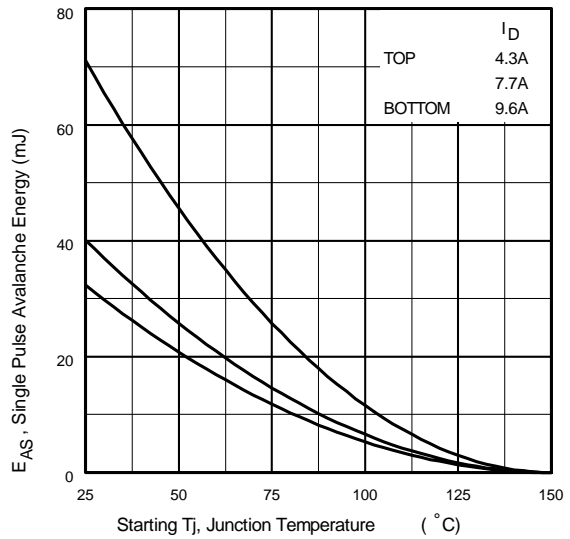

Fig 12c. Maximum Avalanche Energy Vs. Drain Current

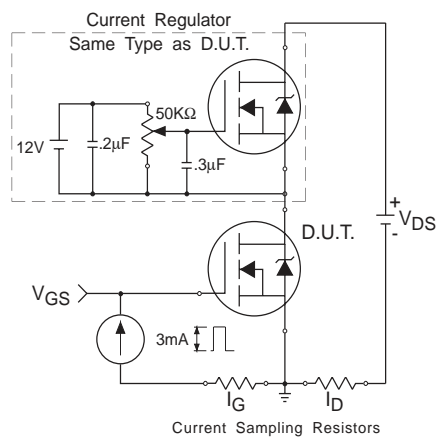

Fig 13. Gate Charge Test Circuit

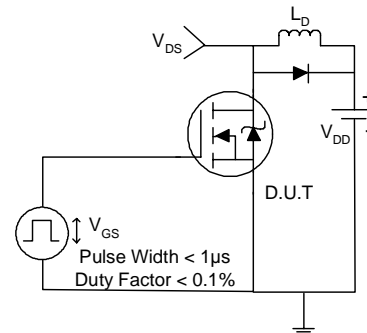

Fig 14a. Switching Time Test Circuit

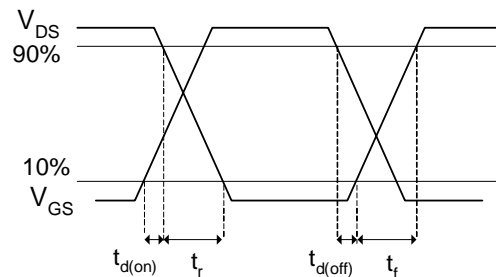

Fig 14b. Switching Time Waveforms

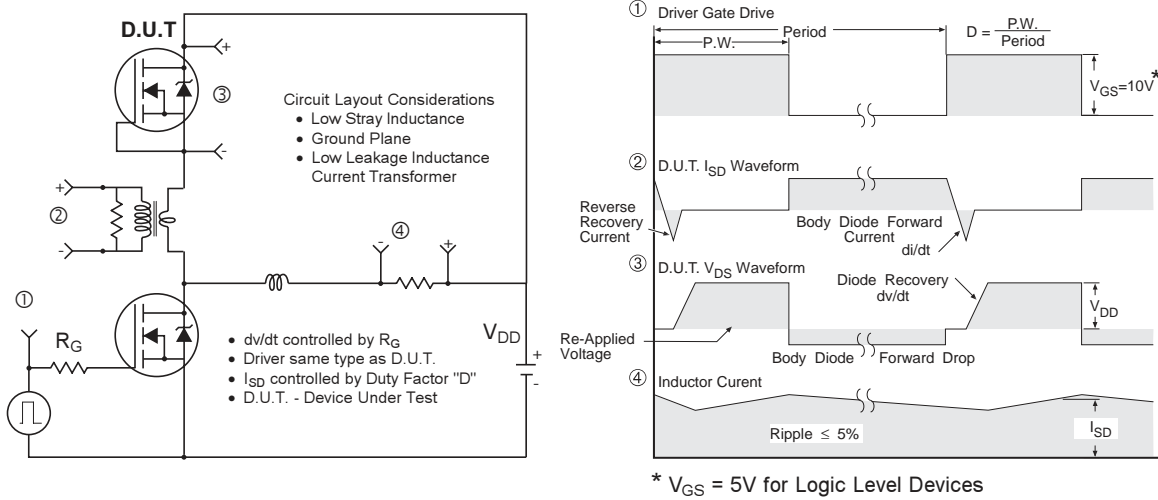

Fig 15. Peak Diode Recovery dv/dt Test Circuit for N-Channel HEXFET® Power MOSFETS

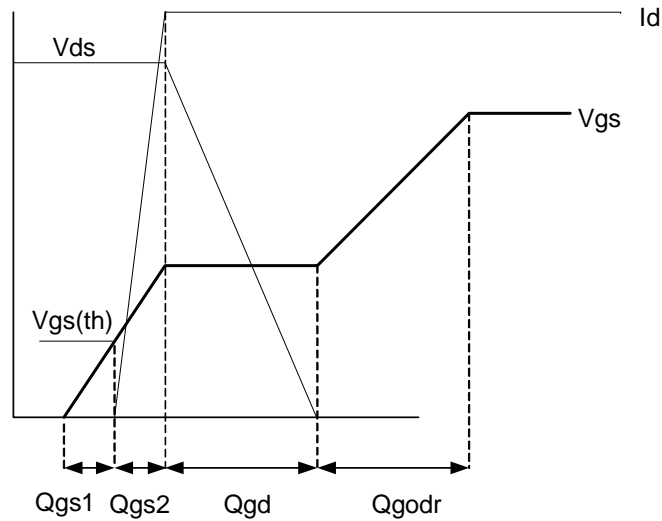

Fig 16. Gate Charge Waveform

Power MOSFET Selection for Non-Isolated DC/DC Converters

Control FET

Special attention has been given to the power losses in the switching elements of the circuit - Q1 and Q2. Power losses in the high side switch Q1, also called the Control FET, are impacted by the $R_{ds(on)}$ of the MOSFET, but these conduction losses are only about one half of the total losses.

Power losses in the control switch Q1 are given by;

$$P_{loss} = P_{conduction} + P_{switching} + P_{drive} + P_{output}$$

This can be expanded and approximated by;

$$P_{loss} = (I_{rms}^2 \times R_{ds(on)}) + \left(I \times \frac{Q_{gd}}{i_g} \times V_{in} \times f \right) + \left(I \times \frac{Q_{gs2}}{i_g} \times V_{in} \times f \right) + (Q_g \times V_g \times f) + \left(\frac{Q_{oss}}{2} \times V_{in} \times f \right)$$

This simplified loss equation includes the terms Q_{gs2} and Q_{oss} which are new to Power MOSFET data sheets.

Q_{gs2} is a sub element of traditional gate-source charge that is included in all MOSFET data sheets. The importance of splitting this gate-source charge into two sub elements, Q_{gs1} and Q_{gs2} , can be seen from Fig 16.

Q_{gs2} indicates the charge that must be supplied by the gate driver between the time that the threshold voltage has been reached and the time the drain current rises to I_{dmax} at which time the drain voltage begins to change. Minimizing Q_{gs2} is a critical factor in reducing switching losses in Q1.

Q_{oss} is the charge that must be supplied to the output capacitance of the MOSFET during every switching cycle. Figure A shows how Q_{oss} is formed by the parallel combination of the voltage dependant (non-linear) capacitance's C_{ds} and C_{dg} when multiplied by the power supply input buss voltage.

Synchronous FET

The power loss equation for Q2 is approximated by;

$$P_{loss} = P_{conduction} + P_{drive} + P_{output}^*$$

$$P_{loss} = (I_{rms}^2 \times R_{ds(on)}) + (Q_g \times V_g \times f) + \left(\frac{Q_{oss}}{2} \times V_{in} \times f \right) + (Q_{rr} \times V_{in} \times f)$$

*dissipated primarily in Q1.

For the synchronous MOSFET Q2, $R_{ds(on)}$ is an important characteristic; however, once again the importance of gate charge must not be overlooked since it impacts three critical areas. Under light load the MOSFET must still be turned on and off by the control IC so the gate drive losses become much more significant. Secondly, the output charge Q_{oss} and reverse recovery charge Q_{rr} both generate losses that are transferred to Q1 and increase the dissipation in that device. Thirdly, gate charge will impact the MOSFETs' susceptibility to Cdv/dt turn on.

The drain of Q2 is connected to the switching node of the converter and therefore sees transitions between ground and V_{in} . As Q1 turns on and off there is a rate of change of drain voltage dV/dt which is capacitively coupled to the gate of Q2 and can induce a voltage spike on the gate that is sufficient to turn the MOSFET on, resulting in shoot-through current. The ratio of Q_{gd}/Q_{gs1} must be minimized to reduce the potential for Cdv/dt turn on.

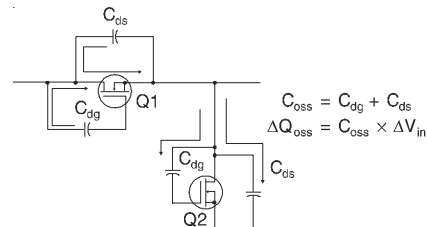
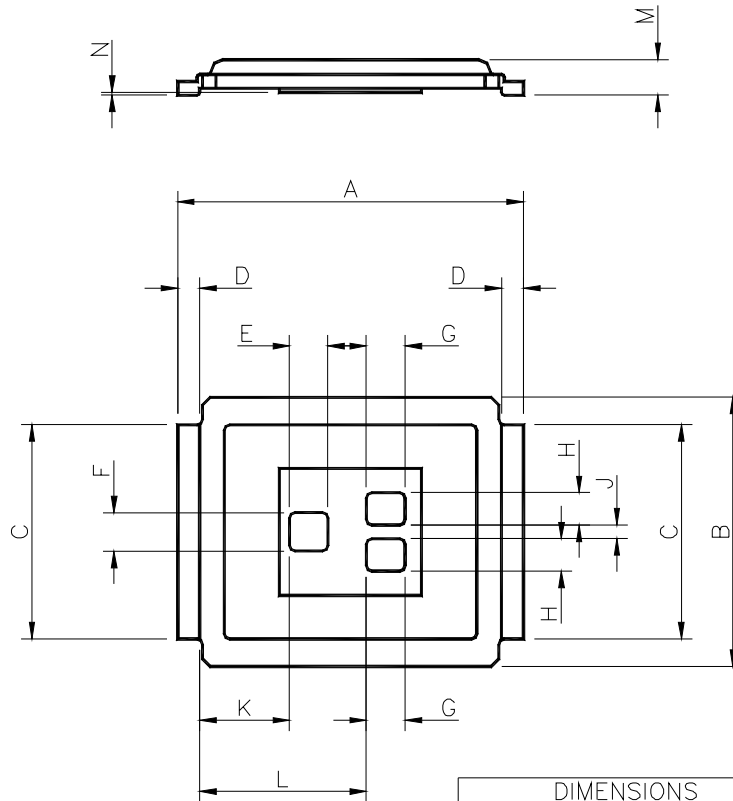

Figure A: Q_{oss} Characteristic

DirectFET™ Outline Dimension, MQ Outline
 (Medium Size Can, Q-Designation).



NOTE: Controlling dimensions
 are in mm

CODE	METRIC		IMPERIAL	
	MIN	MAX	MIN	MAX
A	6.25	6.35	0.246	0.250
B	4.80	5.05	0.189	0.201
C	3.85	3.95	0.152	0.156
D	0.35	0.45	0.014	0.018
E	0.68	0.72	0.027	0.028
F	0.68	0.72	0.027	0.028
G	0.69	0.73	0.027	0.029
H	0.57	0.61	0.022	0.024
J	0.23	0.27	0.009	0.011
K	1.57	1.70	0.062	0.067
L	2.95	3.12	0.116	0.123
M	0.59	0.70	0.023	0.028
N	0.03	0.08	0.001	0.003

IRF6604

International
IR Rectifier

DirectFET™ Board Footprint, MQ Outline
(Medium Size Can, Q-Designation).

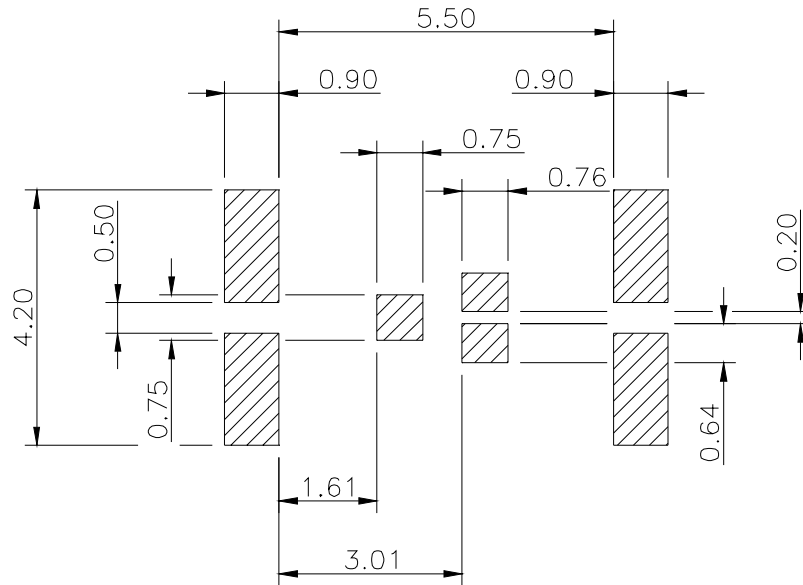

DirectFET™ Tape & Reel Dimension
(Showing component orientation).

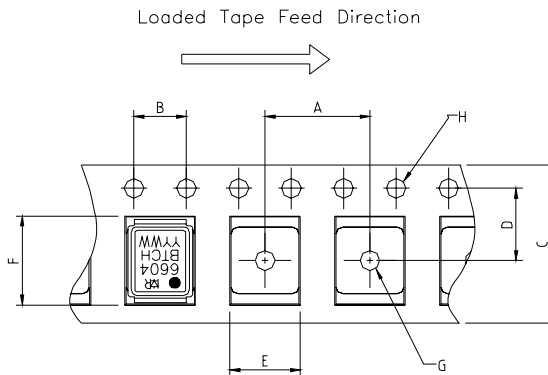
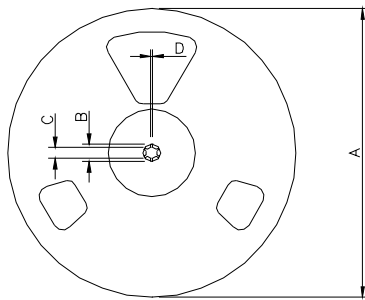
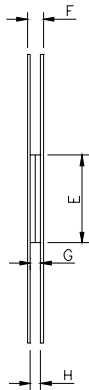

NOTE: Controlling dimensions in mm
Std reel quantity is 4800 parts.
(ordered as IRF6604).
For 1000 parts on 7" reel, order IRF6604TR1

CODE	METRIC		IMPERIAL	
	MIN	MAX	MIN	MAX
A	330.0	N.C	12.992	N.C
B	20.2	N.C	0.795	N.C
C	12.8	13.2	0.504	0.520
D	1.5	N.C	0.059	N.C
E	100.0	N.C	3.937	N.C
F	N.C	18.4	N.C	0.724
G	12.4	14.4	0.488	0.567
H	11.9	15.4	0.469	0.606

NOTE: CONTROLLING DIMENSIONS IN MM

CODE	METRIC		IMPERIAL	
	MIN	MAX	MIN	MAX
A	7.90	8.10	0.311	0.319
B	3.90	4.10	0.154	0.161
C	11.90	12.30	0.469	0.484
D	5.45	5.55	0.215	0.219
E	5.10	5.30	0.201	0.209
F	6.50	6.70	0.256	0.264
G	1.50	N.C	0.059	N.C
H	1.50	1.60	0.059	0.063

DirectFET™ Part Marking

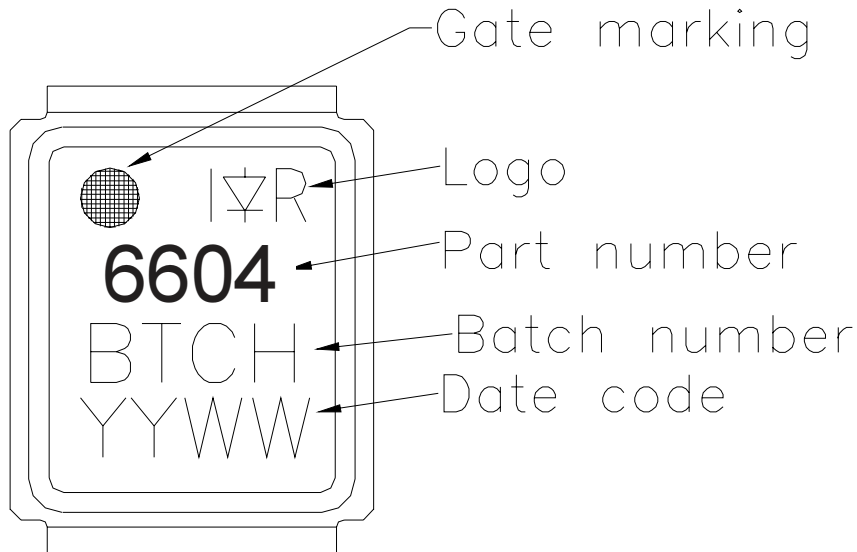

Notes:

- ① Repetitive rating; pulse width limited by max. junction temperature.
- ② Starting $T_J = 25^\circ\text{C}$, $L = 0.70\text{mH}$
 $R_G = 25\Omega$, $I_{AS} = 9.6\text{A}$.
- ③ Pulse width $\leq 400\mu\text{s}$; duty cycle $\leq 2\%$.
- ④ Surface mounted on 1 in. square Cu board.
- ⑤ Used double sided cooling, mounting pad.
- ⑥ Mounted on minimum footprint full size board with metalized back and with small clip heatsink.
- ⑦ T_C measured with thermal couple mounted to top (Drain) of part.

Data and specifications subject to change without notice.
This product has been designed and qualified for the Consumer market.
Qualification Standards can be found on IR's Web site.

International
IR Rectifier

IR WORLD HEADQUARTERS: 233 Kansas St., El Segundo, California 90245, USA Tel: (310) 252-7105
TAC Fax: (310) 252-7903

Visit us at www.irf.com for sales contact information.6/03