

Main Product Characteristics

BV_{DSS}	100V
$R_{DS(ON)}$	38m Ω
I_D	16A

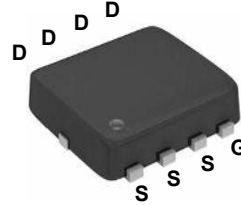

PPAK 3x3

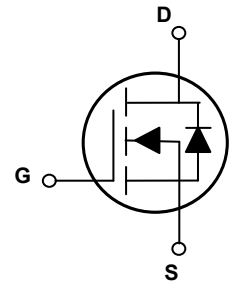

Schematic Diagram

Features and Benefits

- Advanced MOSFET process technology
- Ideal for high efficiency switched mode power supplies
- Low on-resistance with low gate charge
- Fast switching and reverse body recovery



Description

The GSFN0988 utilizes the latest techniques to achieve high cell density and low on-resistance. These features make this device extremely efficient and reliable for use in high efficiency switch mode power supplies and a wide variety of other applications.

Absolute Maximum Ratings ($T_C=25^\circ\text{C}$ unless otherwise specified)

Parameter	Symbol	Max.	Unit
Drain-Source Voltage	V_{DS}	100	V
Gate-Source Voltage	V_{GS}	+20/-12	V
Drain Current-Continuous ($T_C=25^\circ\text{C}$)	I_D	16	A
Drain Current-Continuous ($T_C=100^\circ\text{C}$)		10	
Drain Current-Pulsed ¹	I_{DM}	64	A
Single Pulse Avalanche Energy ²	E_{AS}	34	mJ
Single Pulse Avalanche Current ²	I_{AS}	26	A
Power Dissipation ($T_C=25^\circ\text{C}$)	P_D	32.5	W
Power Dissipation - Derate above 25 $^\circ\text{C}$		0.26	
Thermal Resistance, Junction-to-Ambient	$R_{\theta JA}$	62	$^\circ\text{C}/\text{W}$
Thermal Resistance, Junction-to-Case	$R_{\theta JC}$	3.85	$^\circ\text{C}/\text{W}$
Operating Junction Temperature Range	T_J	-55 To +150	$^\circ\text{C}$
Storage Temperature Range	T_{STG}	-55 To +150	$^\circ\text{C}$

Electrical Characteristics ($T_J=25^{\circ}\text{C}$ unless otherwise specified)

Parameter	Symbol	Conditions	Min.	Typ.	Max.	Unit
On / Off Characteristics						
Drain-Source Breakdown Voltage	BV_{DSS}	$V_{GS}=0V, I_D=250\mu A$	100	-	-	V
Drain-Source Leakage Current	I_{DSS}	$V_{DS}=100V, V_{GS}=0V, T_J=25^{\circ}\text{C}$	-	-	1	μA
		$V_{DS}=80V, V_{GS}=0V, T_J=125^{\circ}\text{C}$	-	-	10	μA
Gate-Source Leakage Current	I_{GSS}	$V_{GS}=20V, V_{DS}=0V$	-	-	100	nA
Static Drain-Source On-Resistance ³	$R_{DS(ON)}$	$V_{GS}=10V, I_D=10A$	-	32	38	m Ω
		$V_{GS}=4.5V, I_D=8A$	-	49	63	
Gate Threshold Voltage	$V_{GS(th)}$	$V_{GS}=V_{DS}, I_D=250\mu A$	1.0	1.6	2.5	V
Forward Transconductance	g_{fs}	$V_{DS}=10V, I_S=3A$	-	5	-	S
Dynamic and Switching Characteristics						
Total Gate Charge ^{3,4}	Q_g	$V_{DS}=50V, I_D=10A, V_{GS}=10V$	-	8	12	nC
Gate-Source Charge ^{3,4}	Q_{gs}		-	2.1	3.5	
Gate-Drain Charge ^{3,4}	Q_{gd}		-	2.3	4	
Turn-On Delay Time ^{3,4}	$t_{d(on)}$	$V_{DD}=50V, R_G=3.3\Omega, V_{GS}=10V, I_D=1A$	-	7.4	15	nS
Rise Time ^{3,4}	t_r		-	12	24	
Turn-Off Delay Time ^{3,4}	$t_{d(off)}$		-	23	46	
Fall Time ^{3,4}	t_f		-	16	32	
Input Capacitance	C_{iss}	$V_{DS}=20V, V_{GS}=0V, F=1\text{MHz}$	-	553	740	pF
Output Capacitance	C_{oss}		-	181	460	
Reverse Transfer Capacitance	C_{rss}		-	30	20	
Gate Resistance	R_g	$V_{GS}=0V, V_{DS}=0V, F=1\text{MHz}$	-	0.8	-	Ω
Drain-Source Diode Characteristics and Maximum Ratings						
Continuous Source Current	I_S	$V_G=V_D=0V, \text{Force Current}$	-	-	16	A
Pulsed Source Current	I_{SM}		-	-	32	A
Diode Forward Voltage	V_{SD}	$V_{GS}=0V, I_S=1A, T_J=25^{\circ}\text{C}$	-	-	1	V
Reverse Recovery Time	t_{rr}	$V_{GS}=0V, I_S=10A, di/dt=100A/\mu s, T_J=25^{\circ}\text{C}$	-	30	-	nS
Reverse Recovery Charge	Q_{rr}		-	24	-	nC

Note:

1. Repetitive rating: Pulsed width limited by maximum junction temperature.
2. $V_{DD}=50V, V_{GS}=10V, L=0.1\text{mH}, I_{AS}=26A, R_G=25\Omega$, starting $T_J=25^{\circ}\text{C}$.
3. Pulse test: pulse width $\leq 300\mu s$, duty cycle $\leq 2\%$.
4. Essentially independent of operating temperature.

Typical Electrical and Thermal Characteristic Curves

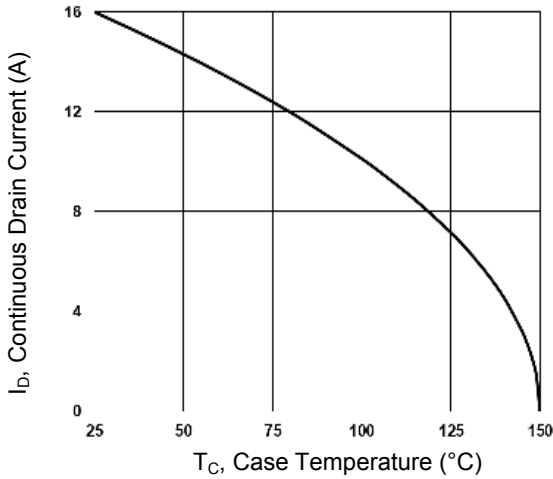

Figure 1. Continuous Drain Current vs. T_C

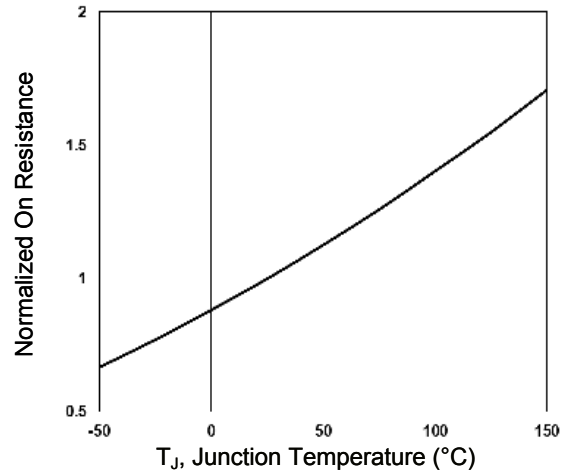

Figure 2. Normalized $R_{DS(on)}$ vs. T_J

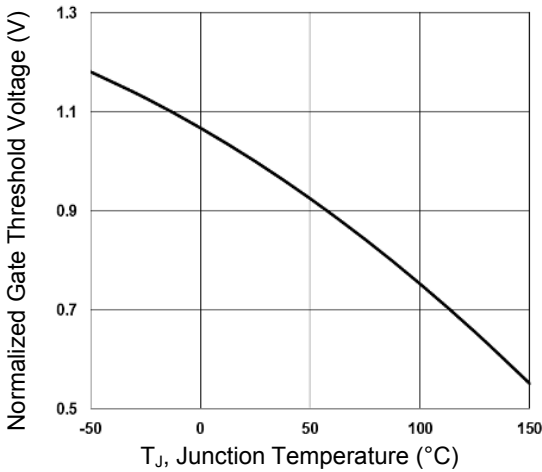

Figure 3. Normalized V_{th} vs. T_J

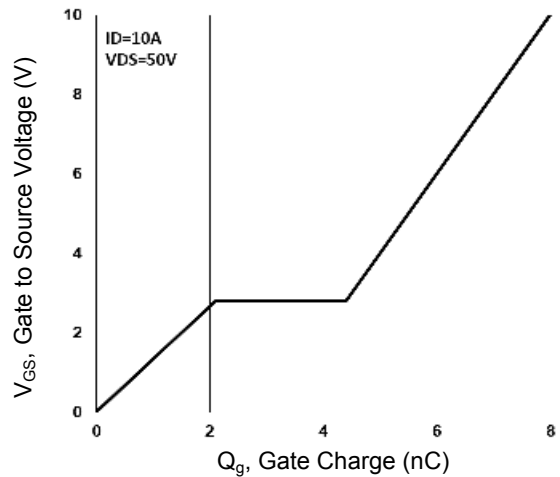

Figure 4. Gate Charge Characteristics

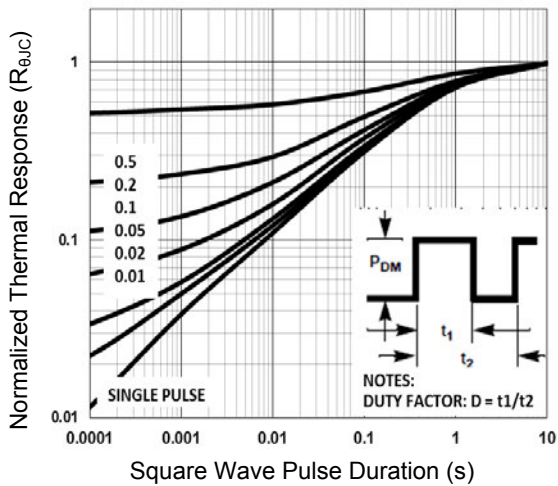

Figure 5. Normalized Transient Response

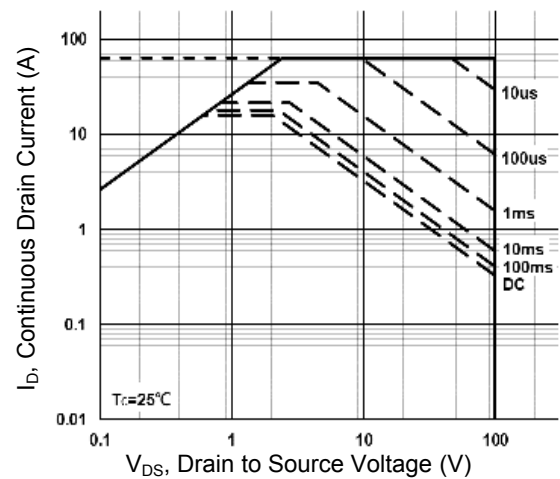

Figure 6. Maximum Safe Operation Area

Typical Electrical and Thermal Characteristic Curves

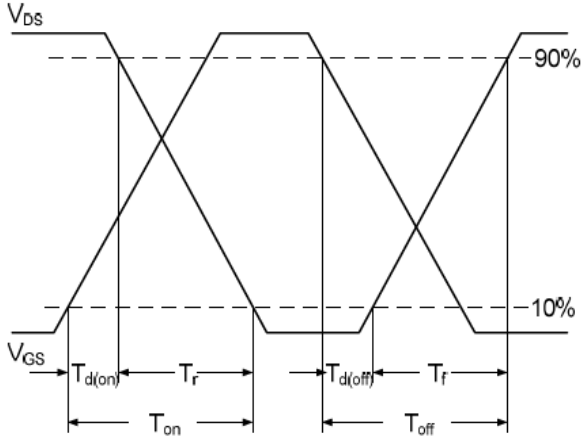

Figure 7. Switching Time Waveform

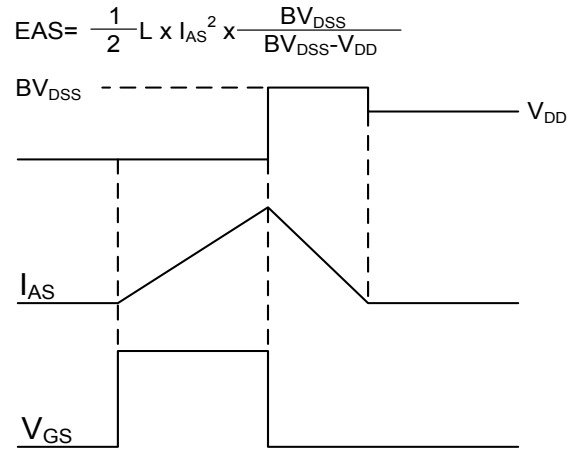
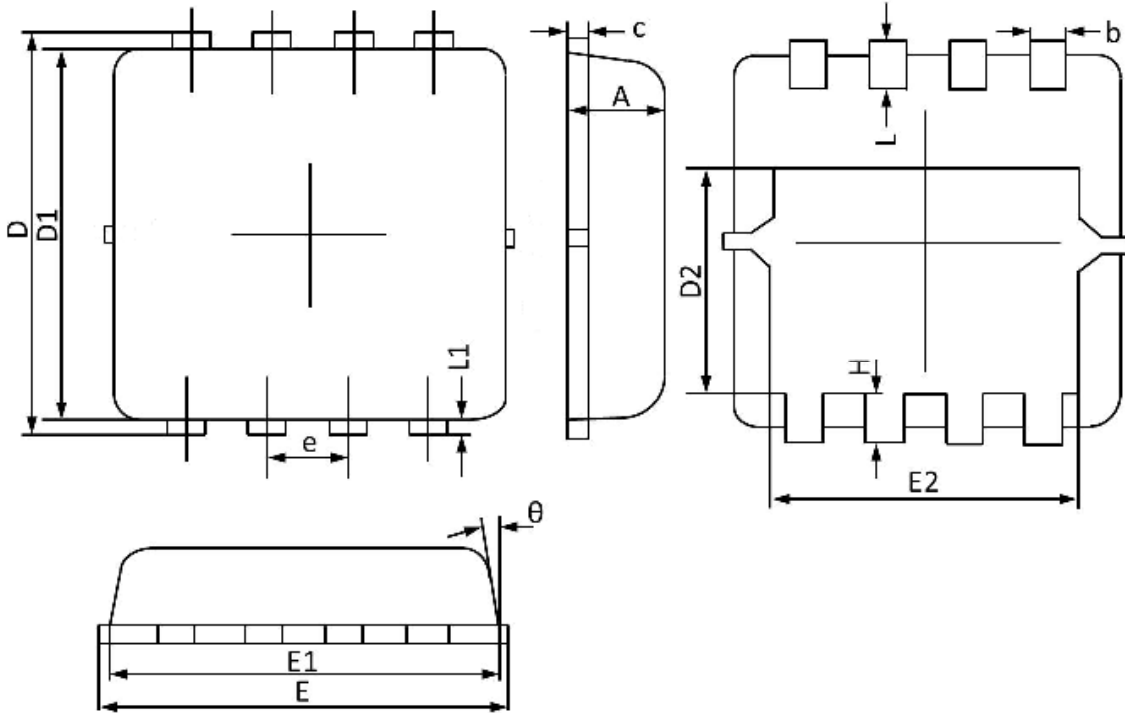

Figure 8. EAS Waveform

Package Outline Dimensions PPAK3x3



Symbol	Dimensions In Millimeters		Dimensions in Inches	
	MIN	MAX	MIN	MAX
A	0.700	0.900	0.028	0.035
b	0.240	0.350	0.009	0.014
c	0.100	0.250	0.004	0.010
D	3.050	3.450	0.120	0.136
D1	2.900	3.200	0.114	0.126
D2	1.350	1.850	0.053	0.073
E	3.000	3.400	0.118	0.134
E1	2.900	3.250	0.114	0.128
E2	2.350	2.600	0.093	0.102
e	0.650 BSC		0.026 BSC	
H	0.300	0.500	0.012	0.020
L	0.300	0.500	0.012	0.020
L1	0.070	0.200	0.003	0.008
θ	0°	12°	0°	12°

Order Information

Device	Package	Marking	Carrier	Reel QTY
GSFN0988	PPAK3x3	DC0988	Tape & Reel	3,000pcs