





# SPECIFICATIONS

**CUSTOMER** : \_\_\_\_\_  
**MODEL NO.** : **GFG096060A-FPNE-02**  
**VERSION** : **B**  
**DATE** : **2022.12.20**  
**CERTIFICATION** : **ROHS**

Customer Sign	Approved By	Prepared By	Prepared By
			

晶發科技股份有限公司  
GI FAR TECHNOLOGY CO.,LTD.

新北市樹林區東豐街 81 號

No. 81, Dongfeng St, Shulin District, 238034, New Taipei City, Taiwan, R.O.C.

TEL: +886-2-8684-1188 FAX: +886-2-8684-8532





## CONTENTS

1. Scope	-----	4
2. Product Specifications	-----	4
2.1 General	-----	4
2.2 Mechanical Characteristics	-----	4
2.3 Absolute Maximum Ratings	-----	4
2.4 Electrical Characteristics	-----	5
2.5 Optical Characteristics Absolute maximum ratings	-----	5
2.6 Optical Characteristics	-----	6
3. Reliability	-----	7
4. Operating Instructions	-----	8
4.1 Input signal Function	-----	8
4.2 Voltage Generator Circuit	-----	9
4.3 Timing Diagram	-----	10
5. Notes	-----	11
6. Operation Precautions	-----	11
7. LCM Dimensions	-----	12
8. Package information	-----	13
Appendix : Inspection Standard		



## 1. SCOPE

This specification covers the engineering requirements for the GFG096060A-FPNE-02 liquid crystal module.

## 2. PRODUCT SPECIFICATIONS

### 2.1 General

- 96 × 60 dot matrix LCD
- FSTN , Positive mode LCD panel
- Transflective , Wide temperature type
- 6 o'clock
- Multiplexing driving : 1/65 duty, 1/9 bias
- COG ST7558
- NO Backlight

### 2.2 Mechanical Characteristics

Item	Characteristic
Dot configuration	96 × 60
Dot dimensions(mm)	0.295 × 0.375
Dot spacing (mm)	0.32 × 0.4
Module dimensions (Horizontal × Vertical × Thickness, mm)	38.4 × 37.5 × 1.75 max.
Viewing area (Horizontal × Vertical, mm)	35.4 × 28.5
Active area (Horizontal × Vertical, mm)	30.695 × 23.975

### 2.3 Absolute Maximum Ratings (Without LED back-light)

Parameter	Symbol	Conditions	Unit
Power Supply Voltage	VDD	-0.5 ~ +5.0	V
Power supply voltage	V0	3.0 ~ 12	V
Power supply voltage	VLCDIN	-0.3 ~ +13.5	V
Power supply voltage	V1, V2, V3, V4	0.3 to VLCDIN	V
Input voltage	VIN	-0.5 to VDD+0.5	V
Output voltage	VO	-0.5 to VDD+0.5	V



## 2.4 Electrical Characteristics (Without LED back-light)

$V_{DD} = 1.8\text{ V to }3.3\text{ V}$ ;  $V_{SS} = 0\text{ V}$ ;  $V_{LCD} = 3.0\text{ to }13.0\text{ V}$ ;  $T_{amb} = -30^{\circ}\text{C to }+85^{\circ}\text{C}$ ; unless otherwise specified.

Item	Symbol	Condition	Rating			Units	Applicable Pin	
			Min.	Typ.	Max.			
Operating Voltage (1)	VDD		1.8	—	3.3	V	V <sub>SS</sub> *1	
Operating Voltage (2)	VDD2	(Relative to VSS)	1.8	—	3.3	V	VSS2	
High-level Input Voltage	VIHC		0.7 x VDD	—	VDD	V	*2	
Low-level Input Voltage	VILC		VSS	—	0.3 x VDD	V	*2	
High-level Output Voltage	VOHC		0.7 x VDD	—	VDD	V	*3	
Low-level Output Voltage	VOLC		VSS	—	0.3 x VDD	V	*3	
Input leakage current	ILI	VIN = VDD or VSS	-1.0	—	1.0	μA	*4	
Output leakage current	ILO	VIN = VDD or VSS	-3.0	—	3.0	μA	*5	
Liquid Crystal Driver ON Resistance	RON	Ta = 25°C (Relative To VSS)	VLCDIN = 13.0 V	—	2.0	3.5	KΩ	SEgN COMn *6
			VLCDIN = 8.0 V	—	3.2	5.4		
Oscillator Frequency	Internal Oscillator	fOSC	—	80	84	kHz	*7	
	External Input	fCL	1/65 duty	80	84	kHz	OSC	
	Frame frequency	fFRAME		—	77	80.3	Hz	

Item	Symbol	Condition	Rating			Units	Applicable Pin	
			Min.	Typ.	Max.			
Internal Power	Input voltage	VDD	(Relative To VSS)	1.8	—	3.3	V	
	Supply Step-up output voltage Circuit	VLCDOUT	(Relative To VSS)	—	—	13.5	V	VLCDOUT
	Voltage regulator Circuit Operating Voltage	VLCDIN	(Relative To VSS)	—	—	13.5	V	VLCDIN

## 2.5 Optical Characteristics Absolute maximum ratings

Item	Symbol	Rating	Unit
Operating temperature range	Top	-20~70	°C
Storage temperature range	Tst	-30~80	°C



## 2.6. Optical Characteristics

1/65 duty, 1/9 bias,  $V_{op}=8.2$  V,  $T_a=25^\circ\text{C}$

Item	Symbol	Conditions	Min.	Typ.	Max	Reference
Driving voltage	$V_{op}$		--	8.2	--	
Viewing angle	$\theta_1$ 、 $\theta_2$	$C \geq 2.0, \phi = 0^\circ$ C	$30^\circ$	-	-	Notes 1 & 2
Contrast	C	$\theta = 5^\circ, \phi = 0^\circ$	2.0	-	-	Note 3
Response time(rise)	$t_{on}$	$\theta = 5^\circ, \phi = 0^\circ$	-	135ms	-	Note 4
Response time(fall)	$t_{off}$	$\theta = 5^\circ, \phi = 0^\circ$	-	200ms	-	Note 4

Note 1: Definition of angles  $\theta$  and  $\phi$

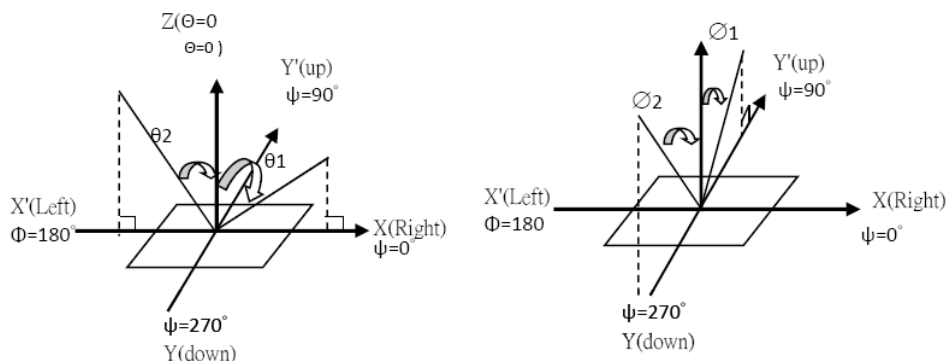

Note 2: Definition of viewing angles  $\theta_1$  and  $\theta_2$

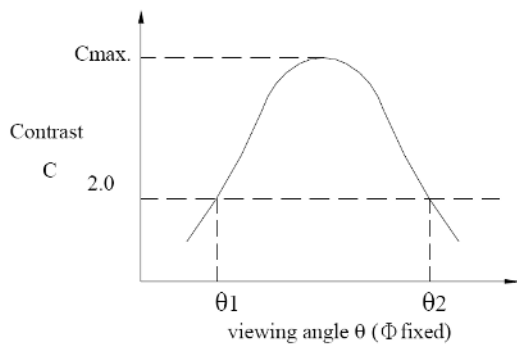

Note : Optimum viewing angle with the naked eye and viewing angle  $\theta$  at  $C_{max}$ . Above are not always the same

Note 3: Definition of contrast C

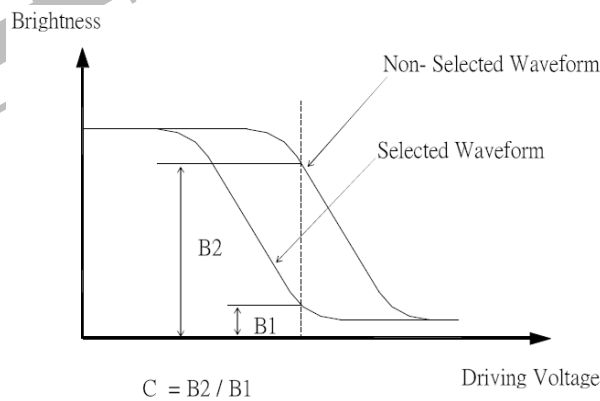

Note 4: Definition of response time

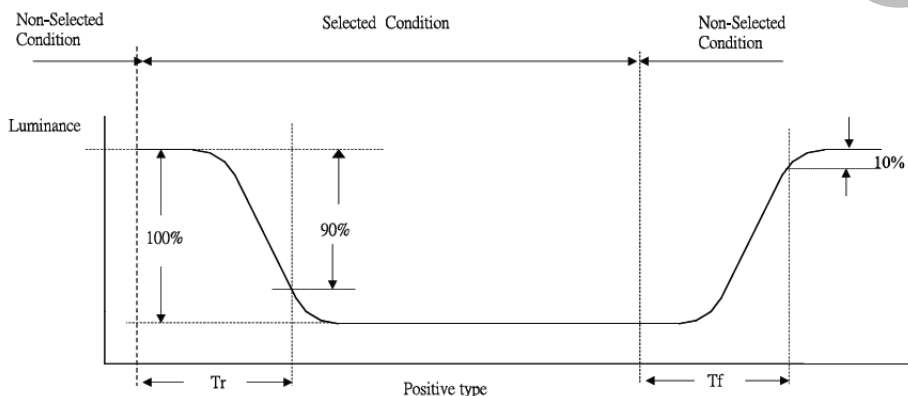



### 3. RELIABILITY

NO.	ITEM	CONDITION		STANDARD	NOTE
1	High Temp. Storage	80°C	120 hrs	Appearance Without defect	
2	Low Temp. Storage	-30°C	120 hrs	Appearance Without defect	
3	High Temp. & High Humi. Storage	40°C 90% RH	120 hrs	Appearance Without defect	
4	High Temp. Operating Display	70°C	120 hrs	Appearance Without defect	
5	Low Temp. Operating Display	-20°C	120 hrs	Appearance Without defect	
6	Thermal Shock	-20°C, 30min. → 70°C, 30min. ↑ (1cycle)		Appearance Without defect	10 cycles

\*\* Dissipation current, contrast and display functions

\*\* Polarizing filter deterioration, other appearance defects

\*\* The function test shall be conducted after 4hours storage at the normal temperature and humidity after remove from the test chamber.



## 4. OPERATING INSTRUCTIONS

### 4.1 Input signal Function

NO.	Symbol	Function
1	VDD	Power supply for logic
2	SCL	serial input clock
3	SI	serial input data
4	A0	It determines whether the data bits are data or a command. A0=" H ": Indicates that D0 to D7 are display data. A0=" L ": Indicates that D0 to D7 are control data.
5	/CS	Chip select input pins Data/instruction I/O is enabled only when CSB is " L ". When chip select is non-active, DB0 to DB7 is high impedance. When CSB pin in two line interface, this pin should fix to " H "
6	VSS	Ground
7	VOUT	If the internal voltage generator is used, the VLCDIN & VLCDOUT must be connected together and series one capacitor to VSS2. If an external supply is used this pin must be left open.
8~16	RESETB	Reset input pin When RESET is " L ", initialization is executed.





## 4.2 Voltage Generator Circuit

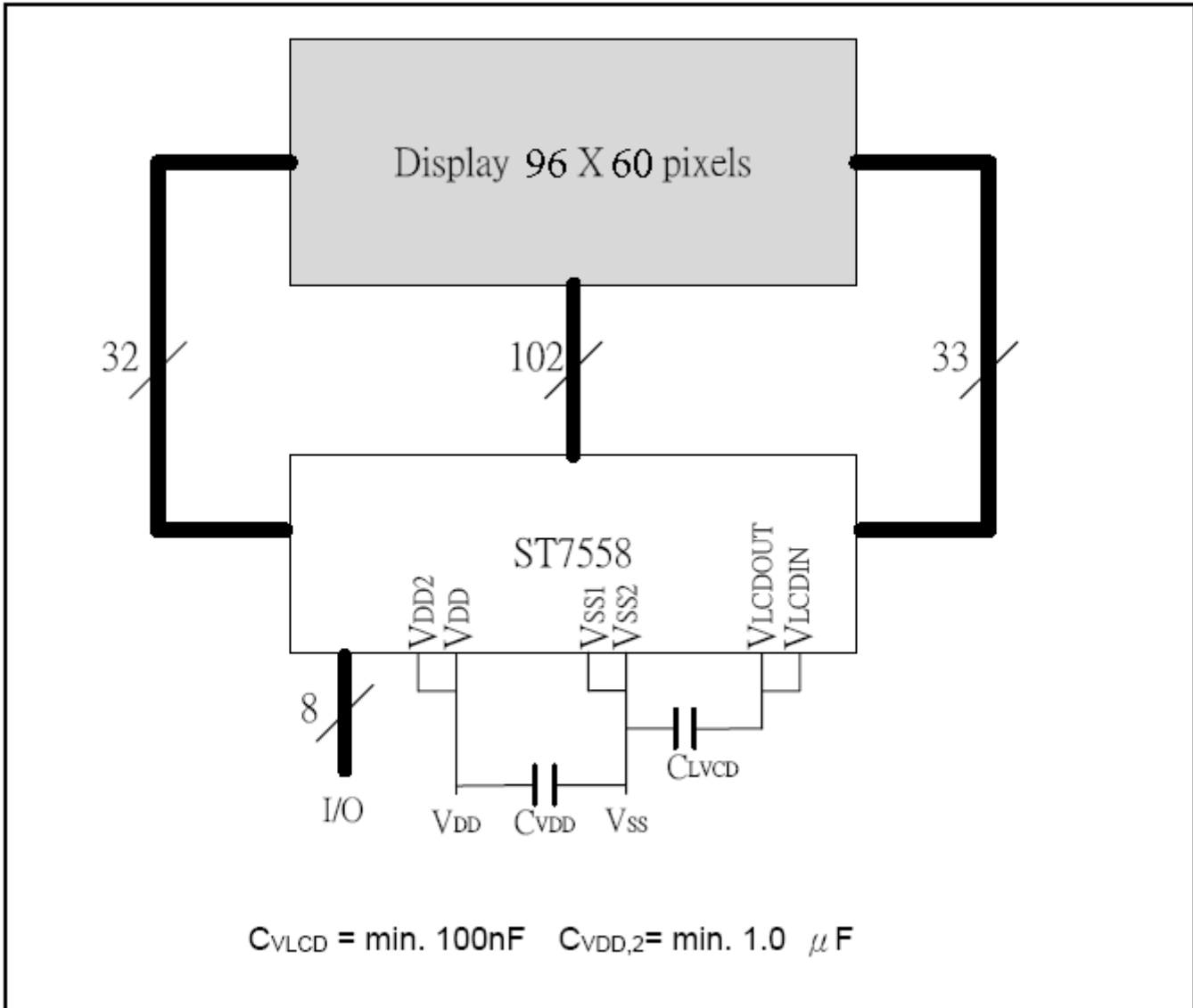

Serial Interface (4-line interface)

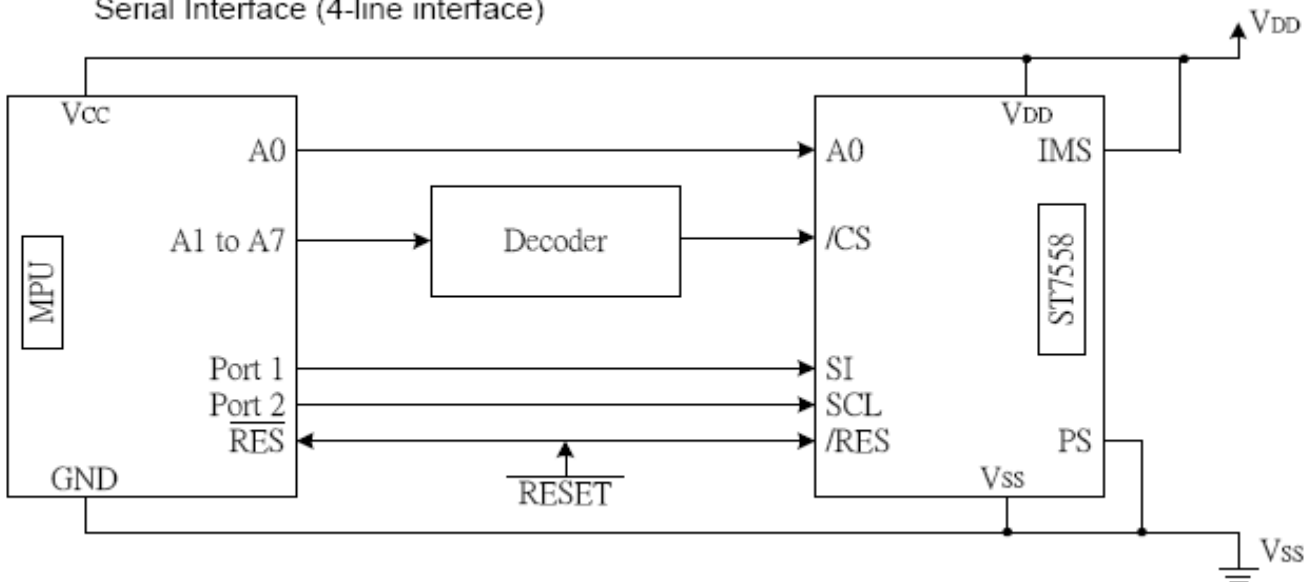



### 4.3 Timing Diagram

SERIAL INTERFACE(4-Line Interface)

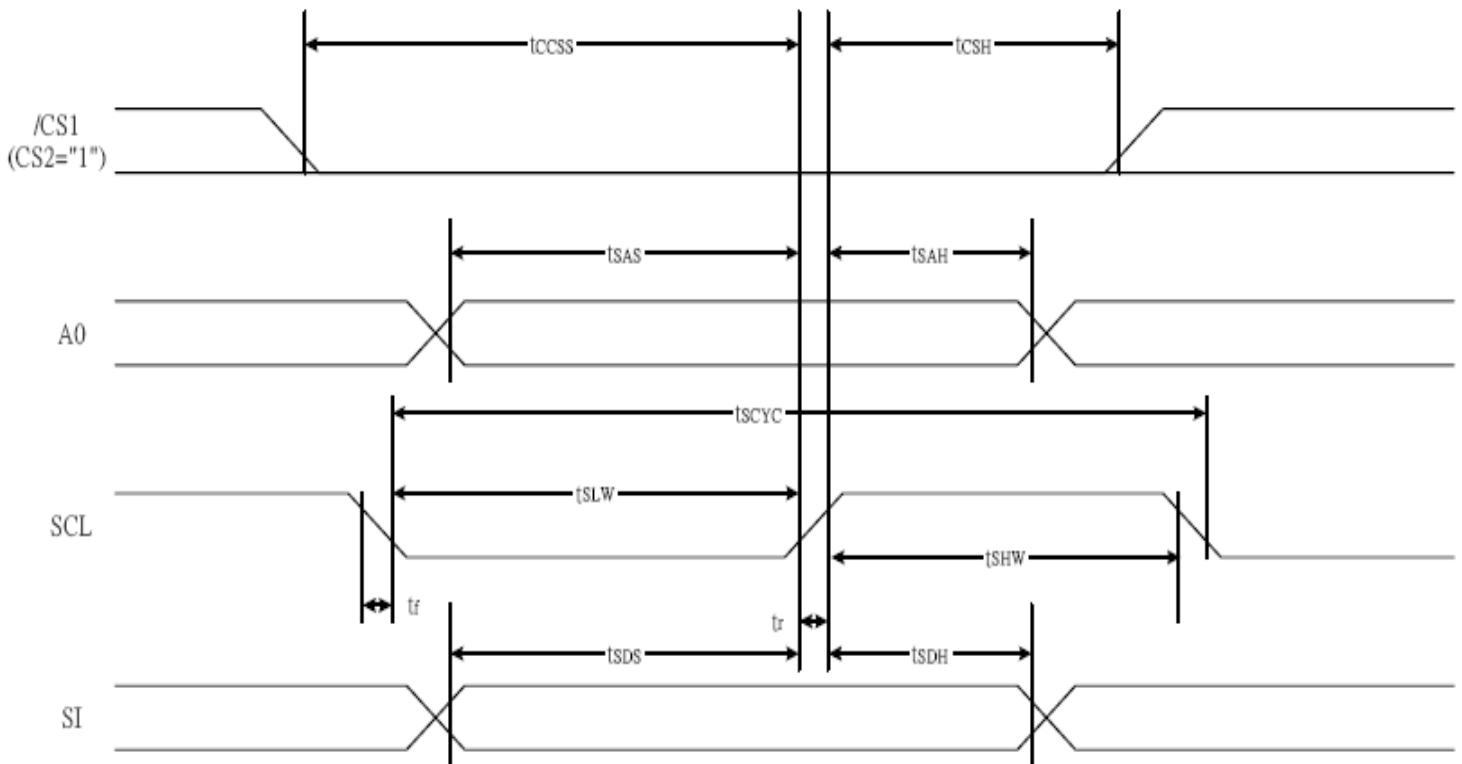

( $V_{DD}=3.3V, T_a=-30\sim 85^{\circ}C$ )

Item	Signal	Symbol	Condition	Rating		Units
				Min.	Max.	
Serial Clock Period	SCL	tSCYC		50	—	ns
SCL "H" pulse width		tSHW		25	—	
SCL "L" pulse width		tSLW		25	—	
Address setup time	A0	tSAS		20	—	
Address hold time		tSAH		10	—	
Data setup time	SI	tSDS		20	—	
Data hold time		tSDH		10	—	
CS-SCL time	CSB	tCSS		20	—	
CS-SCL time		tCSH		140	—	



## 5. NOTES

### ▪ Safety

- If the LCD panel breaks, be careful not to get the liquid crystal in your mouth. If the liquid crystal touches your skin or clothes, wash it off immediately using soap and plenty of water.

### Handling

- Avoid static electricity as this can damage the CMOS LSI.
- The LCD panel is plate glass; do not hit or crush it.
- Do not remove the panel or frame from the module.
- The polarizing plate of the display is very fragile; handle it very carefully

### Mounting and Design

- Mount the module by using the specified mounting part and holes.
- To protect the module from external pressure, leave a small gap by placing transparent plates (e.g. acrylic or glass ) on the display surface, frame, and polarizing plate
- Design the system so that no input signal is given unless the power-supply voltage is applied.
- Keep the module dry. Avoid condensation, otherwise the transparent electrodes may break.

### Storage

- Store the module in a dark place where the temperature is  $25\text{ }^{\circ}\text{C}\pm 10\text{ }^{\circ}\text{C}$  and the humidity below 65% RH.
- Do not store the module near organic solvents or corrosive gases.
- Do not crush, shake, or jolt the module (including accessories).

### Cleaning

- Do not wipe the polarizing plate with a dry cloth, as it may scratch the surface.
- Wipe the module gently with soft cloth soaked with a petroleum benzine.
- Do not use ketonic solvents (ketone and acetone) or aromatic solvents (toluene and xylene), as they may damage the polarizing plate.

## 6. OPERATION PRECAUTIONS

Any changes that need to be made in this specification or any problems arising from it will be dealt with quickly by discussion between both companies.

Quality warranty period: Within one year after shipment date (excluding abnormal usage way and abnormal environments.)



## 7. LCM Dimension

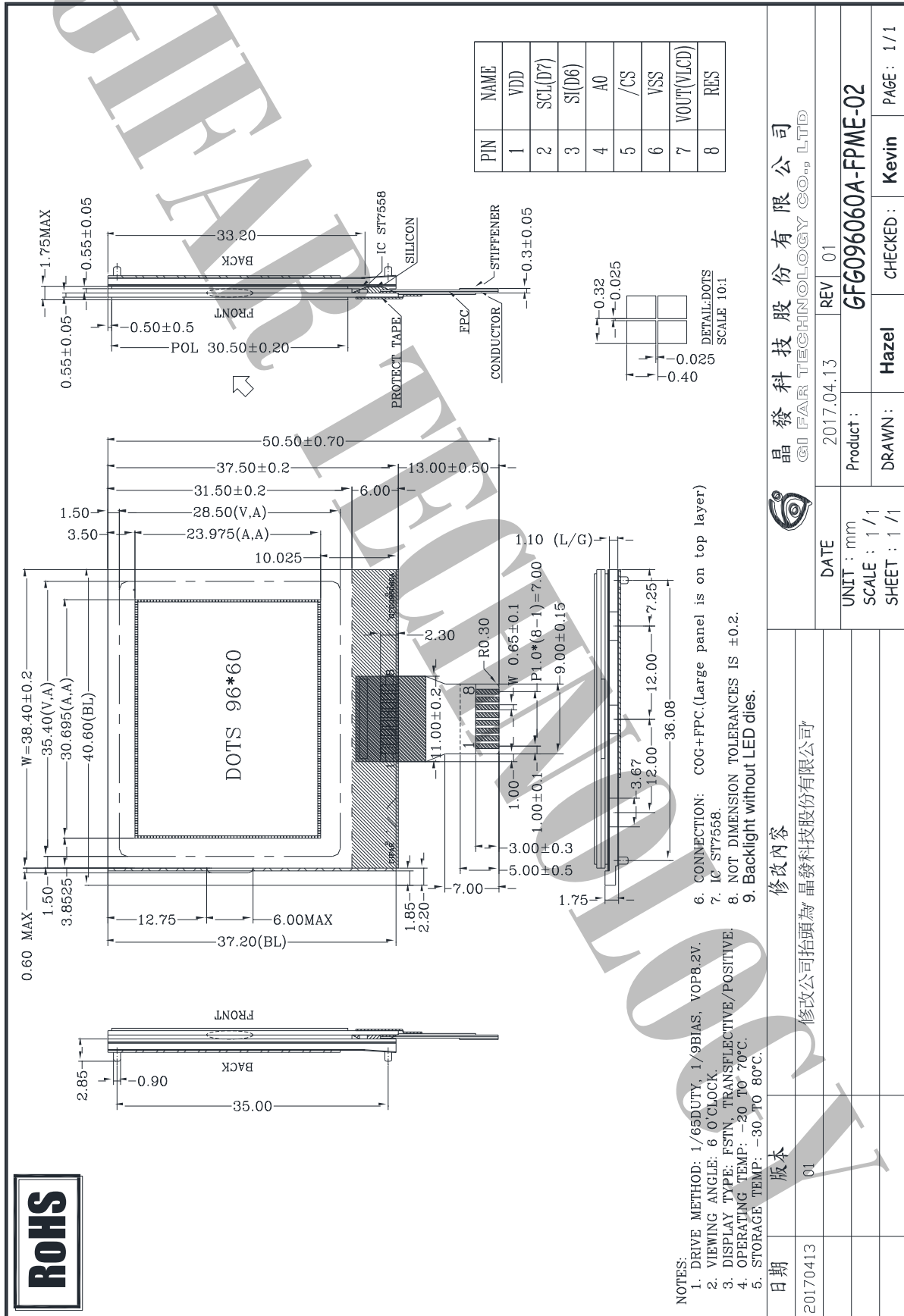

晶發科技股份有限公司  
GI FAR TECHNOLOGY CO., LTD.



修改內容

修改公司抬頭為 晶發科技股份有限公司

日期

20170413

DATE	2017.04.13	REV	01
UNIT : mm			
SCALE : 1 / 1			
SHEET : 1 / 1			
Product :	GFG096060A-FPME-02		
DRAWN :	Hazel	CHECKED :	Kevin
			PAGE : 1 / 1



## 8. PACKAGE INFORMATION

1	1 Tray	:	12 pcs (modules)
2	1 stack	:	20 tray +1 Cover tray
3	1 Carton	:	(1 Cover tray + 20 tray )x 3 stack+(1 Cover tray +10tray)
4	Total pcs	:	1 Carton = 840 pcs
5	Carton size = NO. 17	:	495*315*435mm
6	Net weight	:	TBD KG
7	Gross weight	:	TBD KG

\*\* Packaging information\*\*

- 1 Tray = 12 pcs



- 1 stack=20 tray+1 Cover tray



\*\*Each layer of tray should be staggered stacked

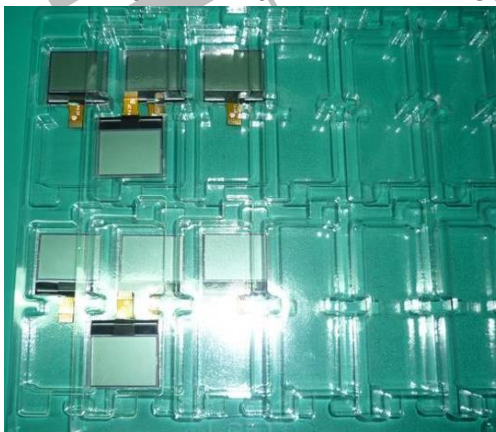

- 1 Carton = 3 stack+(1 Cover tray +10tray), Total pcs = 840 pcs

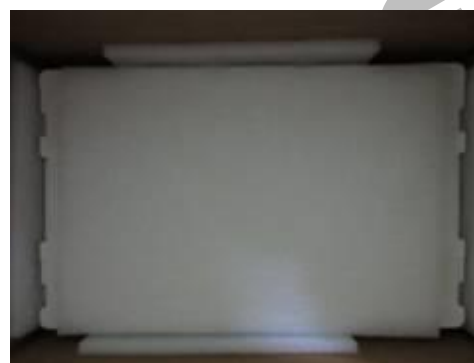

出貨檢驗標準書  
Shipping inspection standard

核准 Approved by	審核 Checked by	作成 Made by
ANDY	JACKY	RUBY

**1.目的 Purpose :**

規範出貨產品之檢驗項目及判斷標準，確保產品出貨能滿足客戶要求。

Standardize the inspection items and judgment standards to ensure the products that shipped out can meet customer's requirements.

**2.範圍 Area :**

適用於出廠之所有產品。

Applicable to all products shipped from the factory.

**3.名詞解釋 Explanation of terms :**

3-1 主要缺陷：亦會造成功能缺失或嚴重外觀缺陷。

Major Defects: It also causes loss of function or serious appearance defects.

3-2 次要缺陷：稍有缺陷但不影響客戶使用。

Minor defect: Slightly defective but does not affect customer use.

**4.檢驗體制 Inspection system :**

4-1 抽樣計劃：依 ANSI/ASQ Z1.4 一般檢驗水準 II 之 正常檢驗一次抽驗方案。

Sampling plan: According to ANSI/ASQ Z1.4 general inspection level II the normal inspection one-time sampling plan.

4-2 允收水準 Acceptable Level : (AQL)

主要缺陷 Major defect : 0.4 %

次要缺陷 Minor defect : 0.65 %

**5.檢驗條件 Inspection conditions :**

5-1 使用相關之檢測儀器及測試、量測工具。

Use relevant testing instrument, testing and measuring tools .

5-2 環境要求：其條件需控制在常溫下  $23^{\circ}\text{C}\pm 3^{\circ}\text{C}$  及溼度 70%RH 以下。

Environmental requirements: The conditions should be controlled at room temperature  $23^{\circ}\text{C}\pm 3^{\circ}\text{C}$  and humidity below 70%RH.

5-3 外觀檢驗：須在  $380\pm 20\%$  LUX 的白色日光燈下，其目視距離需於產品離  $30\pm 5$  cm 檢驗。

Appearance inspection: Under the white fluorescent lamp of  $380\pm 20\%$  LUX , the visual distance shall be checked above the product  $30 \pm 5$  cm.

5-4 電性測試 Electrical Testing :

5-4-1 有背光之產品需關燈並在  $5\sim 300\text{Lux}\pm 3\%$  下檢驗。

The products with backlight should be tested at  $5\sim 300\pm 3\%$  Lux.

5-4-2 無背光之產品需開燈並在  $60\sim 300\text{Lux}\pm 3\%$  白色日光燈下檢驗。

Products without backlight need to be turned on and tested under  $60\sim 300 \pm 3\%$  LUX white fluorescent lamps .

5-5 檢查視角依產品視角方向。

Check the viewing angle according to the product viewing angle.

5-6 其不良現象檢視區域 Bad phenomenon View area

5-6-1 適用種類 Applicable category : COB、TFT

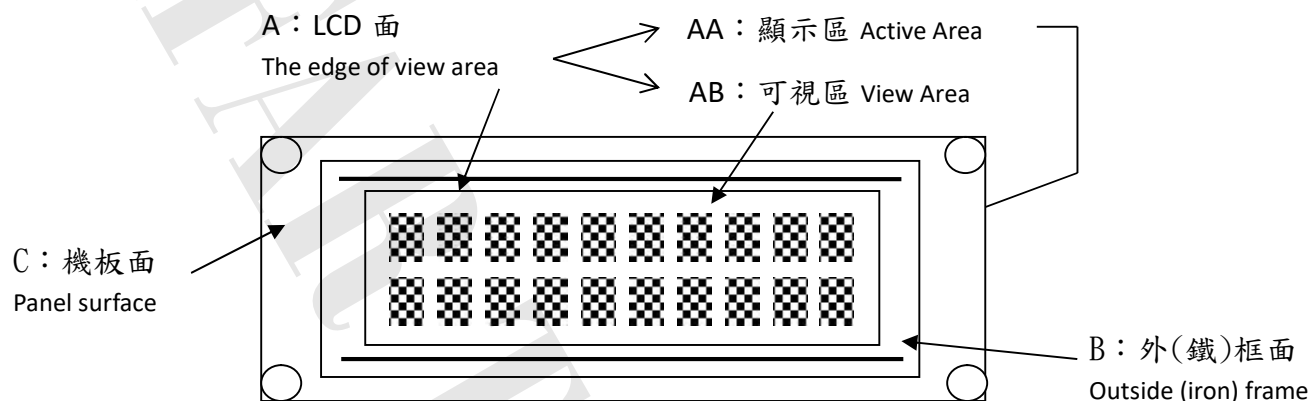

5-6-2 適用種類 Applicable category : COG、TAB、TN

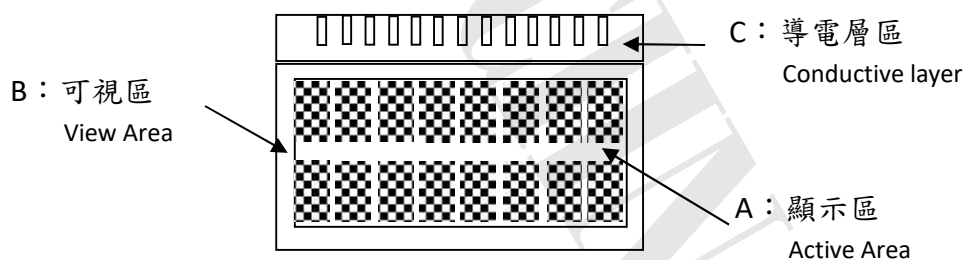



種類 Category		COG																			
編號 No.	檢驗項目 Item	檢驗內容及判定標準 Inspection Content & Standard			區域 Zone	類別 Category	缺陷等級 Level														
1	點類(一) Dot(1)	黑點、刺傷...等圓狀 Black dot、Stab...and other round shape $\phi = \frac{(X + Y)}{2}$ 	兩點距離須超過 5 mm Two points have to be $\geq 5$ mm		A B	外觀 Appearance	次要 Minor AQL0.65%														
		$\phi$ (mm)	允收數 Acceptance Qty																		
		$\phi \leq 0.1$	無視 Ignore																		
		$0.1 < \phi \leq 0.25$	3																		
		$0.25 < \phi \leq 0.3$	1																		
		$\phi > 0.3$	0																		
2	點類(二) Dot(2)	氣泡、凹凸點 Bubble、Uneven dots $\phi = \frac{(X + Y)}{2}$ 	兩點距離須超過 5 mm Two points have to be $\geq 5$ mm		A B	外觀 Appearance	次要 Minor AQL0.65%														
		$\phi$ (mm)	允收數 Acceptance Qty																		
		$\phi \leq 0.2$	無視 Ignore																		
		$0.2 < \phi \leq 0.5$	2																		
		$\phi > 0.5$	0																		
3	線類 Line	刮傷、毛屑...等線狀 Scratch、Fiber.. and other linear shape. 	<table border="1"> <thead> <tr> <th>L (mm)</th> <th>W (mm)</th> <th>允收數 Acceptance Qty</th> </tr> </thead> <tbody> <tr> <td>--</td> <td><math>W \leq 0.02</math></td> <td>無視 Ignore</td> </tr> <tr> <td><math>L \leq 5</math></td> <td><math>W \leq 0.03</math></td> <td>3</td> </tr> <tr> <td><math>L \leq 3</math></td> <td><math>W \leq 0.05</math></td> <td>2</td> </tr> <tr> <td><math>L &gt; 5</math></td> <td><math>W &gt; 0.05</math></td> <td>0</td> </tr> </tbody> </table>	L (mm)	W (mm)	允收數 Acceptance Qty	--	$W \leq 0.02$	無視 Ignore	$L \leq 5$	$W \leq 0.03$	3	$L \leq 3$	$W \leq 0.05$	2	$L > 5$	$W > 0.05$	0	A B	外觀 Appearance	次要 Minor AQL0.65%
L (mm)	W (mm)	允收數 Acceptance Qty																			
--	$W \leq 0.02$	無視 Ignore																			
$L \leq 5$	$W \leq 0.03$	3																			
$L \leq 3$	$W \leq 0.05$	2																			
$L > 5$	$W > 0.05$	0																			
4	底色 Background color	同批供貨不能有明顯色差 No obvious color difference allowed in same shipment. (必要時與客端制定限度樣) (According to the gold samples if necessary)			B	外觀 Appearance	次要 Minor AQL0.65%														
5	FPC 外觀 FPC Appearance	※ FPC 上刺傷導致線路無法導通 拒收 Stabbing on the FPC causes the line to fail to conduct Reject ※ FPC 上髒污或是殘留異物以致線路無法導通 拒收 Dirty or residual foreign matter on the FPC makes the circuit unable to conduct Reject ※ FPC 直角折痕、斷裂 拒收 FPC right-angle crease and fracture Reject			C	外觀 Appearance	主要 Major AQL 0.4%														

6	點、線類 (三) Dot、Line (3)	※ 於全黑、白畫面下看見之區塊狀或線狀不良 拒收 There is a block or linear in the view area under the screen is whole black or white. Reject ※ 但依 2% ND Filter 遮蓋無視 允收 But after inspecting by 2% ND Filter without seeing block or linear, it is confirmed Acceptance	A	電訊 Electronics	次要 Minor AQL0.65%
7	點、線類 (四) Dot、Line (4)	畫面中顯示出現黑、白、亮、異色點或線狀 There is a black, white, bright or other dot or lines showing in the view area. ※ 依編號 1、3 之判定標準 According to the inspection standard: No. 1 and 3.	A	電訊 Electronics	次要 Minor AQL0.65%
8	缺字 Lack of characters	顯示時畫面缺少部份字元 拒收 Lacking part of characters in the view area. Reject	A	電訊 Electronics	主要 Major AQL 0.4%
9	無動作 No reaction	顯示畫面一直處於起始畫面而無法進行切換 拒收 The display (view area) always show in the initial screen and can't be switched to others. Reject	A	電訊 Electronics	主要 Major AQL 0.4%
10	無畫面 No display	通電後，完全無任何畫面顯示 拒收 After connecting to the power, there is no image. Reject	A	電訊 Electronics	主要 Major AQL 0.4%
11	斷線 Broken line	顯示畫面中少直、橫線 拒收 There is a lack of vertical or horizontal lines in the view area. Reject	A	電訊 Electronics	主要 Major AQL 0.4%
12	CROSS TALK	顯示畫面時有局部之條紋或拖影 There are some stripes or shadow/smear showing in the view area. 拒收或與客端簽訂限度樣 Reject or inspect according to the golden sample	A	電訊 Electronics	次要 Minor AQL0.65%
13	I CON	顯示畫面缺少部份顯示圖案 拒收 Lack of partial ICON in the view area. Reject	A	電訊 Electronics	主要 Major AQL 0.4%

14	深淺不一 Color difference	顯示畫面的對比，比其他顯示深或淺並依電氣規格(VOP)值判定 The color contrast of display is obviously lighter or darker than others and according to the VOP value in the electronics specification. 拒收或與客端簽訂限度樣 Reject or inspect according to the golden sample	A	電訊 Electronics	次要 Minor AQL0.65%												
15	畫面異常 Abnormal screen	通電後畫面出現未定義之電訊不良現象 拒收 After connecting to the power, there is an undefined electronics appearance showing in the view area. Reject	A	電訊 Electronics	主要 Major AQL 0.4%												
16	背光色不均 Uneven color of backlight	※ 點亮後 LED 有明暗不均現象依其均勻度判定 拒收 After lighting LEDs have brightness and darkness uneven the determined according to its uniformity. Reject ※ 點亮後 LED 色澤不一致 拒收 LED color is inconsistent after lighting. Reject	A	電訊 Electronics	次要 Minor AQL0.65%												
17	亮度不足 Lack of brightness	波長、色座標、輝度與圖面標示定義不符 拒收 Wave length, chromatic coordinates, brightness don't correspond to the definition of the drawing. Reject	A	電訊 Electronics	主要 Major AQL 0.4%												
18	背光腳柱 Backlit foot post	斷裂、長度不一 拒收 Fracture, different length Reject	--	外觀 Appearance	次要 Minor AQL0.65%												
19	破損 Damaged	<p>Y：破損寬 X：破損長 Y: Damaged width X: Damaged length</p>  <table border="1" data-bbox="566 1635 1109 1982"> <thead> <tr> <th>Y</th> <th>X</th> <th>判定 Determination</th> </tr> </thead> <tbody> <tr> <td><math>Y \leq 1.0</math></td> <td>-- --</td> <td>允收 Acceptance</td> </tr> <tr> <td>未進入可視區 Did not enter the viewing area</td> <td><math>\leq 1/8</math> 玻璃該邊長 <math>\leq 1/8</math> The side length of the glass</td> <td>允收 Acceptance</td> </tr> <tr> <td>進入可視區 Enter the viewing area</td> <td>-- --</td> <td>拒收 Reject</td> </tr> </tbody> </table>	Y	X	判定 Determination	$Y \leq 1.0$	-- --	允收 Acceptance	未進入可視區 Did not enter the viewing area	$\leq 1/8$ 玻璃該邊長 $\leq 1/8$ The side length of the glass	允收 Acceptance	進入可視區 Enter the viewing area	-- --	拒收 Reject	B	外觀 Appearance	次要 Minor AQL0.65%
Y	X	判定 Determination															
$Y \leq 1.0$	-- --	允收 Acceptance															
未進入可視區 Did not enter the viewing area	$\leq 1/8$ 玻璃該邊長 $\leq 1/8$ The side length of the glass	允收 Acceptance															
進入可視區 Enter the viewing area	-- --	拒收 Reject															

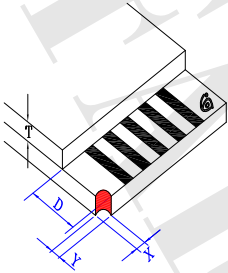
20	角崩 Corner collapse		Y：破損寬 X：破損長 Y: Damaged width X: Damaged length <table border="1" data-bbox="568 535 1102 844"> <thead> <tr> <th>Y</th> <th>X</th> <th>判定 Determination</th> </tr> </thead> <tbody> <tr> <td><math>\leq 1/3D</math></td> <td>-- --</td> <td>允收 Acceptance</td> </tr> <tr> <td><math>1/3D &lt; Y \leq D</math></td> <td><math>\leq 1/8</math> 玻璃邊長 <math>\leq 1/8</math> The side length of the glass</td> <td>允收 Acceptance</td> </tr> <tr> <td><math>&gt; D</math></td> <td>-- --</td> <td>拒收 Reject</td> </tr> </tbody> </table>	Y	X	判定 Determination	$\leq 1/3D$	-- --	允收 Acceptance	$1/3D < Y \leq D$	$\leq 1/8$ 玻璃邊長 $\leq 1/8$ The side length of the glass	允收 Acceptance	$> D$	-- --	拒收 Reject	C	外觀 Appearance	次要 Minor AQL0.65%
Y	X	判定 Determination																
$\leq 1/3D$	-- --	允收 Acceptance																
$1/3D < Y \leq D$	$\leq 1/8$ 玻璃邊長 $\leq 1/8$ The side length of the glass	允收 Acceptance																
$> D$	-- --	拒收 Reject																
21	尺寸量測 Size Measurement	未依圖面上標示 拒收 No correspond to the indication on the drawing. Reject	ALL	外觀 Appearance	主要 Major AQL 0.4%													
22	其他 Other	如發現有上述未定義之不良則與客端簽訂限度樣 If there is another undefined defective situation. It will be listed as others. The inspection standard is according to the golden sample.	ALL	電訊 Electronics 外觀 Appearance	次要 Minor AQL0.65%													