



High Density Card Edge

**1.00 mm [.039"] Contact Centers, PCI Express,
Card Extender for Straddle Mount**

SULLINS

High Density Card Edge

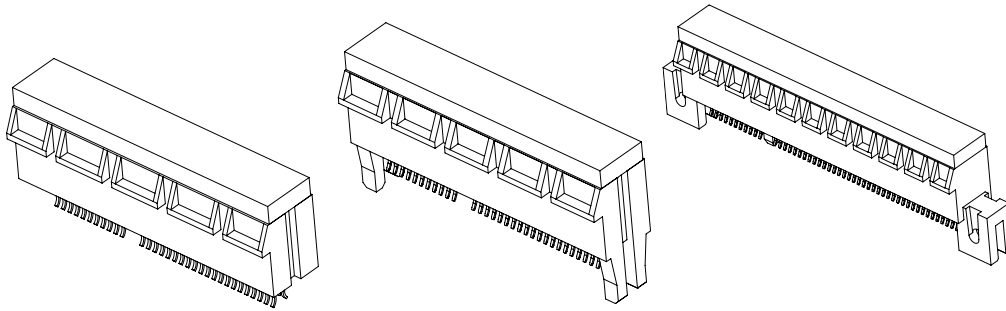

DIMENSIONS Dimensions in [] are in inches, all others are in millimeters.

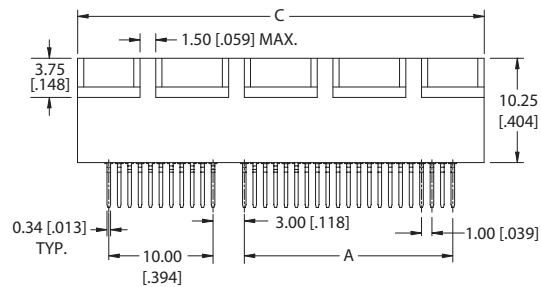
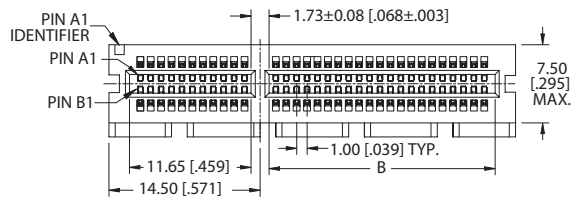

STRADDLE MOUNT without PEGS
Example Part Number: *GBE18DHRN-T941*

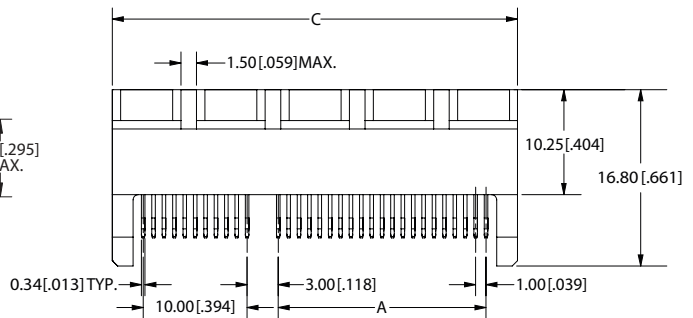
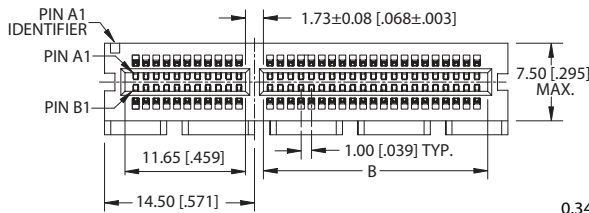

STRADDLE MOUNT with PEGS
Example Part Number: *GBE18DHRN-T9410*

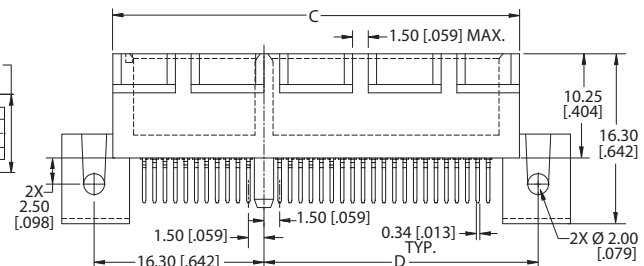
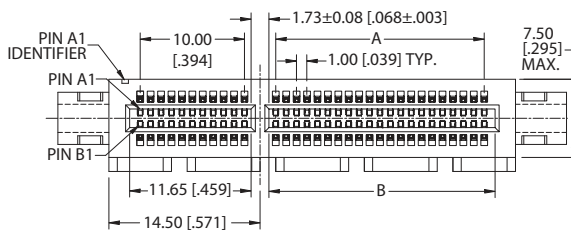

STRADDLE MOUNT with CLIPS
Example Part Number: *GBE18DHRQ-T941*

| POSITIONS/ CONTACTS | MILLIMETERS | | | | INCHES | | | |
|------------------------|-------------|-------|-------|-------|--------|-------|-------|-------|
| | A | B | C | D | A | B | C | D |
| 18/36 | 6.00 | 7.65 | 25.00 | 12.30 | 0.236 | 0.301 | 0.984 | 0.484 |
| 32/64 | 20.00 | 21.65 | 39.00 | 26.30 | 0.787 | 0.852 | 1.535 | 1.035 |
| 49/98 | 37.00 | 38.65 | 56.00 | 43.30 | 1.457 | 1.522 | 2.205 | 1.705 |
| 82/164 | 70.00 | 71.65 | 89.00 | 76.30 | 2.756 | 2.821 | 3.504 | 3.004 |



PART NUMBER OPTIONS

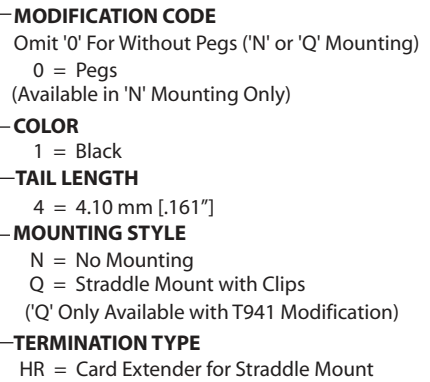
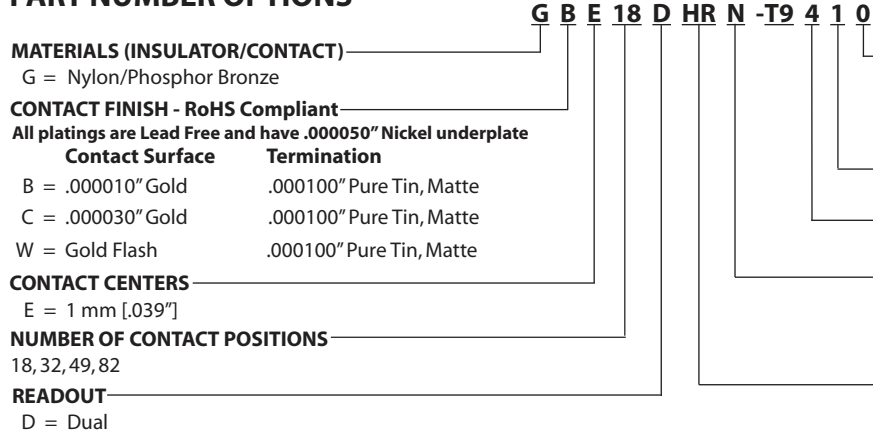

Operating & Processing Temperature: Consult Factory

SPECIFICATIONS

- All PCI Express parts meet the latest PCI Express specifications
- Supports 2.5 GT/s, 5.0 GT/s or 8.0 GT/s Data Transfer Rate (per pair data bandwidth)
- Accommodates 1.57 mm [.062"] PC board
- 1.1 Amp current rating per contact
- UL Flammability Rating: 94V-0

