

# RIF-2-RSC-LV-230AC/4X21 - Relay Module



2903316

<https://www.phoenixcontact.com/us/products/2903316>

Please be informed that the data shown in this PDF document is generated from our online catalog. Please find the complete data in the user documentation. Our general terms of use for downloads are valid.



Preassembled relay module with screw connection, consisting of: relay base, power contact relay, plug-in display/interference suppression module, and retaining bracket. Contact switching type: 4 changeover contacts. Input voltage: 230 V AC

## Product description

The pluggable electromechanical and solid-state relays in the RIFLINE complete product range and the base are recognized and approved in accordance with UL 508. The relevant approvals can be called up at the individual components in question.

## Commercial data

Item number	2903316
Packing unit	1 pc
Minimum order quantity	10 pc
Sales key	C465
Product key	CK651A
Catalog page	Page 343 (C-5-2019)
GTIN	4046356732185
Weight per piece (including packing)	116.4 g
Weight per piece (excluding packing)	116.4 g
Customs tariff number	85364900
Country of origin	CN

# RIF-2-RSC-LV-230AC/4X21 - Relay Module



2903316

<https://www.phoenixcontact.com/us/products/2903316>

## Technical data

### Product properties

Product type	Relay Module
Product family	RIFLINE complete
Application	Universal
Operating mode	100% operating factor
Mechanical service life	approx. $2 \times 10^7$ cycles

### Insulation characteristics

Insulation	Basic insulation
------------	------------------

### Insulation characteristics

Insulation	Basic insulation
Overvoltage category	II
Pollution degree	2

### Electrical properties

Maximum power dissipation for nominal condition	1.5 W
Test voltage (Winding/contact)	2.5 kV <sub>rms</sub> (50 Hz, 1 min., winding/contact)
Test voltage (Contact/contact)	2 kV <sub>rms</sub> (50 Hz, 1 min., contact/contact)
Rated insulation voltage	250 V AC
Rated surge voltage	2.5 kV

### Input data

#### Coil side

Nominal input voltage $U_N$	230 V AC
Input voltage range	184 V AC ... 276 V AC (20 °C)
Input voltage range in reference to $U_N$	see diagram
Mains frequency	50/60 Hz
Drive and function	monostable
Drive (polarity)	polarized
Typical input current at $U_N$	6.5 mA
Typical response time	5 ms ... 15 ms
Typical release time range	5 ms ... 20 ms
Coil voltage	230 V AC
Protective circuit	Varistor
Operating voltage display	Yellow LED

### Output data

#### Switching

Contact switching type	4 changeover contacts
Type of switch contact	Single contact

# RIF-2-RSC-LV-230AC/4X21 - Relay Module



2903316

<https://www.phoenixcontact.com/us/products/2903316>

Contact material	AgNi
Maximum switching voltage	250 V AC/DC
Minimum switching voltage	5 V (24 mA)
Limiting continuous current	5 A (see diagram)
Maximum inrush current	16 A (20 ms, N/O contacts)
Min. switching current	5 mA (24 V)
Interrupting rating (ohmic load) max.	120 W (24 V DC)
	124 W (48 V DC)
	108 W (60 V DC)
	52 W (110 V DC)
	48 W (220 V DC)
	1250 VA (250 V AC)
Utilization category CB Scheme (IEC 60947-5-1)	AC15, 1 A/240 V (N/O contact)
	DC13, 2 A/24 V (N/O contact)

## Connection data

Connection method	Screw connection
Stripping length	8 mm
Conductor cross section rigid	0.5 mm <sup>2</sup> ... 4 mm <sup>2</sup>
Conductor cross-section rigid (2 conductors with same cross section)	0.5 mm <sup>2</sup> ... 2.5 mm <sup>2</sup>
Conductor cross section flexible	0.5 mm <sup>2</sup> ... 4 mm <sup>2</sup>
	0.5 mm <sup>2</sup> ... 4 mm <sup>2</sup> (Ferrule with plastic sleeve)
Conductor cross section flexible (2 conductors with same cross section)	0.5 mm <sup>2</sup> ... 2.5 mm <sup>2</sup>
	0.5 mm <sup>2</sup> ... 1.5 mm <sup>2</sup> (TWIN ferrule with plastic sleeve)
Conductor cross section AWG	20 ... 10 (solid)
	20 ... 12 (flexible)
Tightening torque	0.5 Nm ... 0.6 Nm

## Dimensions

Width	27 mm
Height	89 mm
Depth	75 mm

## Material specifications

Flammability rating according to UL 94	V2 (Housing)
--	--------------

## Environmental and real-life conditions

### Ambient conditions

Degree of protection (Relay base)	IP20 (Relay base)
Degree of protection (Relay)	RT I (Relay)
Ambient temperature (operation)	-40 °C ... 50 °C
Ambient temperature (storage/transport)	-40 °C ... 85 °C

# RIF-2-RSC-LV-230AC/4X21 - Relay Module



2903316

<https://www.phoenixcontact.com/us/products/2903316>

## Approvals

### Corrosive gas test

Identification	ISA-S71.04. G3 Harsh Group
	EN 60068-2-60

## Standards and regulations

Standards/regulations	IEC 60947-5-1
-----------------------	---------------

## Mounting

Mounting type	DIN rail mounting
Assembly instructions	in rows with zero spacing
Mounting position	any

## Drawings

Diagram

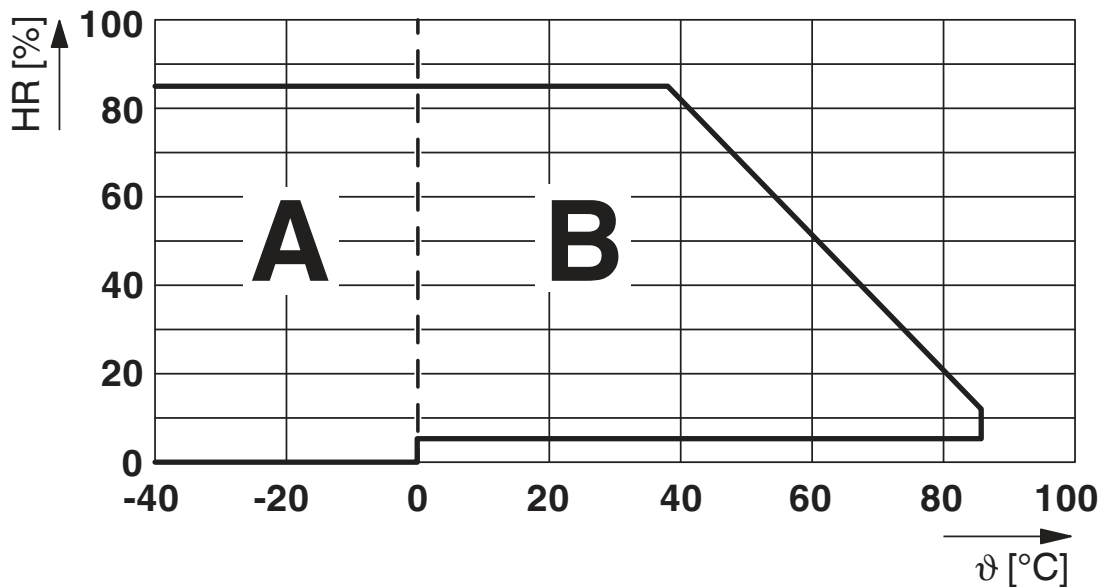

Permissible humidity for operation and storage.

The maximum permissible ambient temperature as specified in the data sheet must be observed.

Area A: Ice buildup at ambient temperatures  $\leq 0^\circ\text{C}$  must be prevented

Area B: Condensation at ambient temperatures  $> 0^\circ\text{C}$  must be prevented

On 30 full days that are naturally distributed across an entire year, a humidity level of 95% is permissible at an ambient temperature  $\leq 25^\circ\text{C}$ .

2903316

<https://www.phoenixcontact.com/us/products/2903316>

Diagram

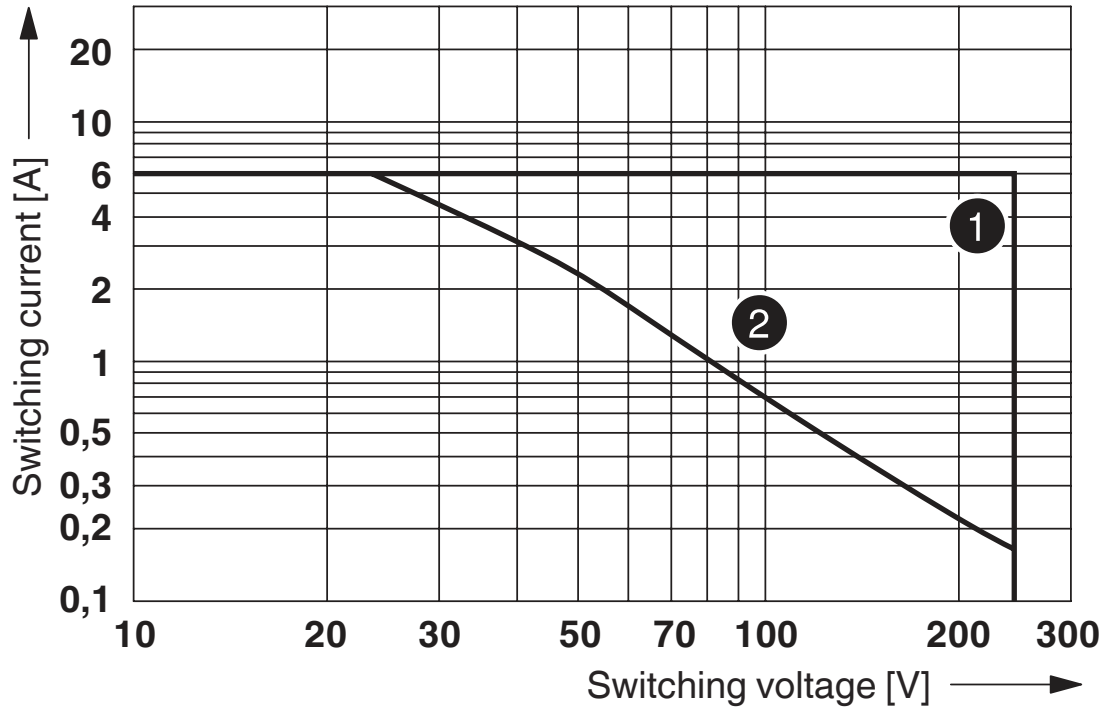

- ① AC, ohmic load
- ② DC, ohmic load

Interrupting rating

Diagram

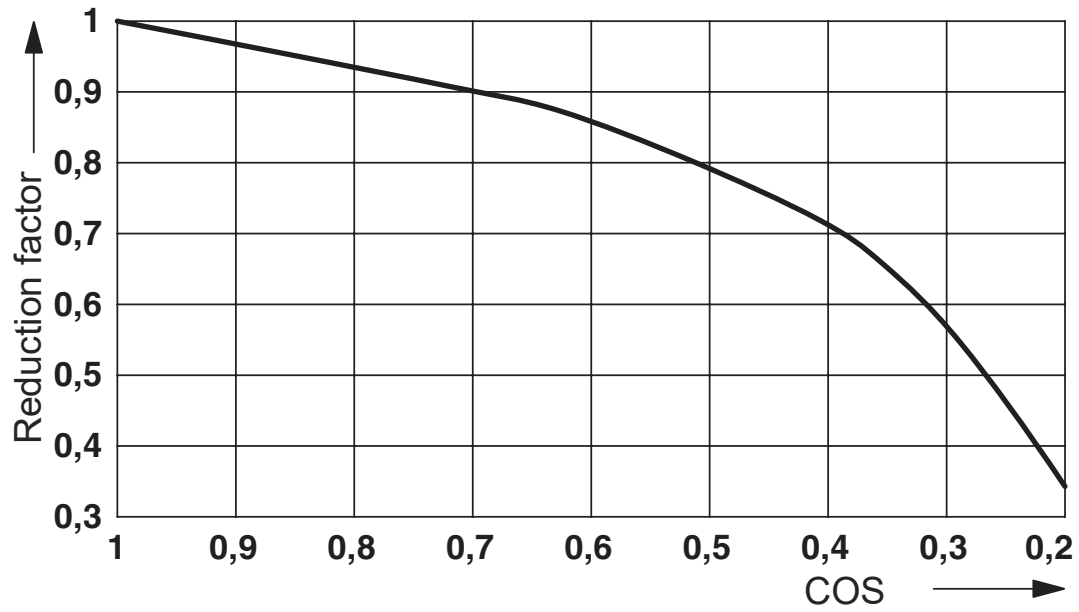

Service life reduction factor

Diagram

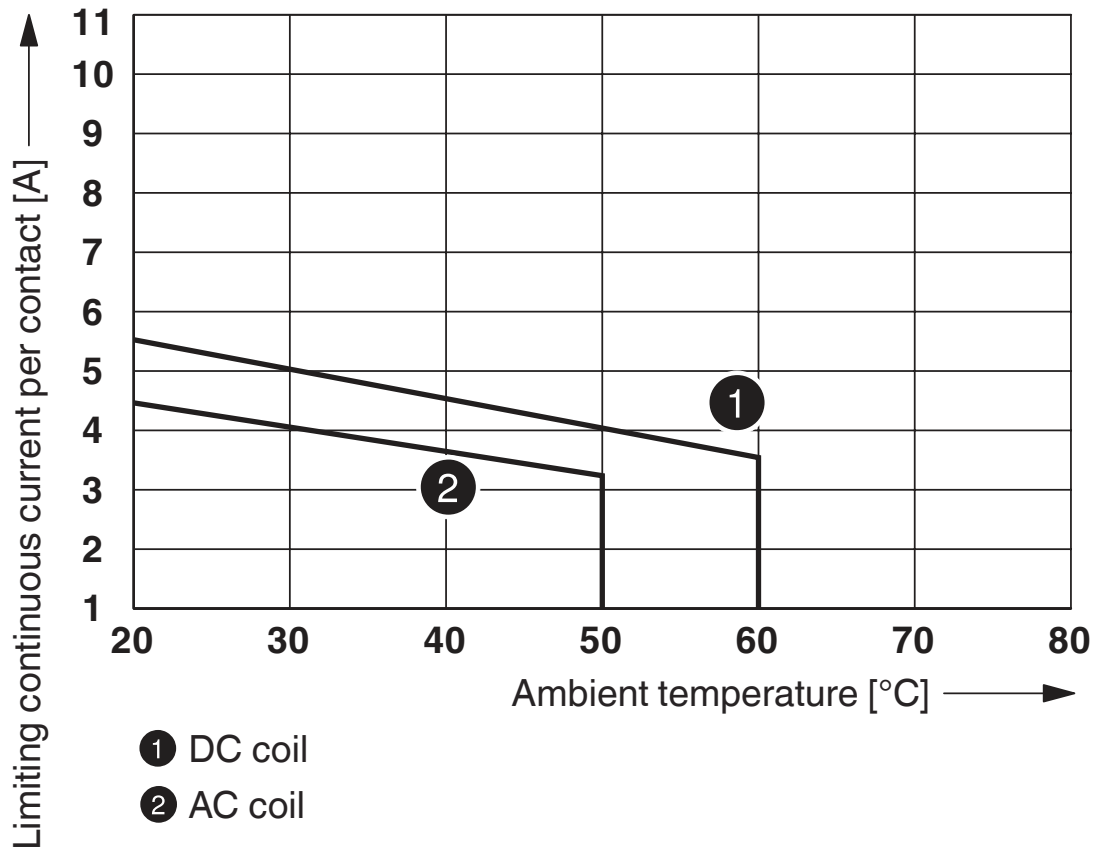

Contact derating



Diagram

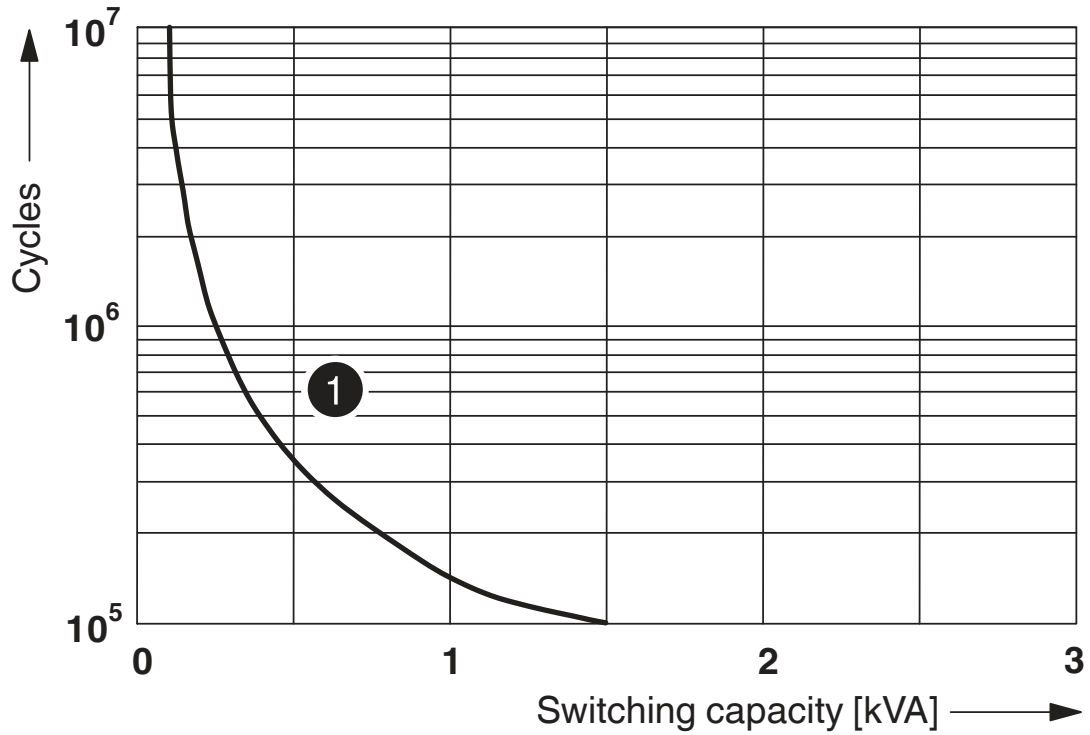

① 250 V AC, Ohmic load

Electrical service life

# RIF-2-RSC-LV-230AC/4X21 - Relay Module



2903316

<https://www.phoenixcontact.com/us/products/2903316>

Circuit diagram

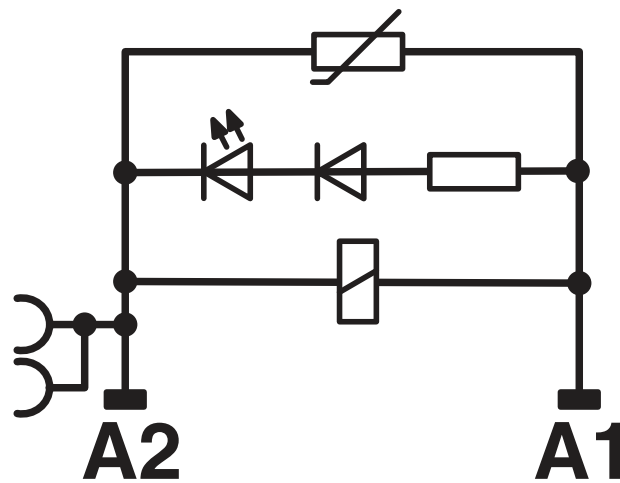
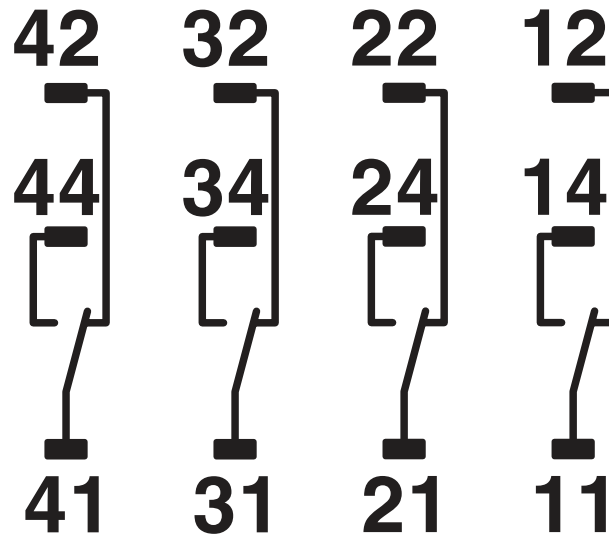

Diagram

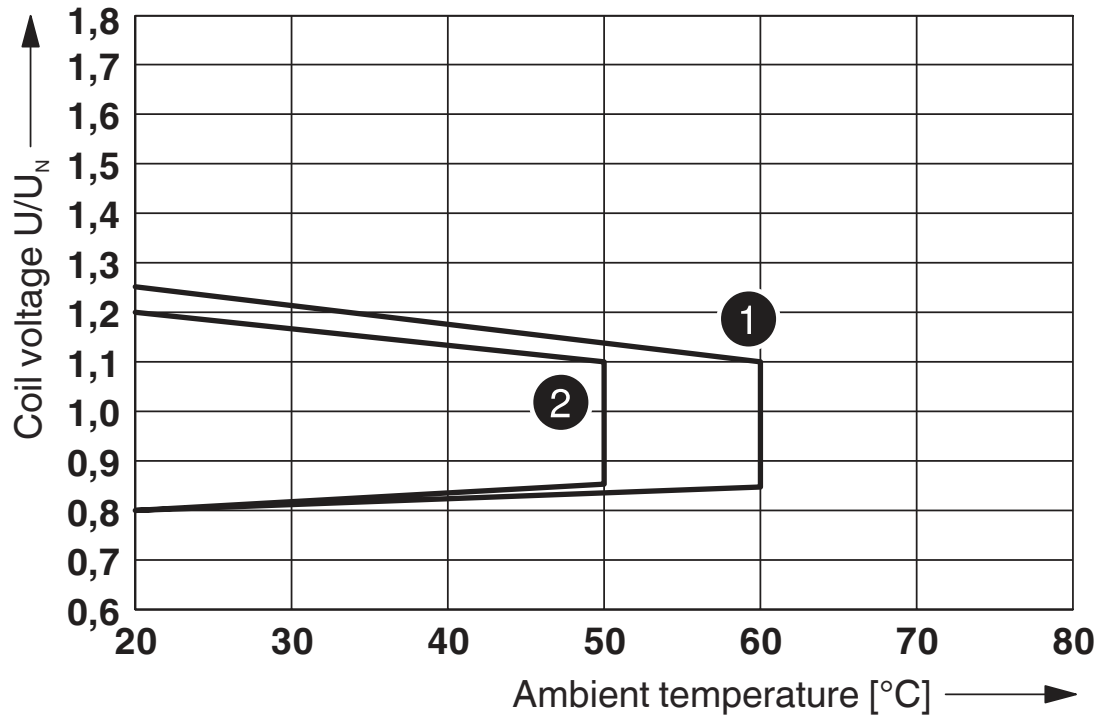

- ① DC coil (observe contact derating)
- ② AC coil (observe contact derating)

Operating voltage range

# RIF-2-RSC-LV-230AC/4X21 - Relay Module



2903316

<https://www.phoenixcontact.com/us/products/2903316>

## Approvals

To download certificates, visit the product detail page: <https://www.phoenixcontact.com/us/products/2903316>



**CSA**

Approval ID: 76787



**EAC**

Approval ID: TR\_TS\_D\_00573\_c



**DNV GL**

Approval ID: TAA000018V



**EAC**

Approval ID: RU\*C-DE.\*08.B.00010

# RIF-2-RSC-LV-230AC/4X21 - Relay Module



2903316

<https://www.phoenixcontact.com/us/products/2903316>

## Classifications

### ECLASS

ECLASS-11.0	27371601
ECLASS-12.0	27371601
ECLASS-13.0	27371601

### ETIM

ETIM 8.0	EC001437
----------	----------

### UNSPSC

UNSPSC 21.0	39122300
-------------	----------

# RIF-2-RSC-LV-230AC/4X21 - Relay Module



2903316

<https://www.phoenixcontact.com/us/products/2903316>

## Environmental product compliance

China RoHS	Environmentally friendly use period: unlimited = EFUP-e
	No hazardous substances above threshold values

# RIF-2-RSC-LV-230AC/4X21 - Relay Module



2903316

<https://www.phoenixcontact.com/us/products/2903316>

## Accessories

### FBS 2-6 - Plug-in bridge

3030336

<https://www.phoenixcontact.com/us/products/3030336>



Plug-in bridge, pitch: 6.2 mm, number of positions: 2, color: red

---

### FBS 2-6 BU - Plug-in bridge

3036932

<https://www.phoenixcontact.com/us/products/3036932>



Plug-in bridge, pitch: 6.2 mm, number of positions: 2, color: blue

# RIF-2-RSC-LV-230AC/4X21 - Relay Module



2903316

<https://www.phoenixcontact.com/us/products/2903316>

## FBS 2-6 GY - Plug-in bridge

3032237

<https://www.phoenixcontact.com/us/products/3032237>



Plug-in bridge, pitch: 6.2 mm, number of positions: 2, color: gray

---

## STP 5-2 - Marker carriers

0800967

<https://www.phoenixcontact.com/us/products/0800967>



Marker carriers, snaps into STTB 2,5, STTB 4, PTTB 2,5, and PTTB 4 double-level spring-cage terminal blocks, can be marked with UC-TM 5, UC-TMF 5, UCT-TM 5, UCT-TMF 5, ZB 5, or ZBF 5, gray, unlabeled, mounting type: plug in, lettering field size: 5 x 10.5 mm



# RIF-2-RSC-LV-230AC/4X21 - Relay Module



2903316

<https://www.phoenixcontact.com/us/products/2903316>

## NS 35/ 7,5 PERF 2000MM - DIN rail perforated

0801733

<https://www.phoenixcontact.com/us/products/0801733>



DIN rail perforated, acc. to EN 60715, material: Steel, galvanized, passivated with a thick layer, Standard profile, color: silver, Pack of 25 (50 m)

---

## NS 35/ 7,5 UNPERF 2000MM - DIN rail, unperforated

0801681

<https://www.phoenixcontact.com/us/products/0801681>



DIN rail, unperforated, acc. to EN 60715, material: Steel, galvanized, passivated with a thick layer, Standard profile, color: silver, Pack of 25 (50 m)

# RIF-2-RSC-LV-230AC/4X21 - Relay Module



2903316

<https://www.phoenixcontact.com/us/products/2903316>

## NS 35/ 7,5 WH PERF 2000MM - DIN rail perforated

1204119

<https://www.phoenixcontact.com/us/products/1204119>



DIN rail perforated, acc. to EN 60715, material: Steel, Galvanized, white passivated, Standard profile, color: silver, Pack of 25 (50 m)

---

## NS 35/ 7,5 WH UNPERF 2000MM-VPE 10 - DIN rail, unperforated

1204122

<https://www.phoenixcontact.com/us/products/1204122>



DIN rail, unperforated, acc. to EN 60715, material: Steel, Galvanized, white passivated, Standard profile, color: silver, Pack of 10 (20 m)

# RIF-2-RSC-LV-230AC/4X21 - Relay Module

2903316

<https://www.phoenixcontact.com/us/products/2903316>

## NS 35/ 7,5 AL UNPERF 2000MM - DIN rail, unperforated

0801704

<https://www.phoenixcontact.com/us/products/0801704>



DIN rail, unperforated, acc. to EN 60715, material: Aluminum, uncoated, Standard profile, color: silver, Pack of 25 (50 m)

---

## NS 35/ 7,5 ZN PERF 2000MM - DIN rail perforated

1206421

<https://www.phoenixcontact.com/us/products/1206421>



DIN rail perforated, acc. to EN 60715, material: Steel, galvanized, Standard profile, color: silver, Pack of 25 (50 m)

# RIF-2-RSC-LV-230AC/4X21 - Relay Module

2903316

<https://www.phoenixcontact.com/us/products/2903316>

## NS 35/ 7,5 ZN UNPERF 2000MM - DIN rail, unperforated

1206434

<https://www.phoenixcontact.com/us/products/1206434>



DIN rail, unperforated, acc. to EN 60715, material: Steel, galvanized, Standard profile, color: silver, Pack of 25 (50 m)

---

## NS 35/ 7,5 CU UNPERF 2000MM-VPE 10 - DIN rail, unperforated

0801762

<https://www.phoenixcontact.com/us/products/0801762>



DIN rail, unperforated, acc. to EN 60715, material: Copper, uncoated, Standard profile, color: copper-colored, Pack of 10 (20 m)

# RIF-2-RSC-LV-230AC/4X21 - Relay Module



2903316

<https://www.phoenixcontact.com/us/products/2903316>

## NS 35/ 7,5 CAP - End cap

1206560

<https://www.phoenixcontact.com/us/products/1206560>

DIN rail end piece, for DIN rail NS 35/7.5



---

## NS 35/15 PERF 2000MM - DIN rail perforated

1201730

<https://www.phoenixcontact.com/us/products/1201730>



DIN rail perforated, similar to EN 60715, material: Steel, galvanized, passivated with a thick layer, Standard profile, color: silver, Pack of 25 (50 m)

# RIF-2-RSC-LV-230AC/4X21 - Relay Module



2903316

<https://www.phoenixcontact.com/us/products/2903316>

## NS 35/15 UNPERF 2000MM - DIN rail, unperforated

1201714

<https://www.phoenixcontact.com/us/products/1201714>



DIN rail, unperforated, similar to EN 60715, material: Steel, galvanized, passivated with a thick layer, Standard profile, color: silver, Pack of 25 (50 m)

---

## NS 35/15 WH PERF 2000MM - DIN rail perforated

0806602

<https://www.phoenixcontact.com/us/products/0806602>



DIN rail perforated, similar to EN 60715, material: Steel, Galvanized, white passivated, Standard profile, color: white, Pack of 25 (50 m)

# RIF-2-RSC-LV-230AC/4X21 - Relay Module



2903316

<https://www.phoenixcontact.com/us/products/2903316>

## NS 35/15 WH UNPERF 2000MM-VPE 10 - DIN rail, unperforated

1204135

<https://www.phoenixcontact.com/us/products/1204135>



DIN rail, unperforated, similar to EN 60715, material: Steel, Galvanized, white passivated, Standard profile, color: silver, Pack of 10 (20 m)

---

## NS 35/15 AL UNPERF 2000MM - DIN rail, unperforated

1201756

<https://www.phoenixcontact.com/us/products/1201756>



DIN rail, unperforated, similar to EN 60715, material: Aluminum, uncoated, Standard profile, color: silver

# RIF-2-RSC-LV-230AC/4X21 - Relay Module



2903316

<https://www.phoenixcontact.com/us/products/2903316>

## NS 35/15 ZN PERF 2000MM - DIN rail perforated

1206599

<https://www.phoenixcontact.com/us/products/1206599>



DIN rail perforated, similar to EN 60715, material: Steel, galvanized, Standard profile, color: silver, Pack of 25 (50 m)

---

## NS 35/15 ZN UNPERF 2000MM - DIN rail, unperforated

1206586

<https://www.phoenixcontact.com/us/products/1206586>



DIN rail, unperforated, similar to EN 60715, material: Steel, galvanized, Standard profile, color: silver, Pack of 25 (50 m)



# RIF-2-RSC-LV-230AC/4X21 - Relay Module



2903316

<https://www.phoenixcontact.com/us/products/2903316>

## NS 35/15 CU UNPERF 2000MM-VPE 10 - DIN rail, unperforated

1201895

<https://www.phoenixcontact.com/us/products/1201895>



DIN rail, unperforated, similar to EN 60715, material: Copper, uncoated, Standard profile, color: copper-colored, Pack of 10 (20 m)

---

## NS 35/15 CAP - End cap

1206573

<https://www.phoenixcontact.com/us/products/1206573>

DIN rail end piece, for DIN rail NS 35/15



# RIF-2-RSC-LV-230AC/4X21 - Relay Module



2903316

<https://www.phoenixcontact.com/us/products/2903316>

## NS 35/15-2,3 UNPERF 2000MM-VPE 10 - DIN rail, unperforated

1201798

<https://www.phoenixcontact.com/us/products/1201798>



DIN rail, unperforated, acc. to EN 60715, material: Steel, galvanized, passivated with a thick layer, Standard profile 2.3 mm, color: silver, Pack of 10 (20 m)

---

## CLIPFIX 35 - End clamp

3022218

<https://www.phoenixcontact.com/us/products/3022218>



Quick mounting end clamp for NS 35/7,5 DIN rail or NS 35/15 DIN rail, with marking option, width: 9.5 mm, color: gray

# RIF-2-RSC-LV-230AC/4X21 - Relay Module

2903316

<https://www.phoenixcontact.com/us/products/2903316>

## CLIPFIX 35-5 - End clamp

3022276

<https://www.phoenixcontact.com/us/products/3022276>



Quick mounting end clamp for NS 35/7,5 DIN rail or NS 35/15 DIN rail, with marking option, with parking option for FBS...5, FBS...6, KSS 5, KSS 6, width: 5.15 mm, color: gray

---

## E/NS 35 N - End clamp

0800886

<https://www.phoenixcontact.com/us/products/0800886>



End clamp, width: 9.5 mm, color: gray

# RIF-2-RSC-LV-230AC/4X21 - Relay Module



2903316

<https://www.phoenixcontact.com/us/products/2903316>

## MPS-MT - Test plugs

0201744

<https://www.phoenixcontact.com/us/products/0201744>



Test plugs, with solder connection up to 1 mm<sup>2</sup> conductor cross section, number of positions: 1, color: gray

---

## MPS-IH WH - Insulating sleeve

0201663

<https://www.phoenixcontact.com/us/products/0201663>

Insulating sleeve, color: white



# RIF-2-RSC-LV-230AC/4X21 - Relay Module



2903316

<https://www.phoenixcontact.com/us/products/2903316>

## MPS-IH RD - Insulating sleeve

0201676

<https://www.phoenixcontact.com/us/products/0201676>

Insulating sleeve, color: red



---

## MPS-IH BU - Insulating sleeve

0201689

<https://www.phoenixcontact.com/us/products/0201689>

Insulating sleeve, color: blue



# RIF-2-RSC-LV-230AC/4X21 - Relay Module



2903316

<https://www.phoenixcontact.com/us/products/2903316>

## MPS-IH YE - Insulating sleeve

0201692

<https://www.phoenixcontact.com/us/products/0201692>

Insulating sleeve, color: yellow



---

## MPS-IH GN - Insulating sleeve

0201702

<https://www.phoenixcontact.com/us/products/0201702>

Insulating sleeve, color: green



# RIF-2-RSC-LV-230AC/4X21 - Relay Module



2903316

<https://www.phoenixcontact.com/us/products/2903316>

## MPS-IH GY - Insulating sleeve

0201728

<https://www.phoenixcontact.com/us/products/0201728>

Insulating sleeve, color: gray



---

## MPS-IH BK - Insulating sleeve

0201731

<https://www.phoenixcontact.com/us/products/0201731>

Insulating sleeve, color: black



# RIF-2-RSC-LV-230AC/4X21 - Relay Module

2903316

<https://www.phoenixcontact.com/us/products/2903316>

## ZB 5 :UNBEDRUCKT - Zack marker strip

1050004

<https://www.phoenixcontact.com/us/products/1050004>



Zack marker strip, Strip, white, unlabeled, can be labeled with: PLOTMARK, CMS-P1-PLOTTER, mounting type: snapped, for terminal block width: 5.2 mm, lettering field size: 5.1 x 10.5 mm, Number of individual labels: 10

---

## ZB 5 CUS - Zack marker strip

0824962

<https://www.phoenixcontact.com/us/products/0824962>



Zack marker strip, can be ordered: Strip, white, labeled according to customer specifications, mounting type: snap into tall marker groove, for terminal block width: 5.2 mm, lettering field size: 5.15 x 10.5 mm, Number of individual labels: 10



# RIF-2-RSC-LV-230AC/4X21 - Relay Module



2903316

<https://www.phoenixcontact.com/us/products/2903316>

## ZB 5,LGS:FORTL.ZAHLEN - Zack marker strip

1050017

<https://www.phoenixcontact.com/us/products/1050017>



Zack marker strip, Strip, white, labeled, printed horizontally: consecutive numbers 1 ... 10, 11 ... 20, etc. up to 491 ... 500, mounting type: snapped, for terminal block width: 5.2 mm, lettering field size: 5.15 x 10.5 mm, Number of individual labels: 10

---

## ZB 5,QR:FORTL.ZAHLEN - Zack marker strip

1050020

<https://www.phoenixcontact.com/us/products/1050020>



Zack marker strip, white, Printed vertically: consecutive numbers 1 ... 10, 11 ... 20, etc. up to 491 ... 500, mounting type: snapped, for terminal block width: 5.2 mm, lettering field size: 5.15 x 10.5 mm

# RIF-2-RSC-LV-230AC/4X21 - Relay Module

2903316

<https://www.phoenixcontact.com/us/products/2903316>

## ZB 5,LGS:GLEICHE ZAHLEN - Zack marker strip

1050033

<https://www.phoenixcontact.com/us/products/1050033>



Zack marker strip, Strip, white, labeled, can be labeled with: CMS-P1-PLOTTER, printed horizontally: Identical numbers 1 or 2, etc. up to 100, mounting type: snapped, for terminal block width: 5.2 mm, lettering field size: 5.15 x 10.5 mm, Number of individual labels: 10

---

## ZB 5,LGS:L1-N,PE - Zack marker strip

1050415

<https://www.phoenixcontact.com/us/products/1050415>



Zack marker strip, Strip, white, labeled, horizontal: L1, L2, L3, N, PE, L1, L2, L3, N, PE, mounting type: snapped, for terminal block width: 5.2 mm, lettering field size: 5.15 x 10.5 mm, Number of individual labels: 10

# RIF-2-RSC-LV-230AC/4X21 - Relay Module



2903316

<https://www.phoenixcontact.com/us/products/2903316>

## UC-TM 5 - Marker for terminal blocks

0818108

<https://www.phoenixcontact.com/us/products/0818108>



Marker for terminal blocks, Sheet, white, unlabeled, can be labeled with: BLUEMARK ID COLOR, BLUEMARK ID, BLUEMARK CLED, PLOTMARK, CMS-P1-PLOTTER, mounting type: snapped, for terminal block width: 5.2 mm, lettering field size: 4.6 x 10.5 mm, Number of individual labels: 96

---

## UC-TM 5 CUS - Marker for terminal blocks

0824581

<https://www.phoenixcontact.com/us/products/0824581>



Marker for terminal blocks, can be ordered: by sheet, white, labeled according to customer specifications, mounting type: snap into tall marker groove, for terminal block width: 5.2 mm, lettering field size: 10.5 x 4.6 mm, Number of individual labels: 96

# RIF-2-RSC-LV-230AC/4X21 - Relay Module



2903316

<https://www.phoenixcontact.com/us/products/2903316>

## UCT-TM 5 - Marker for terminal blocks

0828734

<https://www.phoenixcontact.com/us/products/0828734>



Marker for terminal blocks, Sheet, white, unlabeled, can be labeled with: TOPMARK NEO, TOPMARK LASER, BLUEMARK ID COLOR, BLUEMARK ID, BLUEMARK CLED, THERMOMARK PRIME, THERMOMARK CARD 2.0, THERMOMARK CARD, mounting type: snapped, for terminal block width: 5.2 mm, lettering field size: 4.6 x 10.5 mm, Number of individual labels: 72

---

## UCT-TM 5 CUS - Marker for terminal blocks

0829595

<https://www.phoenixcontact.com/us/products/0829595>



Marker for terminal blocks, can be ordered: by sheet, white, labeled according to customer specifications, mounting type: snap into tall marker groove, for terminal block width: 5.2 mm, lettering field size: 4.6 x 10.5 mm, Number of individual labels: 72

# RIF-2-RSC-LV-230AC/4X21 - Relay Module



2903316

<https://www.phoenixcontact.com/us/products/2903316>

## GBS 5-25X12 - Group marker label for terminal marking

0810588

<https://www.phoenixcontact.com/us/products/0810588>



Group marker label, snaps onto terminal center for screw, spring-cage and quick connection terminal blocks, labeled with a 25 x 12 mm label or manually with the B-STIFT, in the foot part with ZB 5

---

## GBS 5-25X5 - Group marker label for terminal marking

0829126

<https://www.phoenixcontact.com/us/products/0829126>



Group marking label, can be snapped into terminal center for screw, spring-cage, push-in, and fast connection terminal blocks, can be labeled with a 24 x 4 mm label or manually using B-STIFT, in the foot part with ZB 5

# RIF-2-RSC-LV-230AC/4X21 - Relay Module



2903316

<https://www.phoenixcontact.com/us/products/2903316>

## STP 5-2-ZB - Marker carriers

3037643

<https://www.phoenixcontact.com/us/products/3037643>



Marker carriers, snaps into ST 2,5 spring-cage terminal blocks, can be marked with UC-TM 5, UC-TMF 5, UCT-TM 5, UCT-TMF 5, ZB 5, or ZBF 5, gray, unlabeled, mounting type: snapped

---

## ZB 15:UNBEDRUCKT - Zack marker strip

0811972

<https://www.phoenixcontact.com/us/products/0811972>



Zack marker strip, Strip, white, unlabeled, can be labeled with: PLOTMARK, CMS-P1-PLOTTER, mounting type: snapped, for terminal block width: 15.2 mm, lettering field size: 10.5 x 15.1 mm, Number of individual labels: 5

# RIF-2-RSC-LV-230AC/4X21 - Relay Module



2903316

<https://www.phoenixcontact.com/us/products/2903316>

## ZB 15 CUS - Zack marker strip

0824945

<https://www.phoenixcontact.com/us/products/0824945>



Zack marker strip, can be ordered: Strip, white, labeled according to customer specifications, mounting type: snap into tall marker groove, for terminal block width: 15.2 mm, lettering field size: 10.5 x 15.1 mm, Number of individual labels: 5

---

## ZB 15,LGS:L1-N,PE - Zack marker strip

0811998

<https://www.phoenixcontact.com/us/products/0811998>



Zack marker strip, Strip, white, labeled, printed horizontally: L1, L2, L3, N, PE, mounting type: snapped, for terminal block width: 15.2 mm, lettering field size: 10.5 x 15.1 mm, Number of individual labels: 5

# RIF-2-RSC-LV-230AC/4X21 - Relay Module



2903316

<https://www.phoenixcontact.com/us/products/2903316>

## UC-TM 16 - Marker for terminal blocks

0819217

<https://www.phoenixcontact.com/us/products/0819217>



Marker for terminal blocks, Sheet, white, unlabeled, can be labeled with: BLUEMARK ID COLOR, BLUEMARK ID, BLUEMARK CLED, PLOTMARK, CMS-P1-PLOTTER, mounting type: snapped, for terminal block width: 16 mm, lettering field size: 15.45 x 10.5 mm, Number of individual labels: 32

---

## UC-TMF 16 - Marker for terminal blocks

0819262

<https://www.phoenixcontact.com/us/products/0819262>



Marker for terminal blocks, Sheet, white, unlabeled, can be labeled with: BLUEMARK ID COLOR, BLUEMARK ID, BLUEMARK CLED, PLOTMARK, CMS-P1-PLOTTER, mounting type: snapped, for terminal block width: 16 mm, lettering field size: 15.45 x 5.1 mm, Number of individual labels: 32



# RIF-2-RSC-LV-230AC/4X21 - Relay Module

2903316

<https://www.phoenixcontact.com/us/products/2903316>



## RIF-2-BSC/4X21 - Relay base

2900932

<https://www.phoenixcontact.com/us/products/2900932>



RIF-2... relay base, for industrial relay with 2 or 4 changeover contacts, screw connection, plug-in option for input/interference suppression modules, for mounting on NS 35/7,5

---

## REL-IR4/L-230AC/4X21 - Single relay

2903688

<https://www.phoenixcontact.com/us/products/2903688>



Plug-in industrial relay with power contacts, 4 changeover contacts, test button, status LED, mechanical switching position indicator, input voltage: 230 V AC

# RIF-2-RSC-LV-230AC/4X21 - Relay Module



2903316

<https://www.phoenixcontact.com/us/products/2903316>

## RIF-V-120-230 UC - Plug-in module

2900948

<https://www.phoenixcontact.com/us/products/2900948>



Plug-in module, for mounting on RIF-1, RIF-2, RIF-3, and RIF-4, with varistor, input voltage: 120 V AC ... 230 V AC / DC  $\pm 20\%$

---

## RIF-RH-2 - Retaining bracket

2900954

<https://www.phoenixcontact.com/us/products/2900954>



Relay retaining bracket, with ejector function and holder for marking material, suitable for RIF-2 relay base, for industrial relay

---

Phoenix Contact 2023 © - all rights reserved  
<https://www.phoenixcontact.com>

Phoenix Contact USA  
586 Fulling Mill Road  
Middletown, PA 17057, United States  
(+717) 944-1300  
[info@phoenixcon.com](mailto:info@phoenixcon.com)