

# NOA2301W

## Digital Proximity Sensor with Interrupt

### Description

The NOA2301W combines an advanced digital proximity sensor and LED driver coupled with a tri-mode I<sup>2</sup>C interface with interrupt capability in an integrated monolithic device. Multiple power management features and very low active sensing power consumption directly address the power requirements of battery operated mobile phones and mobile internet devices.

The proximity sensor measures reflected light intensity with a high degree of precision and excellent ambient light rejection. The NOA2301W enables a proximity sensor system with a 16:1 programmable LED drive current range and a 30 dB overall proximity detection range.

The NOA2301W is ideal for improving the user experience by enhancing the screen interface with the ability to measure distance for near/far detection in real time.

### Features

- Proximity Sensor and LED Driver in One Device
- Proximity Detection Distance Threshold I<sup>2</sup>C Programmable with 12-bit Resolution and Eight Integration Time Ranges (16-bit effective resolution)
- Effective for Measuring Distances up to 200 mm and Beyond
- Excellent IR and Ambient Light Rejection including Sunlight (up to 50K lux) and CFL Interference
- Programmable LED Drive Current from 10 mA to 160 mA in 5 mA Steps, No External Resistor Required
- User Programmable LED Pulse Frequency
- Very Low Power Consumption
  - ◆ Stand-by current 2.8  $\mu$ A (monitoring I<sup>2</sup>C interface only, V<sub>dd</sub>=3V)
  - ◆ Proximity sensing average operational current 100  $\mu$ A
  - ◆ Average LED sink current 75  $\mu$ A
- Programmable interrupt function including independent upper and lower threshold detection or threshold based hysteresis
- Level or Edge Triggered Interrupts
- Proximity persistence feature reduces interrupts by providing hysteresis to filter fast transients such as camera flash
- Automatic power down after single measurement or continuous measurements with programmable interval time
- Wide Operating Voltage Range (2.3 V to 3.6 V)
- Wide Operating Temperature Range (-40°C to 80°C)
- I<sup>2</sup>C Serial Communication Port
  - ◆ Standard mode – 100 kHz
  - ◆ Fast mode – 400 kHz
  - ◆ High speed mode – 3.4 MHz



ON Semiconductor®

[www.onsemi.com](http://www.onsemi.com)

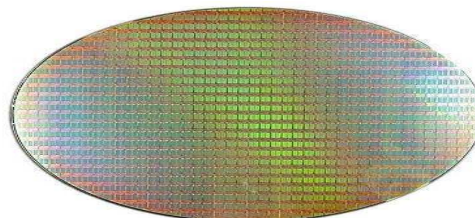

AMBIENT LIGHT PROXIMITY SENSOR

### ORDERING INFORMATION

Device	Wafer Size	Temp Range
NOA2301W	200 mm wafer	-40°C to 80°C

- No External Components Required except the IR LED and Power Supply Decoupling Caps
- These Devices are Pb-Free, Halogen Free/BFR Free and are RoHS Compliant

### Applications

- Senses human presence in terms of distance for saving display power and preventing inadvertent command initiation in applications such as:
  - ◆ Smart phones, mobile internet devices, MP3 players, GPS
  - ◆ Mobile device displays and backlit keypads
  - ◆ Headphone use detection
  - ◆ Cameras
  - ◆ Game controllers, media players
- Contactless Switches
  - ◆ Touch-less switches for light controls
  - ◆ Money detection, coin or paper
  - ◆ Sanitary switches for medical environments

# NOA2301W

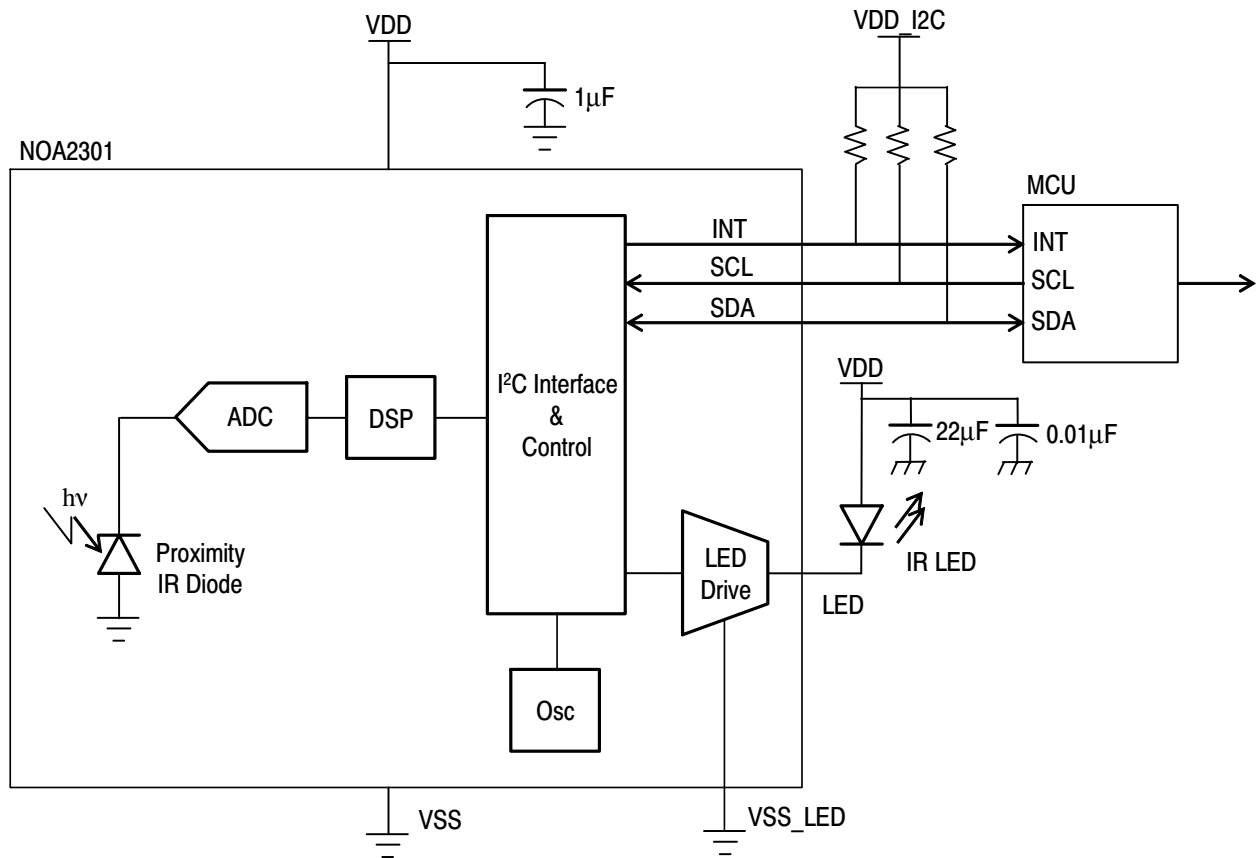

**Figure 1. NOA2301W Application Block Diagram**

**Table 1. PAD FUNCTION DESCRIPTION**

Pad	Pad Name	Description
1	VDD	Power pad
2	VSS	Ground pad
3	LED_GND	Ground pad for IR LED driver
4	LED	IR LED output pad
5	INT	Interrupt output pad, open-drain
6	SDA	Bi-directional data signal for communications with the I2C master
7	SCL	External I2C clock supplied by the I2C master

# NOA2301W

**Table 2. ABSOLUTE MAXIMUM RATINGS**

Rating	Symbol	Value	Unit
Input power supply	VDD	4.0	V
Input voltage range	V <sub>in</sub>	-0.3 to VDD + 0.2	V
Output voltage range	V <sub>out</sub>	-0.3 to VDD + 0.2	V
Maximum Junction Temperature	T <sub>J(max)</sub>	100	°C
Storage Temperature	T <sub>STG</sub>	-40 to 80	°C
ESD Capability, Human Body Model (Note 1)	ESD <sub>HBM</sub>	2	kV
ESD Capability, Charged Device Model (Note 1)	ESD <sub>CDM</sub>	500	V
Moisture Sensitivity Level	MSL	3	-
Lead Temperature Soldering (Note 2)	T <sub>SLD</sub>	260	°C

Stresses exceeding those listed in the Maximum Ratings table may damage the device. If any of these limits are exceeded, device functionality should not be assumed, damage may occur and reliability may be affected.

1. This device incorporates ESD protection and is tested by the following methods:

ESD Human Body Model tested per EIA/JESD22-A114

ESD Charged Device Model tested per ESD-STM5.3.1-1999

Latchup Current Maximum Rating:  $\bar{I}$  100 mA per JEDEC standard: JESD78

2. For information, please refer to our Soldering and Mounting Techniques Reference Manual, SOLDERRM/D

**Table 3. OPERATING RANGES**

Rating	Symbol	Min	Typ	Max	Unit
Power supply voltage	VDD	2.3		3.6	V
Power supply current, stand-by mode (VDD = 3.0 V)	IDD <sub>STBY</sub>		2.8	5	μA
Power supply average current, PS operating 300 μs integration time and 100 ms intervals	IDD <sub>PS</sub>		47	100	μA
LED average sink current, PS operating at 300 μs integration time and 100 ms intervals and LED current set at 50 mA	I <sub>LED</sub>		75		μA
I <sup>2</sup> C signal voltage (Note 3)	VDD_I2C	1.6	1.8	2.0	V
Low level input voltage (VDD_I2C related input levels)	V <sub>IL</sub>	-0.3		0.3 VDD_I2C	V
High level input voltage (VDD_I2C related input levels)	V <sub>IH</sub>	0.7 VDD_I2C		VDD_I2C + 0.2	V
Hysteresis of Schmitt trigger inputs	V <sub>hys</sub>	0.1 VDD_I2C			V
Low level output voltage (open drain) at 3 mA sink current (INT)	V <sub>OL</sub>			0.2 VDD_I2C	V
Input current of IO pin with an input voltage between 0.1 VDD and 0.9 VDD	I <sub>I</sub>	-10		10	μA
Output low current (INT)	I <sub>OL</sub>	3		-	mA
Operating free-air temperature range	T <sub>A</sub>	-40		80	°C

Functional operation above the stresses listed in the Recommended Operating Ranges is not implied. Extended exposure to stresses beyond the Recommended Operating Ranges limits may affect device reliability.

3. The I<sup>2</sup>C interface is functional to 3.0 V, but timing is only guaranteed up to 2.0 V. High Speed mode is guaranteed to be functional to 2.0 V.

## NOA2301W

**Table 4. ELECTRICAL CHARACTERISTICS** (Unless otherwise specified, these specifications apply over 2.3 V < VDD < 3.6 V, 1.7 V < VDD\_I2C < 1.9 V, -40°C < T<sub>A</sub> < 80°C, 10 pF < C<sub>b</sub> < 100 pF) (See Note 4)

Parameter	Symbol	Min	Typ	Max	Unit
LED pulse current	I <sub>LED_pulse</sub>	10		160	mA
LED pulse current step size	I <sub>LED_pulse_step</sub>		5		mA
LED pulse current accuracy	I <sub>LED_acc</sub>	-20		+20	%
Interval Timer Tolerance	Tol <sub>f_timer</sub>	-35		+35	%
Edge Triggered Interrupt Pulse Width	PW <sub>INT</sub>		50		μS
SCL clock frequency	f <sub>SCL_std</sub>	10		100	kHz
	f <sub>SCL_fast</sub>	100		400	
	f <sub>SCL_hs</sub>	100		3400	
Hold time for START condition. After this period, the first clock pulse is generated.	T <sub>HD;STA_std</sub>	4.0		-	μS
	t <sub>HD;STA_fast</sub>	0.6		-	
	t <sub>HD;STA_hs</sub>	0.160		-	
Low period of SCL clock	t <sub>LOW_std</sub>	4.7		-	μS
	t <sub>LOW_fast</sub>	1.3		-	
	t <sub>LOW_hs</sub>	0.160		-	
High period of SCL clock	t <sub>HIGH_std</sub>	4.0		-	μS
	t <sub>HIGH_fast</sub>	0.6		-	
	t <sub>HIGH_hs</sub>	0.060		-	
SDA Data hold time	t <sub>HD;DAT_d_std</sub>	0		3.45	μS
	t <sub>HD;DAT_d_fast</sub>	0		0.9	
	t <sub>HD;DAT_d_hs</sub>	0		0.070	
SDA Data set-up time	t <sub>SU;DAT_std</sub>	250		-	nS
	t <sub>SU;DAT_fast</sub>	100		-	
	t <sub>SU;DAT_hs</sub>	10		-	
Rise time of both SDA and SCL (input signals) (Note 5)	t <sub>r_INPUT_std</sub>	20		1000	nS
	t <sub>r_INPUT_fast</sub>	20		300	
	t <sub>r_INPUT_hs</sub>	10		40	
Fall time of both SDA and SCL (input signals) (Note 5)	t <sub>f_INPUT_std</sub>	20		300	nS
	t <sub>f_INPUT_fast</sub>	20		300	
	t <sub>f_INPUT_hs</sub>	10		40	
Rise time of SDA output signal (Note 5)	t <sub>r_OUT_std</sub>	20		300	nS
	t <sub>r_OUT_fast</sub>	20 + 0.1 C <sub>b</sub>		300	
	t <sub>r_OUT_hs</sub>	10		80	
Fall time of SDA output signal (Note 5)	t <sub>f_OUT_std</sub>	20		300	nS
	t <sub>f_OUT_fast</sub>	20 + 0.1 C <sub>b</sub>		300	
	t <sub>f_OUT_hs</sub>	10		80	
Set-up time for STOP condition	t <sub>SU;STO_std</sub>	4.0		-	μS
	t <sub>SU;STO_fast</sub>	0.6		-	
	t <sub>SU;STO_hs</sub>	0.160		-	

4. Refer to Figure 2 and Figure 3 for more information on AC characteristics.

5. The rise time and fall time are dependent on both the bus capacitance (C<sub>b</sub>) and the bus pull-up resistor R<sub>p</sub>. Max and min pull-up resistor values are determined as follows: R<sub>p(max)</sub> = t<sub>r(max)</sub> / (0.8473 × C<sub>b</sub>) and R<sub>p(min)</sub> = (V<sub>dd\_I2C</sub> - V<sub>ol(max)</sub>) / I<sub>ol</sub>.

6. C<sub>b</sub> = capacitance of one bus line, maximum value of which including all parasitic capacitances should be less than 100 pF. Bus capacitance up to 400 pF is supported, but at relaxed timing.

## NOA2301W

**Table 4. ELECTRICAL CHARACTERISTICS** (Unless otherwise specified, these specifications apply over 2.3 V < VDD < 3.6 V, 1.7 V < VDD\_I2C < 1.9 V, -40°C < T<sub>A</sub> < 80°C, 10 pF < C<sub>b</sub> < 100 pF) (See Note 4)

Parameter	Symbol	Min	Typ	Max	Unit
Bus free time between STOP and START condition	t <sub>BUF_std</sub>	4.7		–	μS
	t <sub>BUF_fast</sub>	1.3		–	
	t <sub>BUF_hs</sub>	0.160		–	
Capacitive load for each bus line (including all parasitic capacitance) (Note 6)	C <sub>b</sub>	10		100	pF
Noise margin at the low level (for each connected device – including hysteresis)	V <sub>nL</sub>	0.1 VDD		–	V
Noise margin at the high level (for each connected device – including hysteresis)	V <sub>nH</sub>	0.2 VDD		–	V

4. Refer to Figure 2 and Figure 3 for more information on AC characteristics.
5. The rise time and fall time are dependent on both the bus capacitance (C<sub>b</sub>) and the bus pull-up resistor R<sub>p</sub>. Max and min pull-up resistor values are determined as follows: R<sub>p(max)</sub> = t<sub>r(max)</sub> / (0.8473 × C<sub>b</sub>) and R<sub>p(min)</sub> = (V<sub>dd\_I2C</sub> – V<sub>ol(max)</sub>) / I<sub>ol</sub>.
6. C<sub>b</sub> = capacitance of one bus line, maximum value of which including all parasitic capacitances should be less than 100 pF. Bus capacitance up to 400 pF is supported, but at relaxed timing.

Product parametric performance is indicated in the Electrical Characteristics for the listed test conditions, unless otherwise noted. Product performance may not be indicated by the Electrical Characteristics if operated under different conditions.

**Table 5. OPTICAL CHARACTERISTICS** (Unless otherwise specified, these specifications are for VDD = 3.0 V, T<sub>A</sub> = 25°C)(Note 7)

Parameter	Symbol	Min	Typ	Max	Unit
Detection range, T <sub>int</sub> = 4800 μs, I <sub>LED</sub> = 160 mA, 860 nm IR LED (OS-RAM SFH4650), White Reflector (RGB = 220, 224, 223), LED Modulation Frequency = 308 kHz, Sample Delay = 250 ns, SNR = 7:1	D <sub>PS_4800_WHITE_MOD</sub>		200		mm
Detection range, T <sub>int</sub> = 4800 μs, I <sub>LED</sub> = 160 mA, 860 nm IR LED (OS-RAM SFH4650), White Reflector (RGB = 220, 224, 223), SNR = 8:1	D <sub>PS_4800_WHITE_160</sub>		148		mm
Detection range, T <sub>int</sub> = 4800 μs, I <sub>LED</sub> = 25 mA, 860 nm IR LED (OS-RAM SFH4650), White Reflector (RGB = 220, 224, 223), SNR = 8:1	D <sub>PS_4800_WHITE_25</sub>		66		mm
Detection range, T <sub>int</sub> = 2400 μs, I <sub>LED</sub> = 50 mA, 860 nm IR LED (OS-RAM SFH4650), White Reflector (RGB = 220, 224, 223), SNR = 8:1	D <sub>PS_2400_WHITE_25</sub>		80		mm
Detection range, T <sub>int</sub> = 1800 μs, I <sub>LED</sub> = 75 mA, 860 nm IR LED (OS-RAM SFH4650), White Reflector (RGB = 220, 224, 223), SNR = 8:1	D <sub>PS_1800_WHITE_75</sub>		88		mm
Detection range, T <sub>int</sub> = 1200 μs, I <sub>LED</sub> = 100 mA, 860 nm IR LED (OS-RAM SFH4650), White Reflector (RGB = 220, 224, 223), SNR = 8:1	D <sub>PS_1200_WHITE_100</sub>		90		mm
Detection range, T <sub>int</sub> = 600 μs, I <sub>LED</sub> = 125 mA, 860 nm IR LED (OS-RAM SFH4650), White Reflector (RGB = 220, 224, 223), SNR = 8:1	D <sub>PS_600_WHITE_125</sub>		88		mm
Detection range, T <sub>int</sub> = 600 μs, I <sub>LED</sub> = 100 mA, 860 nm IR LED (OS-RAM SFH4650), White Reflector (RGB = 220, 224, 223), SNR = 8:1	D <sub>PS_600_WHITE_100</sub>		76		mm
Detection range, T <sub>int</sub> = 300 μs, I <sub>LED</sub> = 150 mA, 860 nm IR LED (OS-RAM SFH4650), White Reflector (RGB = 220, 224, 223), SNR = 8:1	D <sub>PS_300_WHITE_150</sub>		74		mm
Detection range, T <sub>int</sub> = 300 μs, I <sub>LED</sub> = 100 mA, 860 nm IR LED (OS-RAM SFH4650), White Reflector (RGB = 220, 224, 223), SNR = 8:1	D <sub>PS_300_WHITE_100</sub>		62		mm
Detection range, T <sub>int</sub> = 150 μs, I <sub>LED</sub> = 100 mA, 860 nm IR LED (OS-RAM SFH4650), White Reflector (RGB = 220, 224, 223), SNR = 8:1	D <sub>PS_150_WHITE_100</sub>		48		mm
Detection range, T <sub>int</sub> = 1200 μs, I <sub>LED</sub> = 100 mA, 860 nm IR LED (OS-RAM SFH4650), Grey Reflector (RGB = 162, 162, 160), SNR = 6:1	D <sub>PS_1200_GREY_100</sub>		64		mm
Detection range, T <sub>int</sub> = 2400 μs, I <sub>LED</sub> = 150 mA, 860 nm IR LED (OS-RAM SFH4650), Black Reflector (RGB = 16, 16, 15), SNR = 6:1	D <sub>PS_2400_BLACK_150</sub>		36		mm
Saturation power level	P <sub>DMAX</sub>		0.8		mW/cm <sup>2</sup>
Measurement resolution, T <sub>int</sub> = 150 μs	MR <sub>150</sub>		11		bits

7. Measurements performed with default modulation frequency and sample delay unless noted.

# NOA2301W

**Table 5. OPTICAL CHARACTERISTICS** (Unless otherwise specified, these specifications are for VDD = 3.0 V, T<sub>A</sub> = 25°C)(Note 7)

Parameter	Symbol	Min	Typ	Max	Unit
Measurement resolution, T <sub>int</sub> = 300 μs	MR <sub>300</sub>		12		bits
Measurement resolution, T <sub>int</sub> = 600 μs	MR <sub>600</sub>		13		bits
Measurement resolution, T <sub>int</sub> = 1200 μs	MR <sub>1200</sub>		14		bits
Measurement resolution, T <sub>int</sub> = 1800 μs	MR <sub>1800</sub>		15		bits
Measurement resolution, T <sub>int</sub> = 2400 μs	MR <sub>2400</sub>		15		bits
Measurement resolution, T <sub>int</sub> = 3600 μs	MR <sub>3600</sub>		16		bits
Measurement resolution, T <sub>int</sub> = 4800 μs	MR <sub>4800</sub>		16		bits

7. Measurements performed with default modulation frequency and sample delay unless noted.

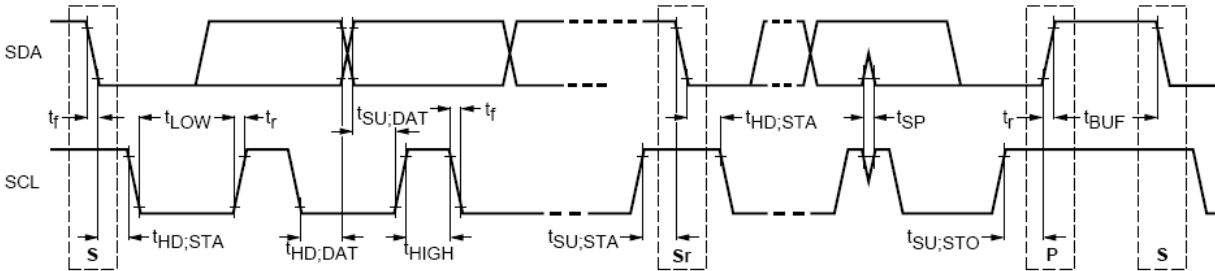

**Figure 2. AC Characteristics, Standard and Fast Modes**

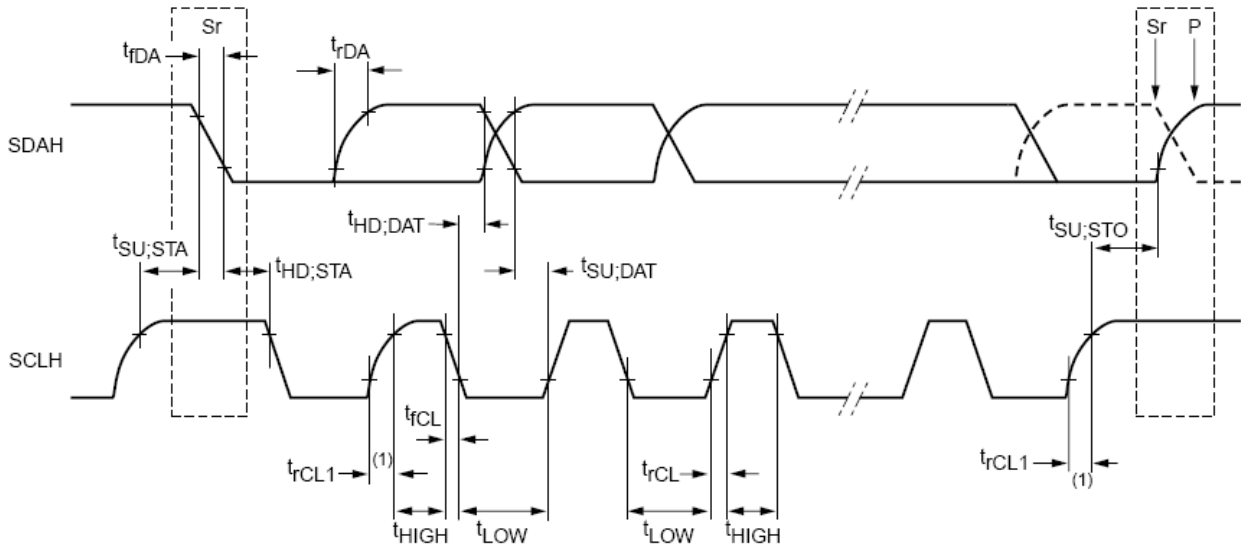

**Figure 3. AC Characteristics, High Speed Mode**

TYPICAL CHARACTERISTICS

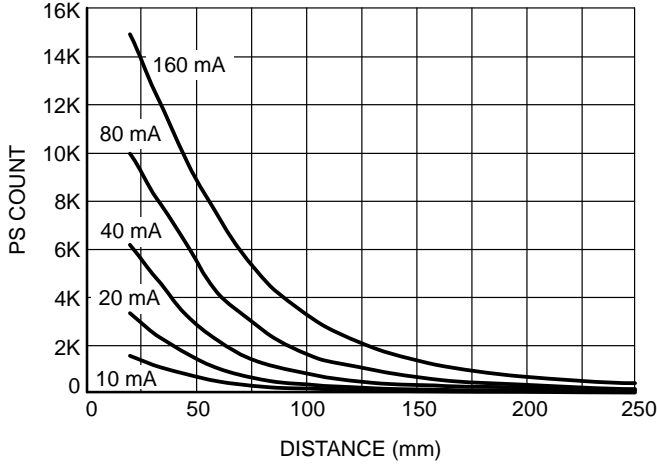

Figure 4. PS Response vs. Distance and LED Current (1200  $\mu$ s Integration Time, White Reflector (RGB = 220, 224, 223))

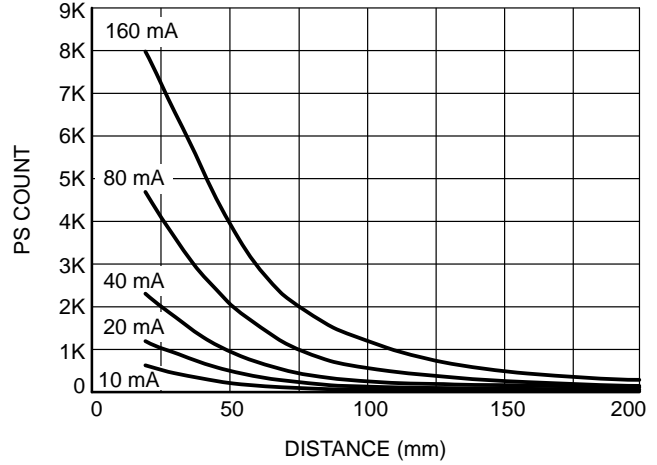

Figure 5. PS Response vs. Distance and LED Current (1200  $\mu$ s Integration Time, Grey Reflector (RGB = 162, 162, 160))

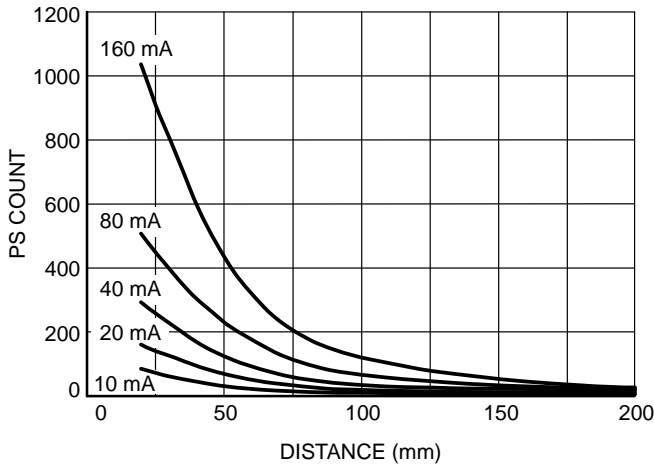

Figure 6. PS Response vs. Distance and LED Current (1200  $\mu$ s Integration Time, Black Reflector (RGB = 16, 16, 15))

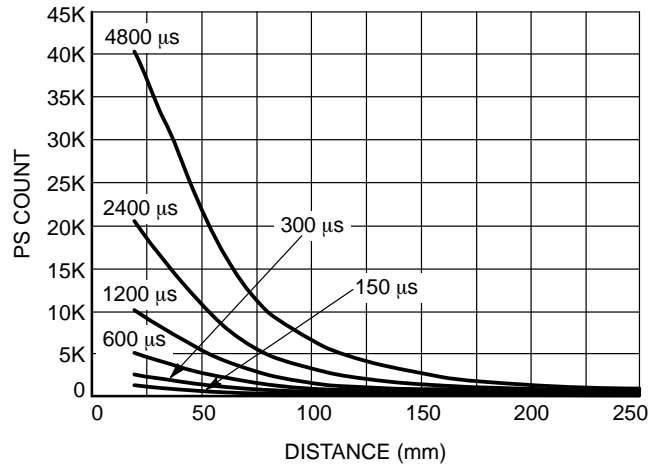

Figure 7. PS Response vs. Distance and Integration Time (80 mA LED Current, White Reflector (RGB = 220, 224, 223))

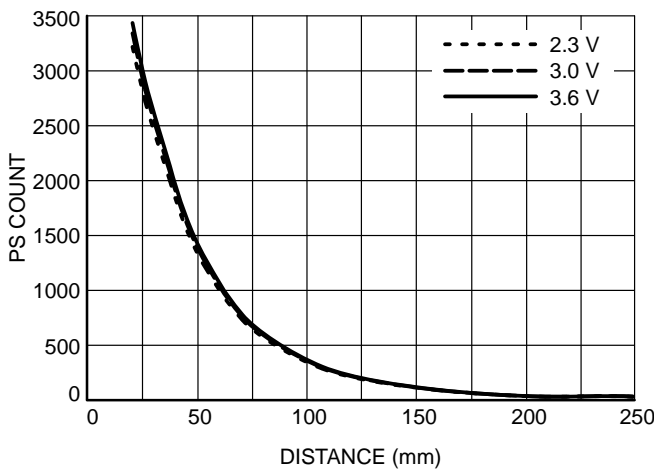

Figure 8. PS Response vs. Distance and Supply Voltage (1200  $\mu$ s Integration Time, 40 mA LED Current, White Reflector (RGB = 220, 224, 223))

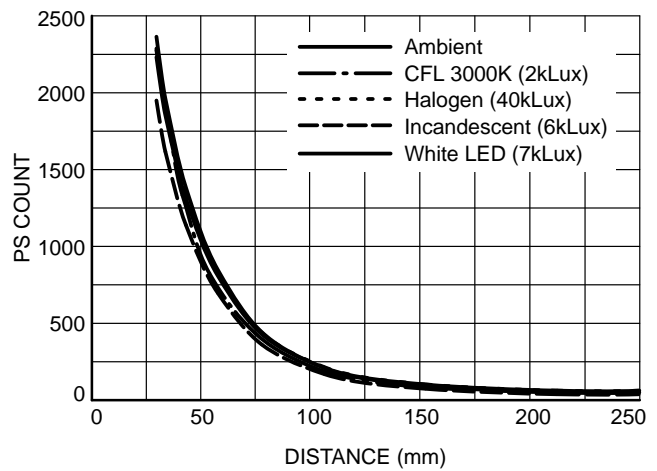

Figure 9. PS Ambient Rejection (1200  $\mu$ s Integration Time, 100 mA LED Current, White Reflector (RGB = 220, 224, 223))

# NOA2301W

## TYPICAL CHARACTERISTICS

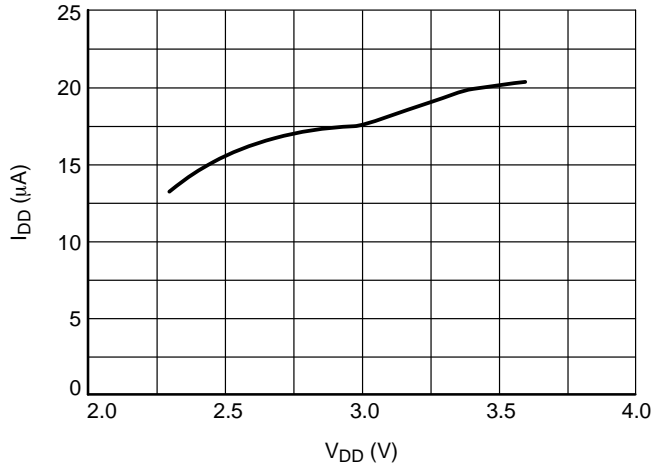

Figure 10. Supply Current vs. Supply Voltage  
 $T_{INT} = 300 \mu\text{s}$ ,  $T_R = 100 \text{ms}$

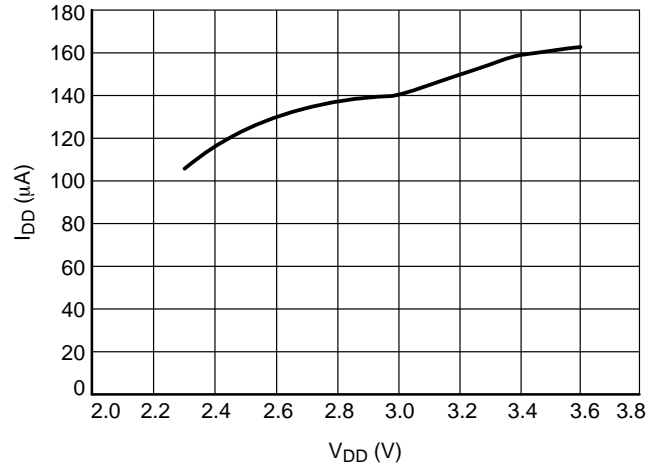

Figure 11. Supply Current vs. Supply Voltage  
 $T_{INT} = 1200 \mu\text{s}$ ,  $T_R = 50 \text{ms}$



Description of Operation

Proximity Sensor Architecture

NOA2301W combines an advanced digital proximity sensor, LED driver and a tri-mode I<sup>2</sup>C interface as shown in Figure 1. The LED driver draws a modulated current through the external IR LED to illuminate the target. The LED current is programmable over a wide range. The infrared light reflected from the target is detected by the proximity sensor photo diode. The proximity sensor employs a sensitive photo diode fabricated in ON Semiconductor’s standard CMOS process technology. The modulated light received by the on-chip photodiode is converted to a digital signal using a variable slope integrating ADC with a default resolution (at 300 μs) of 12-bits, unsigned. The signal is processed to remove all unwanted signals resulting in a highly selective response to the generated light signal. The final value is stored in the PS\_DATA register where it can be read by the I<sup>2</sup>C interface.

Proximity Sensor LED Frequency and Delay Settings

The LED current modulation frequency is user selectable from approximately 128 KHz to 2 MHz using the PS\_LED\_FREQUENCY register. An internal precision 4 MHz oscillator provides the frequency reference. The 4 MHz clock is divided by the value in register 0x0D to determine the pulse rate. The default is 0x10 (16) which results in an LED pulse frequency of 250 KHz (4 μs period). Values below 200 KHz and above 1 MHz are not recommended.

Switching high LED currents can result in noise injected into the proximity sensor receiver causing inaccurate readings. The PS receiver has a user programmable delay from the LED edge to when the receiver samples the data (PS\_SAMPLE\_DELAY – register 0x0E). Longer delays may reduce the effect of switching noise but also reduce the sensitivity.

Since the value of the delay is dependent on the pulse frequency, its value must be carefully computed. The value

obviously cannot exceed the LED pulse width or there would be no sampling of the data when the LED is illuminated. There is also a minimum step size of 125 ns.

The delay values are programmed as follows:

- 0 or 1: No delay
- 2–31: Selects (N–1)\*125 ns
- N must be less than or equal to the PS\_LED\_FREQUENCY Value
- The default delay is 0x05 (500 ns)

Table 6 shows some common LED pulse frequencies and sample delays and the resulting register values.

Table 6. COMMON LED PULSE FREQUENCY SETTINGS

LED Pulse Frequency (KHz)	Sample Delay (ns)	PS_LED_FREQUENCY Register (0x0D) Value	PS_SAMPLE_DELAY Register (0x0E) Value
200	250	0x14	0x03
200	500	0x14	0x05
200	750	0x14	0x07
250	250	0x10	0x03
250	500	0x10	0x05
500	250	0x08	0x03
500	500	0x08	0x05
1000	250	0x04	0x03

I<sup>2</sup>C Interface

The NOA2301W acts as an I<sup>2</sup>C slave device and supports single register and block register read and write operations. All data transactions on the bus are 8 bits long. Each data byte transmitted is followed by an acknowledge bit. Data is transmitted with the MSB first.

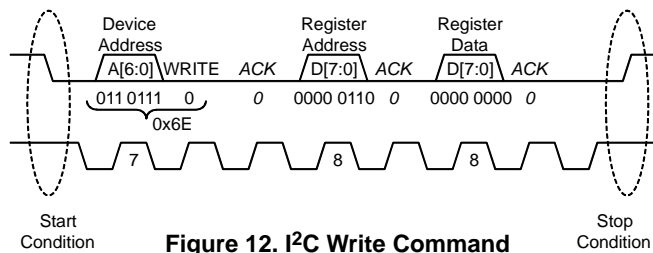

Figure 12. I<sup>2</sup>C Write Command

Figure 12 shows an I<sup>2</sup>C write operation. Write transactions begin with the master sending an I<sup>2</sup>C start sequence followed by the seven bit slave address (NOA2301W = 0x37) and the write(0) command bit. The NOA2301W will acknowledge this byte transfer with an appropriate ACK. Next the master will send the 8 bit register address to be written to. Again the NOA2301W will acknowledge reception with an ACK. Finally, the master will begin sending 8 bit data segment(s) to be written to the

NOA2301W register bank. The NOA2301W will send an ACK after each byte and increment the address pointer by one in preparation for the next transfer. Write transactions are terminated with either an I<sup>2</sup>C STOP or with another I<sup>2</sup>C START (repeated START).

Figure 13 shows an I<sup>2</sup>C read command sent by the master to the slave device. Read transactions begin in much the same manner as the write transactions in that the slave address must be sent with a write(0) command bit.

## NOA2301W

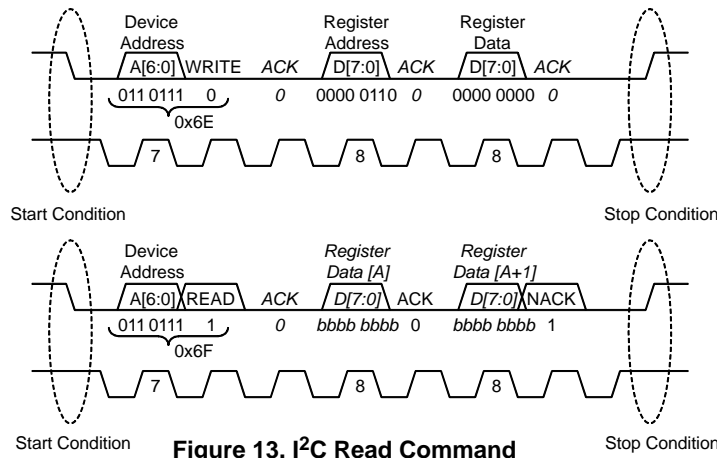

**Figure 13. I<sup>2</sup>C Read Command**

After the NOA2301W sends an ACK, the master sends the register address as if it were going to be written to. The NOA2301W will acknowledge this as well. Next, instead of sending data as in a write, the master will re-issue an I<sup>2</sup>C START (repeated start) and again send the slave address and this time the read(1) command bit. The NOA2301W will then begin shifting out data from the register just addressed. If the master wishes to receive more data (next register address), it will ACK the slave at the end of the 8 bit data transmission, and the slave will respond by sending the next byte, and so on. To signal the end of the read transaction, the master will send a NACK bit at the end of a transmission followed by an I<sup>2</sup>C STOP.

The NOA2301W also supports I<sup>2</sup>C high-speed mode. The transition from standard or fast mode to high-speed mode is initiated by the I<sup>2</sup>C master. A special reserve device address is called for and any device that recognizes this and supports high speed mode immediately changes the

performance characteristics of its I/O cells in preparation for I<sup>2</sup>C transactions at the I<sup>2</sup>C high speed data protocol rates. From then on, standard I<sup>2</sup>C commands may be issued by the master, including repeated START commands. When the I<sup>2</sup>C master terminates any I<sup>2</sup>C transaction with a STOP sequence, the master and all slave devices immediately revert back to standard/fast mode I/O performance.

By using a combination of high-speed mode and a block write operation, it is possible to quickly initialize the NOA2301W I<sup>2</sup>C register bank.

### NOA2301W Data Registers

NOA2301W operation is observed and controlled by internal data registers read from and written to via the external I<sup>2</sup>C interface. Registers are listed in Table 7. Default values are set on initial power up or via a software reset command (register 0x01).

The I<sup>2</sup>C Slave Address of the NOA2301W is 0x37.

**Table 7. NOA2301W DATA REGISTERS**

Address	Type	Name	Description
0x00	R	PART_ID	NOA2301W part number and revision IDs
0x01	RW	RESET	Software reset control
0x02	RW	INT_CONFIG	Interrupt pin functional control settings
0x0D	RW	PS_LED_FREQUENCY	PS LED Pulse Frequency
0x0E	RW	PS_SAMPLE_DELAY	PS Sample Delay
0x0F	RW	PS_LED_CURRENT	PS LED pulse current
0x10	RW	PS_TH_UP_MSB	PS Interrupt upper threshold, most significant bits
0x11	RW	PS_TH_UP_LSB	PS Interrupt upper threshold, least significant bits
0x12	RW	PS_TH_LO_MSB	PS Interrupt lower threshold, most significant bits
0x13	RW	PS_TH_LO_LSB	PS Interrupt lower threshold, least significant bits
0x14	RW	PS_FILTER_CONFIG	PS Interrupt Filter configuration
0x15	RW	PS_CONFIG	PS Integration time configuration
0x16	RW	PS_INTERVAL	PS Interval time configuration
0x17	RW	PS_CONTROL	PS Operation mode control
0x40	R	INTERRUPT	Interrupt status
0x41	R	PS_DATA_MSB	PS measurement data, most significant bits
0x42	R	PS_DATA_LSB	PS measurement data, least significant bits

# NOA2301W

## PART\_ID Register (0x00)

The PART\_ID register provides part and revision identification. These values are hard-wired at the factory and cannot be modified.

**Table 8. PART\_ID Register (0x00)**

<b>Bit</b>	<b>7</b>	<b>6</b>	<b>5</b>	<b>4</b>	<b>3</b>	<b>2</b>	<b>1</b>	<b>0</b>
<b>Field</b>	Part number ID				Revision ID			

Field	Bit	Default	Description
Part number ID	7:4	0101	Part number identification
Revision ID	3:0	NA	Silicon revision number

## RESET Register (0x01)

Software reset is controlled by this register. Setting this register followed by an I2C\_STOP sequence will immediately reset the NOA2301W to the default startup

standby state. Triggering the software reset has virtually the same effect as cycling the power supply tripping the internal Power on Reset (POR) circuitry.

**Table 9. RESET Register (0x01)**

<b>Bit</b>	<b>7</b>	<b>6</b>	<b>5</b>	<b>4</b>	<b>3</b>	<b>2</b>	<b>1</b>	<b>0</b>
<b>Field</b>	NA							SW_reset

Field	Bit	Default	Description
NA	7:1	XXXXXXX	Don't care
SW_reset	0	0	Software reset to startup state

## INT\_CONFIG Register (0x02)

INT\_CONFIG register controls the external interrupt pin function.

**Table 10. INT\_CONFIG Register (0x02)**

<b>Bit</b>	<b>7</b>	<b>6</b>	<b>5</b>	<b>4</b>	<b>3</b>	<b>2</b>	<b>1</b>	<b>0</b>
<b>Field</b>	NA				edge_triggered		auto_clear	polarity

Field	Bit	Default	Description	
NA	7:3	XXXXX	Don't care	
Edge_triggered	2	0	0	Interrupt pin stays asserted while the INTERRUPT register bit is set (level)
			1	Interrupt pin pulses at the end of each measurement while the INTERRUPT register bit is set
auto_clear	1	1	0	When an interrupt is triggered, the interrupt pin remains asserted until cleared by an I <sup>2</sup> C read of INTERRUPT register
			1	Interrupt pin state is updated after each measurement
polarity	0	0	0	Interrupt pin active low when asserted
			1	Interrupt pin active high when asserted

## NOA2301W

### PS\_LED\_FREQUENCY Register (0x0D)

The LED FREQUENCY register controls the frequency of the LED pulses. The LED modulation frequency is determined by dividing 4 MHz by the register value. Valid

divisors are 2–31. The default value is 16 which results in an LED pulse frequency of 250 KHz (one pulse every 4  $\mu$ s).

**Table 11. PS\_LED\_FREQUENCY Register (0x0D)**

Bit	7	6	5	4	3	2	1	0
Field	NA			LED_modulation frequency				

Field	Bit	Default	Description
NA	7:5	XXX	Don't care
LED_modulation_frequency	4:0	10000	Defines the divider of the 4MHz clock to generate the LED pulses. Valid values are 2–31

### PS\_SAMPLE\_DELAY Register (0x0E)

The PS\_SAMPLE\_DELAY register controls the time delay after an LED pulse edge before the resulting signal is sampled by the proximity sensor. This can be used to reduce the effect of noise caused by the LED current switching. There is no delay for programmed values of 0x00 or 0x001. For other values the delay is  $(N-1)*125$  ns, where N is the

decimal value of the register. Default value is 0x05 (500 ns). N must be less than or equal to the value in register 0x0D (PS\_LED\_FREQUENCY). See the Description of Operation section for more information on programming this register.

**Table 12. PS\_SAMPLE\_DELAY Register (0x0E)**

Bit	7	6	5	4	3	2	1	0
Field	NA			sample_delay				

Field	Bit	Default	Description
NA	7:5	XXX	Don't care
sample_delay	4:0	00101	Defines the delay from the LED pulse edge before the pulse is sampled

### PS\_LED\_CURRENT Register (0x0F)

The LED\_CURRENT register controls how much current the internal LED driver sinks through the IR LED during modulated illumination. The current sink range is 5 mA plus a binary weighted value of the LED\_Current register times

5 mA, for an effective range of 10 mA to 160 mA in steps of 5 mA. The default setting is 50 mA. A register setting of 00 turns off the LED Driver.

**Table 13. PS\_LED\_CURRENT Register (0x0F)**

Bit	7	6	5	4	3	2	1	0
Field	NA			LED_Current				

Field	Bit	Default	Description
NA	7:5	XXX	Don't care
LED_Current	4:0	01001	Defines current sink during LED modulation. Binary weighted value times 5 mA plus 5 mA

**PS\_TH Registers (0x10 – 0x13)**

With hysteresis not enabled (see PS\_CONFIG register), the PS\_TH registers set the upper and lower interrupt thresholds of the proximity detection window. Interrupt functions compare these threshold values to data from the PS\_DATA registers. Measured PS\_DATA values outside this window will set an interrupt according to the INT\_CONFIG register settings.

With hysteresis enabled, threshold settings take on a different meaning. If PS\_hyst\_trig is set, the PS\_TH\_UP register sets the upper threshold at which an interrupt will be set, while the PS\_TH\_LO register then sets the lower

threshold hysteresis value where the interrupt would be cleared. Setting the PS\_hyst\_trig low reverses the function such that the PS\_TH\_LO register sets the lower threshold at which an interrupt will be set and the PS\_TH\_UP represents the hysteresis value at which the interrupt would be subsequently cleared. Hysteresis functions only apply in “auto\_clear” INT\_CONFIG mode.

The controller software must ensure the settings for LED current, sensitivity range, and integration time (LED pulses) are appropriate for selected thresholds. Setting thresholds to extremes (default) effectively disables interrupts.

**Table 14. PS\_TH\_UP Registers (0x10 – 0x11)**

Bit	7	6	5	4	3	2	1	0
Field	PS_TH_UP_MSB(0x10), PS_TH_UP_LSB(0x11)							

Field	Bit	Default	Description
PS_TH_UP_MSB	7:0	0xFF	Upper threshold for proximity detection, MSB
PS_TH_UP_LSB	7:0	0xFF	Upper threshold for proximity detection, LSB

**Table 15. PS\_TH\_LO Registers (0x12 – 0x13)**

Bit	7	6	5	4	3	2	1	0
Field	PS_TH_LO_MSB(0x12), PS_TH_LO_LSB(0x13)							

Field	Bit	Default	Description
PS_TH_LO_MSB	7:0	0x00	Lower threshold for proximity detection, MSB
PS_TH_LO_LSB	7:0	0x00	Lower threshold for proximity detection, LSB

**PS\_FILTER\_CONFIG Register (0x14)**

PS\_FILTER\_CONFIG register provides a hardware mechanism to filter out single event occurrences or similar anomalies from causing unwanted interrupts. Two 4 bit registers (M and N) can be set with values such that M out of N measurements must exceed threshold settings in order

to set an interrupt. The default setting of 1 out of 1 effectively turns the filter off and any single measurement exceeding thresholds can trigger an interrupt. N must be greater than or equal to M. A setting of 0 for either M or N is not allowed and disables the PS interrupt.

**Table 16. PS\_FILTER\_CONFIG Register (0x14)**

Bit	7	6	5	4	3	2	1	0
Field	filter_N				filter_M			

Field	Bit	Default	Description
filter_N	7:4	0001	Filter N
filter_M	3:0	0001	Filter M

## NOA2301W

### PS\_CONFIG Register (0x15)

Proximity measurement sensitivity is controlled by specifying the integration time. The integration time sets the number of LED pulses during the modulated illumination. The LED modulation frequency remains constant with a period of 1.5  $\mu$ s. Changing the integration time affects the sensitivity of the detector and directly affects the power

consumed by the LED. The default is 1200  $\mu$ s integration period.

Hyst\_enable and hyst\_trigger work with the PS\_TH (threshold) settings to provide jitter control of the INT function.

**Table 17. PS\_CONFIG Register (0x15)**

Bit	7	6	5	4	3	2	1	0
Field	NA		hyst_enable	hyst_trigger	NA		integration_time	

Field	Bit	Default	Description	
NA	7:6	XX	Don't Care	
hyst_enable	5	0	0	Disables hysteresis
			1	Enables hysteresis
hyst_trigger	4	0	0	Lower threshold with hysteresis
			1	Upper threshold with hysteresis
NA	3	X	Don't care	
integration_time	2:0	011	000	150 $\mu$ s integration time
			001	300 $\mu$ s integration time
			010	600 $\mu$ s integration time
			011	1200 $\mu$ s integration time
			100	1800 $\mu$ s integration time
			101	2400 $\mu$ s integration time
			110	3600 $\mu$ s integration time
			111	4800 $\mu$ s integration time

### PS\_INTERVAL Register (0x16)

The PS\_INTERVAL register sets the wait time between consecutive proximity measurements in PS\_Repeat mode. The register is binary weighted times 10 in milliseconds plus

10 ms. The range is therefore 10 ms to 1.28 s. The default startup value is 0x04 (50 ms).

**Table 18. PS\_INTERVAL Register (0x16)**

Bit	7	6	5	4	3	2	1	0
Field	NA	interval						

Field	Bit	Default	Description	
NA	7	X	Don't care	
Interval	6:0	0x04	0x00 to 0x7F	Interval time between measurement cycles. Binary weighted value times 10 ms plus a 10 ms offset.

## NOA2301W

### PS\_CONTROL Register (0x17)

The PS\_CONTROL register is used to control the functional mode and commencement of proximity sensor measurements. The proximity sensor can be operated in either a single shot mode or consecutive measurements taken at programmable intervals.

Both single shot and repeat modes consume a minimum of power by immediately turning off LED driver and sensor circuitry after each measurement. In both cases the quiescent current is less than the  $IDD_{STBY}$  parameter. These automatic power management features eliminate the need for power down pins or special power down instructions.

**Table 19. PS\_CONTROL Register (0x17)**

Bit	7	6	5	4	3	2	1	0
Field	NA						PS_Repeat	PS_OneShot

Field	Bit	Default	Description
NA	7:2	XXXXXX	Don't care
PS_Repeat	1	0	Initiates new measurements at PS_Interval rates
PS_OneShot	0	0	Triggers proximity sensing measurement. In single shot mode this bit clears itself after cycle completion.

### INTERRUPT Register (0x40)

The INTERRUPT register displays the status of the interrupt pin. If “auto\_clear” is disabled (see INT\_CONFIG register), reading this register also will clear the interrupt.

**Table 20. INTERRUPT Register (0x40)**

Bit	7	6	5	4	3	2	1	0
Field	NA			INT			PS_intH	PS_intL

Field	Bit	Default	Description
NA	7:5	XXX	Don't care
INT	4	0	Status of external interrupt pin (1 is asserted)
NA	3:2	XX	Don't care
PS_intH	1	0	Interrupt caused by PS exceeding maximum
PS_intL	0	0	Interrupt caused by PS falling below the minimum

### PS\_DATA Registers (0x41 – 0x42)

The PS\_DATA registers store results from completed proximity measurements. When an I<sup>2</sup>C read operation begins, the current PS\_DATA registers are locked until the

operation is complete (I2C\_STOP received) to prevent possible data corruption from a concurrent measurement cycle.

**Table 21. PS\_DATA Registers (0x41 – 0x42)**

Bit	7	6	5	4	3	2	1	0
Field	PS_DATA_MSB(0x41), PS_DATA_LSB(0x42)							

Field	Bit	Default	Description
PS_DATA_MSB	7:0	0x00	Proximity measurement data, MSB
PS_DATA_LSB	7:0	0x00	Proximity measurement data, LSB

**Proximity Sensor Operation**

NOA2301W operation is divided into three phases: power up, configuration and operation. On power up the device initiates a reset which initializes the configuration registers to their default values and puts the device in the standby state. At any time, the host system may initiate a software reset by writing 0x01 to register 0x01. A software reset performs the same function as a power-on-reset.

The configuration phase may be skipped if the default register values are acceptable, but typically it is desirable to change some or all of the configuration register values. Configuration is accomplished by writing the desired configuration values to registers 0x02 through 0x17. Writing to configuration registers can be done with either individual I<sup>2</sup>C byte-write commands or with one or more I<sup>2</sup>C block write commands. Block write commands specify the first register address and then write multiple bytes of data in sequence. The NOA2301W automatically increments the register address as it acknowledges each byte transfer.

Proximity sensor measurement is initiated by writing appropriate values to the CONTROL register (0x17).

Sending an I2C\_STOP sequence at the end of the write signals the internal state machines to wake up and begin the next measurement cycle. Figure 14 and Figure 15 illustrate the activity of key signals during a proximity sensor measurement cycle. The cycle begins by starting the precision oscillator and powering up the proximity sensor receiver. Next, the IR LED current is modulated according to the LED current setting at the chosen LED frequency and the values during both the on and off times of the LED are stored (illuminated and ambient values). Finally, the proximity reading is calculated by subtracting the ambient value from the illuminated value and storing the result in the 16 bit PS\_Data register. In One-shot mode, the PS receiver is then powered down and the oscillator is stopped. If Repeat mode is set, the PS receiver is powered down for the specified interval and the process is repeated. With default configuration values (receiver integration time = 1200 μs), the total measurement cycle will be less than 2 ms.

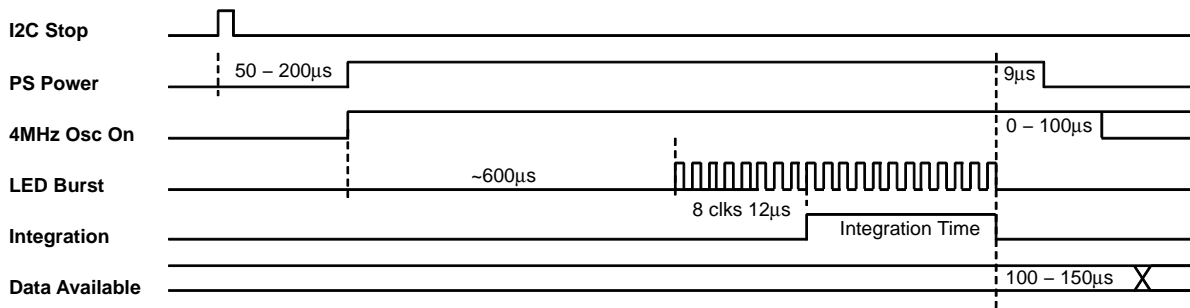

Figure 14. Proximity Sensor One-Shot Timing

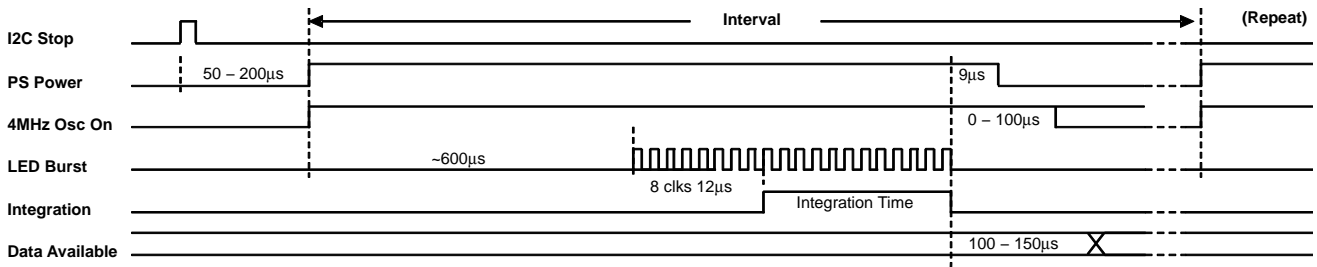

Figure 15. Proximity Sensor Repeat Timing



# NOA2301W

## Example Programming Sequence

The following pseudo code configures the NOA2301W proximity sensor in repeat mode with 50 ms wait time between each measurement and then runs it in an interrupt driven mode. When the controller receives an interrupt, the

interrupt determines if the interrupts was caused by the proximity sensor and if so, reads the PS\_Data from the device, sets a flag and then waits for the main polling loop to respond to the proximity change.

```
external subroutine I2C_Read_Byte (I2C_Address, Data_Address);
external subroutine I2C_Read_Block (I2C_Address, Data_Start_Address, Count, Memory_Map);
external subroutine I2C_Write_Byte (I2C_Address, Data_Address, Data);
external subroutine I2C_Write_Block (I2C_Address, Data_Start_Address, Count, Memory_Map);
subroutine Initialize_PS () {

    MemBuf[0x02] = 0x02;    // INT_CONFIG assert interrupt until cleared
    MemBuf[0x0F] = 0x09;    // PS_LED_CURRENT 50mA
    MemBuf[0x10] = 0x8F;    // PS_TH_UP_MSB
    MemBuf[0x11] = 0xFF;    // PS_TH_UP_LSB
    MemBuf[0x12] = 0x70;    // PS_TH_LO_MSB
    MemBuf[0x13] = 0x00;    // PS_TH_LO_LSB
    MemBuf[0x14] = 0x11;    // PS_FILTER_CONFIG turn off filtering
    MemBuf[0x15] = 0x09;    // PS_CONFIG 300us integration time
    MemBuf[0x16] = 0x0A;    // PS_INTERVAL 50ms wait
    MemBuf[0x17] = 0x02;    // PS_CONTROL enable continuous PS measurements

    I2C_Write_Block (I2CAddr, 0x02, 37, MemBuf);
}

subroutine I2C_Interupt_Handler () {
    // Verify this is a PS interrupt
    INT = I2C_Read_Byte (I2CAddr, 0x40);
    if (INT == 0x11 || INT == 0x12) {
        // Retrieve and store the PS data
        PS_Data_MSB = I2C_Read_Byte (I2CAddr, 0x41);
        PS_Data_LSB = I2C_Read_Byte (I2CAddr, 0x42);
        NewPS = 0x01;
    }
}

subroutine main_loop () {
    I2CAddr = 0x37;
    NewPS = 0x00;
    Initialize_PS ();
    loop {
        // Do some other polling operations
        if (NewPS == 0x01) {
            NewPS = 0x00;
            // Do some operations with PS_Data
        }
    }
}
```

# NOA2301W

## Physical Location of Photodiode Sensor

The physical locations of the NOA2301W proximity sensor photodiode is shown in Figure 16 referenced to the lower left hand corner of the die.

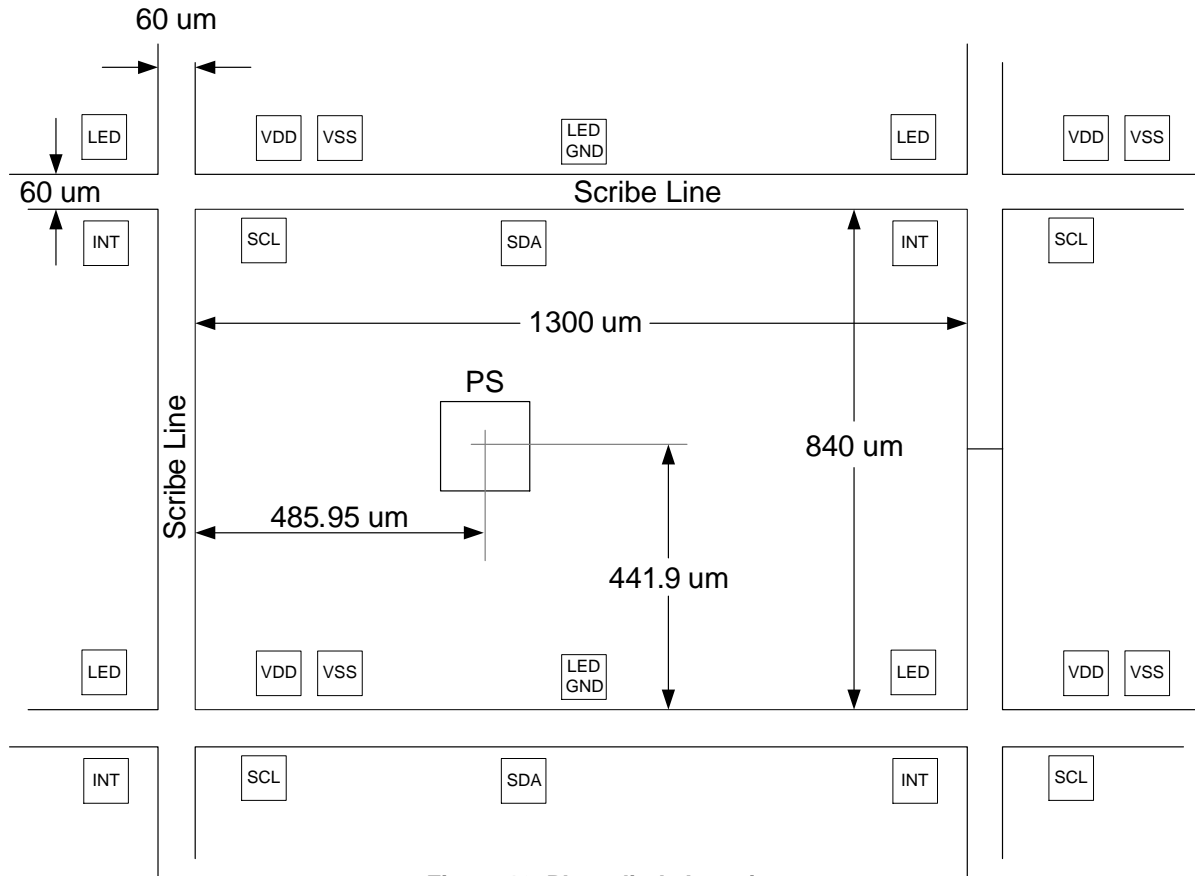

Figure 16. Photodiode Location

**Table 22. BONDING PAD LOCATIONS**

(Dimensions in  $\mu\text{m}$  measured from the lower left corner of the die to the middle of the bond pad) (Note 8)

Pad	Description	X	Y	Pad Size
VDD	Power supply	139	58.4	75x75
VSS	Ground	248.5	58.4	75x75
LED_GND	Ground for IR LED driver	655.85	54.7	75x75
LED	IR LED output	1243.7	65.85	75x75
INT	Interrupt output	1211.7	784.55	75x75
SDA	I2C data signal	554.85	786	75x75
SCL	I2C clock signal	114.25	786	75x75

8. Bond pad material is AL + 0.5% Cu

**Table 23. MECHANICAL DIMENSIONS**

Parameter	Symbol	Min	Typ	Max	Unit
Wafer thickness		700	725	750	$\mu\text{m}$
Wafer diameter			200		mm

ON Semiconductor and the  are registered trademarks of Semiconductor Components Industries, LLC (SCILLC) or its subsidiaries in the United States and/or other countries. SCILLC owns the rights to a number of patents, trademarks, copyrights, trade secrets, and other intellectual property. A listing of SCILLC's product/patent coverage may be accessed at [www.onsemi.com/site/pdf/Patent-Marking.pdf](http://www.onsemi.com/site/pdf/Patent-Marking.pdf). SCILLC reserves the right to make changes without further notice to any products herein. SCILLC makes no warranty, representation or guarantee regarding the suitability of its products for any particular purpose, nor does SCILLC assume any liability arising out of the application or use of any product or circuit, and specifically disclaims any and all liability, including without limitation special, consequential or incidental damages. "Typical" parameters which may be provided in SCILLC data sheets and/or specifications can and do vary in different applications and actual performance may vary over time. All operating parameters, including "Typicals" must be validated for each customer application by customer's technical experts. SCILLC does not convey any license under its patent rights nor the rights of others. SCILLC products are not designed, intended, or authorized for use as components in systems intended for surgical implant into the body, or other applications intended to support or sustain life, or for any other application in which the failure of the SCILLC product could create a situation where personal injury or death may occur. Should Buyer purchase or use SCILLC products for any such unintended or unauthorized application, Buyer shall indemnify and hold SCILLC and its officers, employees, subsidiaries, affiliates, and distributors harmless against all claims, costs, damages, and expenses, and reasonable attorney fees arising out of, directly or indirectly, any claim of personal injury or death associated with such unintended or unauthorized use, even if such claim alleges that SCILLC was negligent regarding the design or manufacture of the part. SCILLC is an Equal Opportunity/Affirmative Action Employer. This literature is subject to all applicable copyright laws and is not for resale in any manner.

## PUBLICATION ORDERING INFORMATION

### LITERATURE FULFILLMENT:

Literature Distribution Center for ON Semiconductor  
P.O. Box 5163, Denver, Colorado 80217 USA  
**Phone:** 303-675-2175 or 800-344-3860 Toll Free USA/Canada  
**Fax:** 303-675-2176 or 800-344-3867 Toll Free USA/Canada  
**Email:** [orderlit@onsemi.com](mailto:orderlit@onsemi.com)

**N. American Technical Support:** 800-282-9855 Toll Free  
USA/Canada  
**Europe, Middle East and Africa Technical Support:**  
Phone: 421 33 790 2910  
**Japan Customer Focus Center**  
Phone: 81-3-5817-1050

**ON Semiconductor Website:** [www.onsemi.com](http://www.onsemi.com)  
**Order Literature:** <http://www.onsemi.com/orderlit>  
For additional information, please contact your local  
Sales Representative