

# LM4839

*LM4839 Stereo 2W Audio Power Amplifiers with DC Volume Control, Bass Boost, and Input Mux*



Literature Number: SNAS132D

# Stereo 2W Audio Power Amplifiers with DC Volume Control, Bass Boost, and Input Mux

## General Description

The LM4839 is a monolithic integrated circuit that provides DC volume control, and stereo bridged audio power amplifiers capable of producing 2W into 4Ω (Note 1) with less than 1.0% THD+N, or 2.2W into 3Ω (Note 2) with less than 1.0% THD+N.

Boomer® audio integrated circuits were designed specifically to provide high quality audio while requiring a minimum amount of external components. The LM4839 incorporates a DC volume control, stereo bridged audio power amplifiers, selectable gain or bass boost, and an input mux making it optimally suited for multimedia monitors, portable radios, desktop, and portable computer applications.

The LM4839 features an externally controlled, low-power consumption shutdown mode, and both a power amplifier and headphone mute for maximum system flexibility and performance.

**Note 1:** When properly mounted to the circuit board, the LM4839LQ and LM4839MTE will deliver 2W into 4Ω. The LM4839MT will deliver 1.1W into 8Ω. See the Application Information section for LM4839LQ and LM4839MTE usage information.

**Note 2:** An LM4839LQ and LM4839MTE that have been properly mounted to the circuit board and forced-air cooled will deliver 2.2W into 3Ω.

## Key Specifications

- P<sub>O</sub> at 1% THD+N
  - into 3Ω (LQ & MTE) 2.2W(typ)
  - into 4Ω (LQ & MTE) 2.0W(typ)
  - into 8Ω (LM4839) (MT, MTE, & LQ) 1.1W(typ)
- Single-ended mode - THD+N at 85mW into 32Ω 1.0%(typ)
- Shutdown current 0.2μA(typ)

## Features

- DC Volume Control Interface
- Input mux
- System Beep Detect
- Stereo switchable bridged/single-ended power amplifiers
- Selectable internal/external gain and bass boost
- "Click and pop" suppression circuitry
- Thermal shutdown protection circuitry

## Applications

- Portable and Desktop Computers
- Multimedia Monitors
- Portable Radios, PDAs, and Portable TVs

## Connection Diagrams

LLP Package

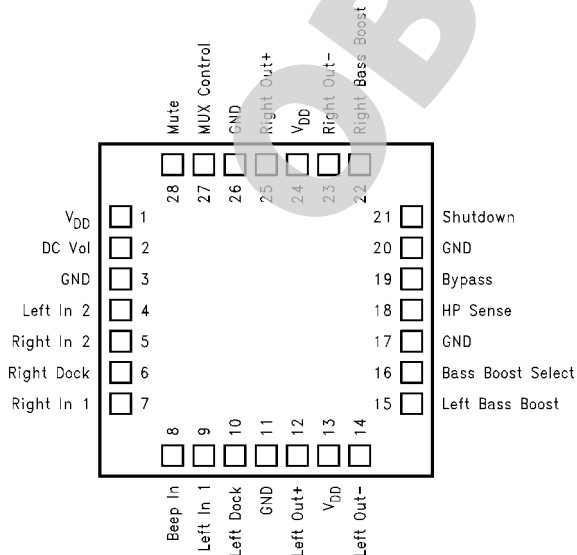

Top View

Order Number LM4839LQ

See NS Package Number LQA028AA for Exposed-DAP LLP

TSSOP Package

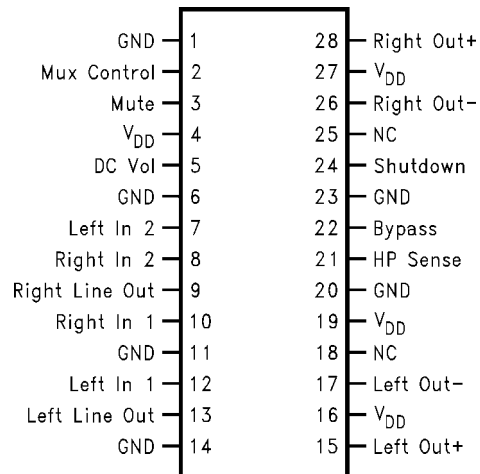

Top View

Order Number LM4839MT

See NS Package Number MTC28 for TSSOP

Order Number LM4839MTE

See NS Package Number MXA28A for Exposed-DAP TSSOP

## Absolute Maximum Ratings (Note 10)

If Military/Aerospace specified devices are required, please contact the National Semiconductor Sales Office/Distributors for availability and specifications.

|  |                          |
|--|--------------------------|
| Supply Voltage   | 6.0V                     |
| Storage Temperature  | -65°C to +150°C          |
| Input Voltage  | -0.3V to $V_{DD} + 0.3V$ |
| Power Dissipation  | Internally limited       |
| ESD Susceptibility (Note 12)   | 2500V                    |
| ESD Susceptibility (Note 13)   | 250V                     |
| Junction Temperature   | 150°C                    |
| Soldering Information  |                          |
| Vapor Phase (60 sec.)  | 215°C                    |
| Infrared (15 sec.)   | 220°C                    |
| See AN-450 "Surface Mounting and their Effects on Product Reliability" for other methods of soldering surface mount devices. |                          |
| $\theta_{JC}$ (typ)—LQA028AA   | 3°C/W                    |

|   |        |
|---|--------|
| $\theta_{JA}$ (typ)—LQA028AA                      | 42°C/W |
| $\theta_{JC}$ (typ)—MTC28                         | 20°C/W |
| $\theta_{JA}$ (typ)—MTC28                         | 80°C/W |
| $\theta_{JC}$ (typ)—MXA28A                        | 2°C/W  |
| $\theta_{JA}$ (typ)—MXA28A (exposed DAP) (Note 4) | 41°C/W |
| $\theta_{JA}$ (typ)—MXA28A (exposed DAP) (Note 3) | 54°C/W |
| $\theta_{JA}$ (typ)—MXA28A (exposed DAP) (Note 5) | 59°C/W |
| $\theta_{JA}$ (typ)—MXA28A (exposed DAP) (Note 6) | 93°C/W |

## Operating Ratings

Temperature Range

$$T_{MIN} \leq T_A \leq T_{MAX}$$

$$-40^\circ\text{C} \leq T_A \leq 85^\circ\text{C}$$

Supply Voltage

$$2.7V \leq V_{DD} \leq 5.5V$$

## Electrical Characteristics for Entire IC

(Note 7, Note 10)

The following specifications apply for  $V_{DD} = 5V$  and  $T_A = 25^\circ\text{C}$  unless otherwise noted.

| Symbol   | Parameter                      | Conditions              | LM4839            |                     | Units (Limits)      |
|----------|--------------------------------|-------------------------|-------------------|---------------------|---------------------|
|          |                                |                         | Typical (Note 14) | Limit (Note 15)     |                     |
| $V_{DD}$ | Supply Voltage                 |                         |                   | 2.7                 | V (min)             |
|          |                                |                         |                   | 5.5                 | V (max)             |
| $I_{DD}$ | Quiescent Power Supply Current | $V_{IN} = 0V, I_O = 0A$ | 15                | 30                  | mA (max)            |
| $I_{SD}$ | Shutdown Current               | $V_{shutdown} = V_{DD}$ | 0.7               | 2.0                 | $\mu\text{A}$ (max) |
| $V_{IH}$ | VIN High on all Logic Inputs   |                         |                   | $0.8 \times V_{DD}$ | V (min)             |
| $V_{IL}$ | VIN Low on all Logic Inputs    |                         |                   | $0.2 \times V_{DD}$ | V (max)             |

## Electrical Characteristics for Volume Attenuators

(Note 7, Note 10)

The following specifications apply for  $V_{DD} = 5V$  and  $T_A = 25^\circ\text{C}$  unless otherwise noted.

| Symbol      | Parameter        | Conditions                                  | LM4839            |                 | Units (Limits) |
|-------------|------------------|---|-------------------|-----------------|----------------|
|             |                  |   | Typical (Note 14) | Limit (Note 15) |                |
| $C_{RANGE}$ | Attenuator Range | Gain with $V_{DCVol} = 5.0V$ , No Load      |                   | $\pm 0.75$      | dB (max)       |
| $C_{RANGE}$ | Attenuator Range | Attenuation with $V_{DCVol} = 0V$ (BM & SE) |                   | -75             | dB (min)       |
| $A_M$       | Mute Attenuation | $V_{mute} = 5V$ , Bridged Mode (BM)         |                   | -78             | dB (min)       |
|             |                  | $V_{mute} = 5V$ , Single-Ended Mode (SE)    |                   | -78             | dB (min)       |

## Electrical Characteristics for Single-Ended Mode Operation

(Note 7, Note 10)

The following specifications apply for  $V_{DD} = 5V$  and  $T_A = 25^\circ C$  unless otherwise noted.

| Symbol     | Parameter                       | Conditions  | LM4839            |                 | Units (Limits) |
|------------|---------------------------------|---|-------------------|-----------------|----------------|
|            |                                 |   | Typical (Note 14) | Limit (Note 15) |                |
| $P_O$      | Output Power                    | THD+N = 1.0%; f = 1kHz; $R_L = 32\Omega$                        | 85                |                 | mW             |
|            |                                 | THD+N = 10%; f = 1 kHz; $R_L = 32\Omega$                        | 95                |                 | mW             |
| THD+N      | Total Harmonic Distortion+Noise | $V_{OUT} = 1V_{RMS}$ , f=1kHz, $R_L = 10k\Omega$ , $A_{VD} = 1$ | 0.065             |                 | %              |
| PSRR       | Power Supply Rejection Ratio    | $C_B = 1.0 \mu F$ , f = 120 Hz, $V_{RIPPLE} = 200 mV_{rms}$     | 58                |                 | dB             |
| SNR        | Signal to Noise Ratio           | $P_{OUT} = 75 mW$ , $R_L = 32\Omega$ , A-Wtd Filter             | 102               |                 | dB             |
| $X_{talk}$ | Channel Separation              | f=1kHz, $C_B = 1.0 \mu F$                                       | 65                |                 | dB             |

## Electrical Characteristics for Bridged Mode Operation

(Note 7, Note 10)

The following specifications apply for  $V_{DD} = 5V$  and  $T_A = 25^\circ C$  unless otherwise noted.

| Symbol     | Parameter                       | Conditions  | LM4839            |                 | Units (Limits) |
|------------|---------------------------------|---|-------------------|-----------------|----------------|
|            |                                 |   | Typical (Note 14) | Limit (Note 15) |                |
| $V_{OS}$   | Output Offset Voltage           | $V_{IN} = 0V$ , No Load   |                   | $\pm 50$        | mV (max)       |
| $P_O$      | Output Power                    | THD + N = 1.0%; f=1kHz; $R_L = 3\Omega$ (Note 8)                              | 2.2               |                 | W              |
|            |                                 | THD + N = 1.0%; f=1kHz; $R_L = 4\Omega$ (Note 9)(Note 15)                     | 2                 |                 | W              |
|            |                                 | THD = 1.5% (max); f = 1 kHz; $R_L = 8\Omega$                                  | 1.1               | 1.0             | W (min)        |
|            |                                 | THD+N = 10%; f = 1 kHz; $R_L = 8\Omega$                                       | 1.5               |                 | W              |
| THD+N      | Total Harmonic Distortion+Noise | $P_O = 1W$ , 20 Hz < f < 20 kHz, $R_L = 8\Omega$ , $A_{VD} = 2$               | 0.3               |                 | %              |
|            |                                 | $P_O = 340 mW$ , $R_L = 32\Omega$   | 1.0               |                 | %              |
| PSRR       | Power Supply Rejection Ratio    | $C_B = 1.0 \mu F$ , f = 120 Hz, $V_{RIPPLE} = 200 mV_{rms}$ ; $R_L = 8\Omega$ | 74                |                 | dB             |
| SNR        | Signal to Noise Ratio           | $V_{DD} = 5V$ , $P_{OUT} = 1.1W$ , $R_L = 8\Omega$ , A-Wtd Filter             | 93                |                 | dB             |
| $X_{talk}$ | Channel Separation              | f=1kHz, $C_B = 1.0 \mu F$   | 70                |                 | dB             |

- Note 3:** The  $\theta_{JA}$  given is for an MXA28A package whose exposed-DAP is soldered to an exposed 2in<sup>2</sup> piece of 1 ounce printed circuit board copper.
- Note 4:** The  $\theta_{JA}$  given is for an MXA28A package whose exposed-DAP is soldered to a 2in<sup>2</sup> piece of 1 ounce printed circuit board copper on a bottom side layer through 21 8mil vias.
- Note 5:** The  $\theta_{JA}$  given is for an MXA28A package whose exposed-DAP is soldered to an exposed 1in<sup>2</sup> piece of 1 ounce printed circuit board copper.
- Note 6:** The  $\theta_{JA}$  given is for an MXA28A package whose exposed-DAP is not soldered to any copper.
- Note 7:** All voltages are measured with respect to the ground pins, unless otherwise specified. All specifications are tested using the typical application as shown in Figure 2.
- Note 8:** When driving 3 $\Omega$  loads from a 5V supply the LM4839MTE exposed DAP must be soldered to the circuit board and forced-air cooled.
- Note 9:** When driving 4 $\Omega$  loads from a 5V supply the LM4839MTE exposed DAP must be soldered to the circuit board.
- Note 10:** Absolute Maximum Ratings indicate limits beyond which damage to the device may occur. Operating Ratings indicate conditions for which the device is functional, but do not guarantee specific performance limits. Electrical Characteristics state DC and AC electrical specifications under particular test conditions which guarantee specific performance limits. This assumes that the device is within the Operating Ratings. Specifications are not guaranteed for parameters where no limit is given, however, the typical value is a good indication of device performance.
- Note 11:** The maximum power dissipation must be derated at elevated temperatures and is dictated by  $T_{JMAX}$ ,  $\theta_{JA}$ , and the ambient temperature  $T_A$ . The maximum allowable power dissipation is  $P_{DMAX} = (T_{JMAX} - T_A) / \theta_{JA}$ . For the LM4839MT,  $T_{JMAX} = 150^\circ\text{C}$ , and the typical junction-to-ambient thermal resistance, when board mounted, is 80°C/W assuming the MTC28 package.
- Note 12:** Human body model, 100 pF discharged through a 1.5 k $\Omega$  resistor.
- Note 13:** Machine Model, 220 pF–240 pF discharged through all pins.
- Note 14:** Typicals are measured at 25°C and represent the parametric norm.
- Note 15:** Datasheet min/max specification limits are guaranteed by design, test, or statistical analysis. Limits are guaranteed to National's AOQL (Average Outgoing Quality Level).

OBSOLETE

# Typical Application

LM4839

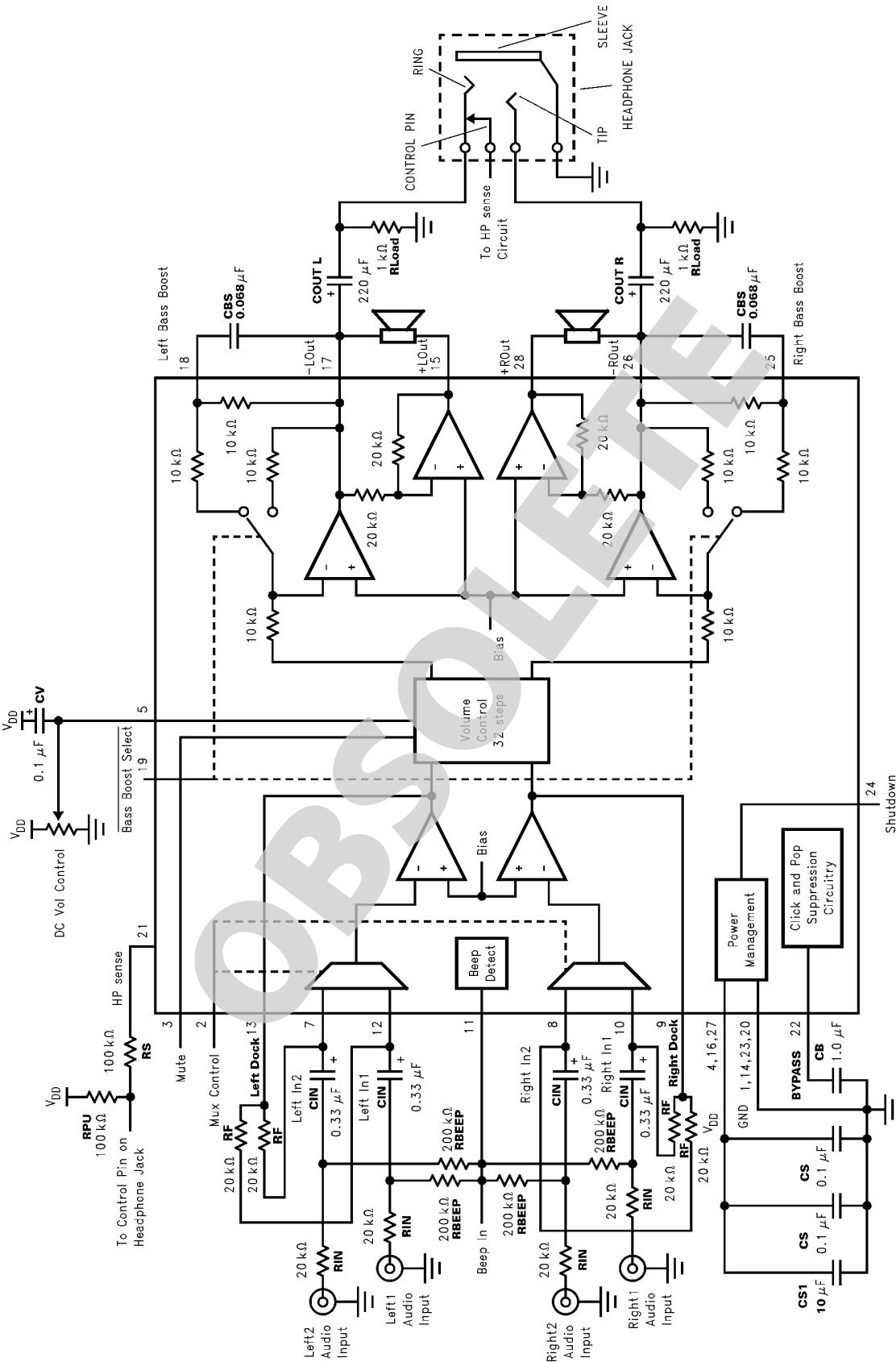

FIGURE 1. Typical Application Circuit ( MT & MTE pinout )

20013403

## Truth Table for Logic Inputs (Note 16)

| Mute | Mux Control | HP Sense | Inputs Selected       | Bridged Output  | Single-Ended Output |
|------|-------------|----------|-----------------------|-----------------|---------------------|
| 0    | 0           | 0        | Left In 1, Right In 1 | Vol. Adjustable | -                   |
| 0    | 0           | 1        | Left In 1, Right In 1 | Muted           | Vol. Adjustable     |
| 0    | 1           | 0        | Left In 2, Right In 2 | Vol. Adjustable | -                   |
| 0    | 1           | 1        | Left In 2, Right In 2 | Muted           | Vol. Adjustable     |
| 1    | X           | X        | -                     | Muted           | Muted               |

**Note 16:** If system beep is detected on the Beep in pin (pin 11) and beep is fed to inputs, the system beep will be passed through the bridged amplifier regardless of the logic of the Mute, HP sense, or DC Volume Control pins.

OBSOLETE

## Typical Performance Characteristics

### MTE Specific Characteristics

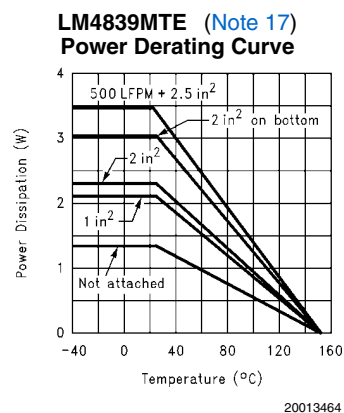
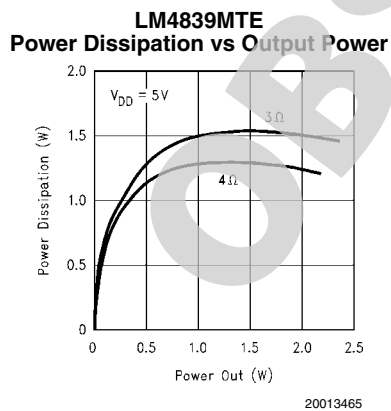
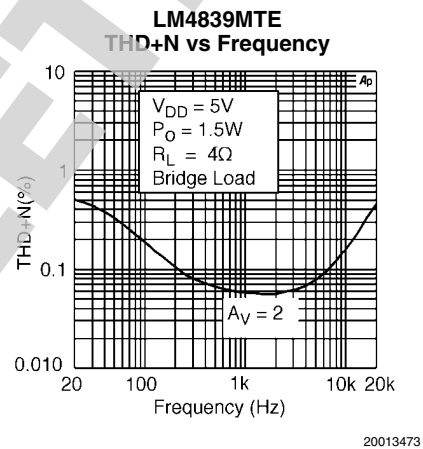
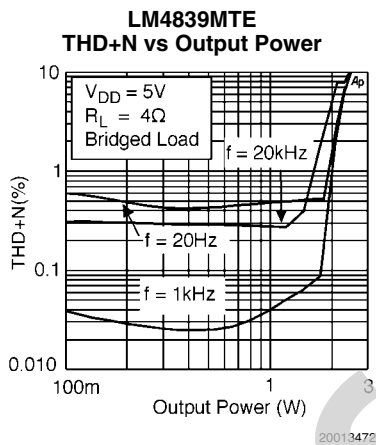
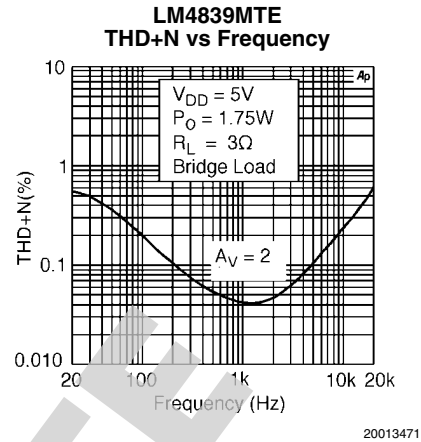
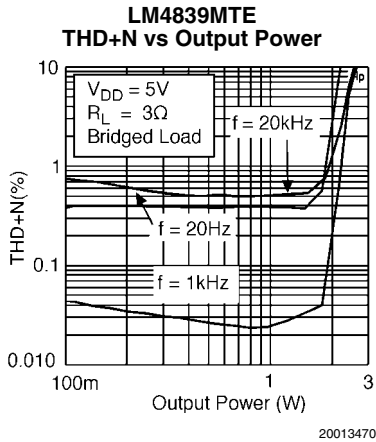

**Note 17:** These curves show the thermal dissipation ability of the LM4839MTE at different ambient temperatures given these conditions:

**500LFPM + 2in<sup>2</sup>:** The part is soldered to a 2in<sup>2</sup>, 1 oz. copper plane with 500 linear feet per minute of forced-air flow across it.

**2in<sup>2</sup>on bottom:** The part is soldered to a 2in<sup>2</sup>, 1oz. copper plane that is on the bottom side of the PC board through 21 8 mil vias.

**2in<sup>2</sup>:** The part is soldered to a 2in<sup>2</sup>, 1oz. copper plane.

**1in<sup>2</sup>:** The part is soldered to a 1in<sup>2</sup>, 1oz. copper plane.

**Not Attached:** The part is not soldered down and is not forced-air cooled.



# Typical Performance Characteristics

## Non-MTE Specific Characteristics

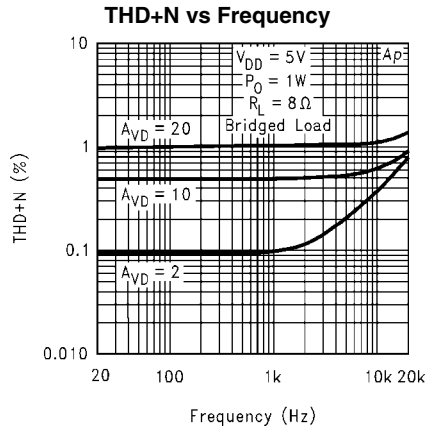

20013457

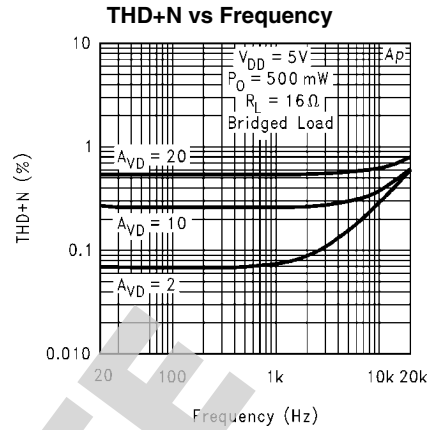

20013458

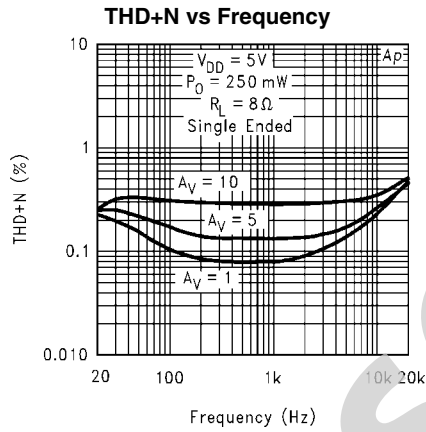

20013414

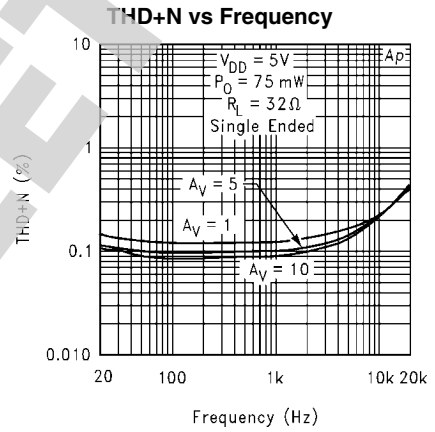

20013415

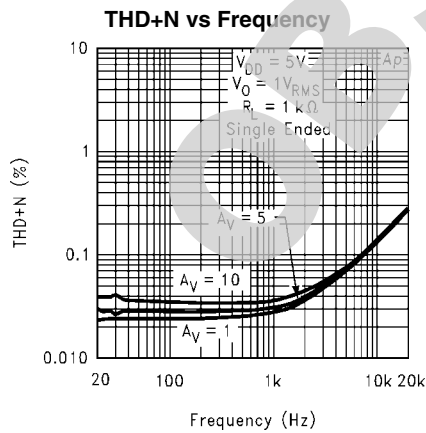

20013416

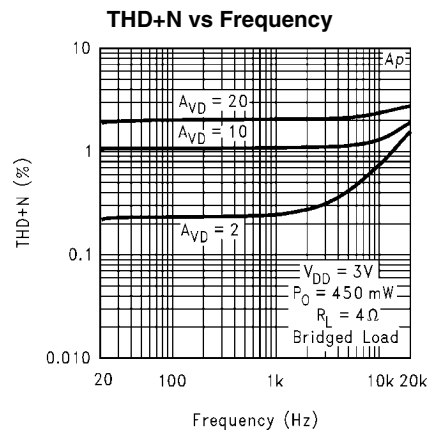

20013417

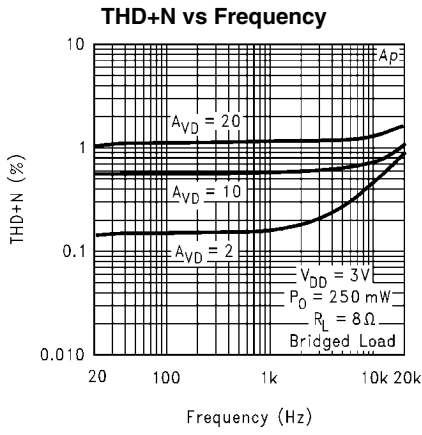

20013418

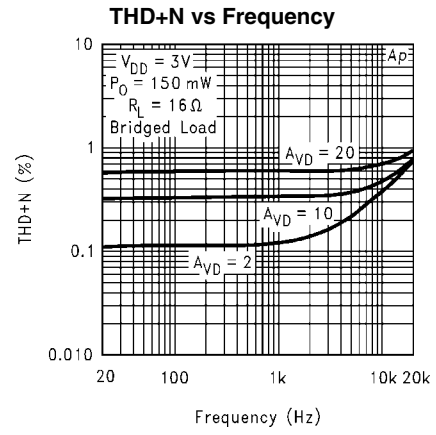

20013419

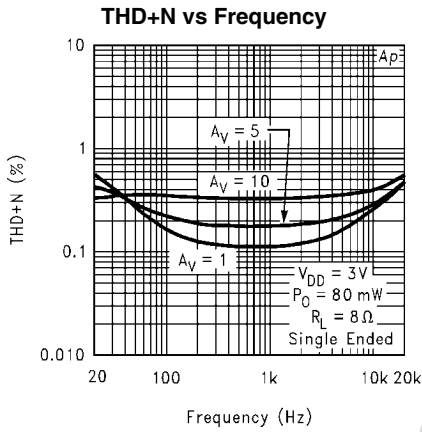

20013420

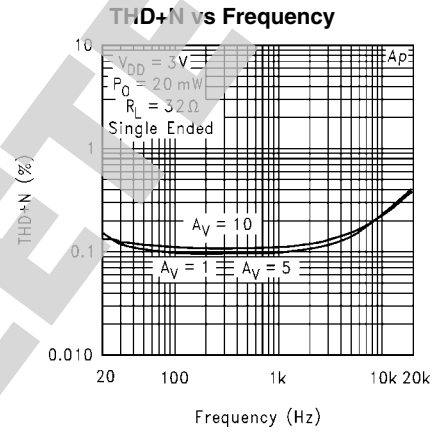

20013421

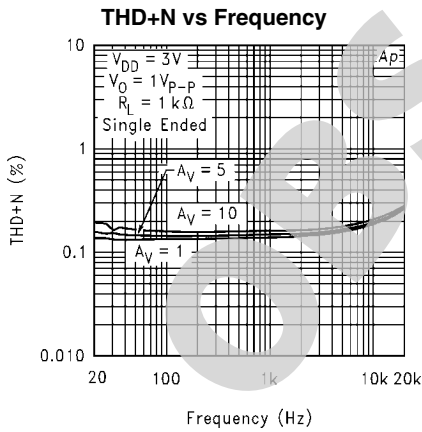

20013422

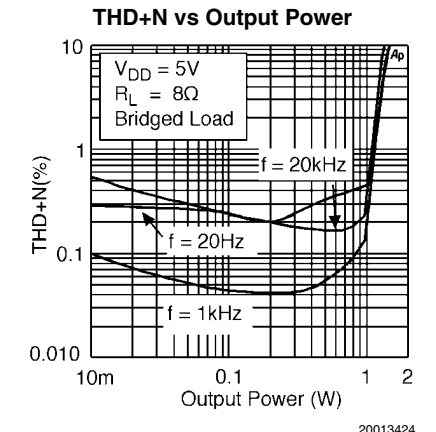

20013424

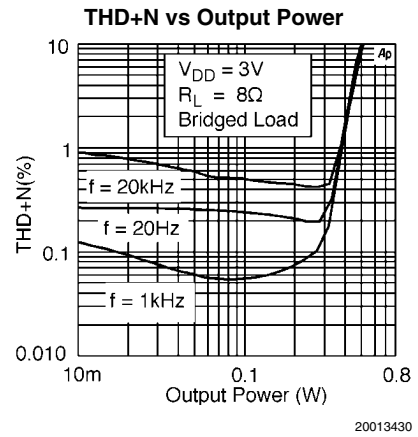
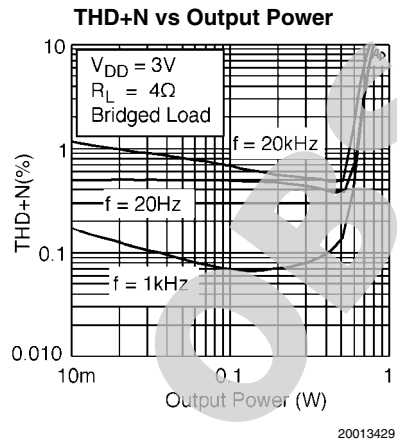
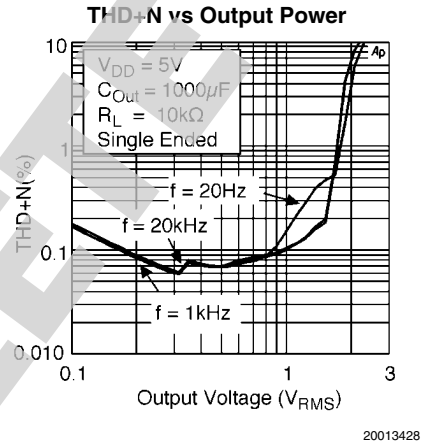
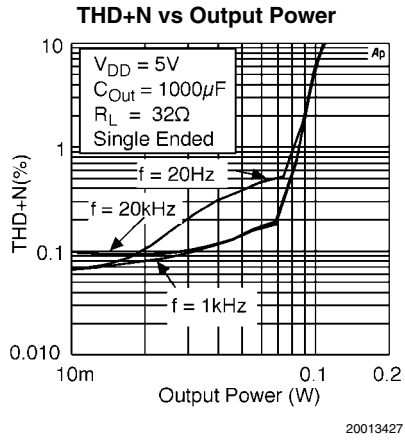
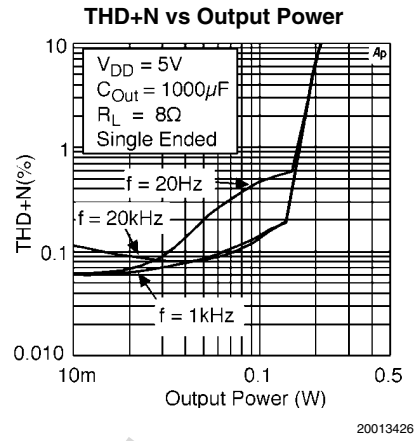
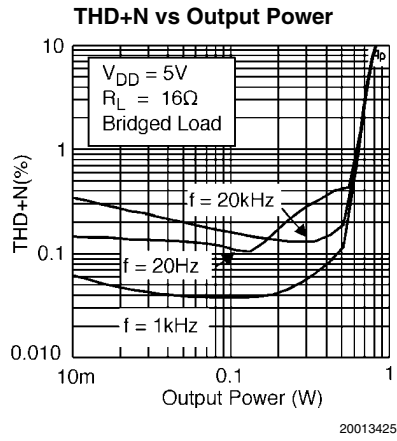

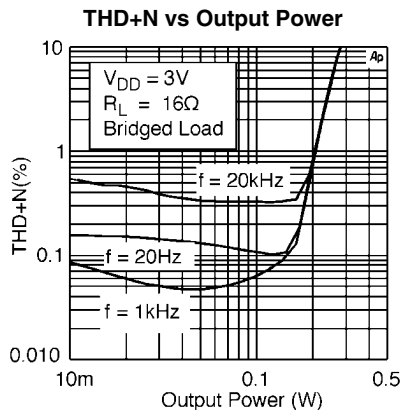

20013431

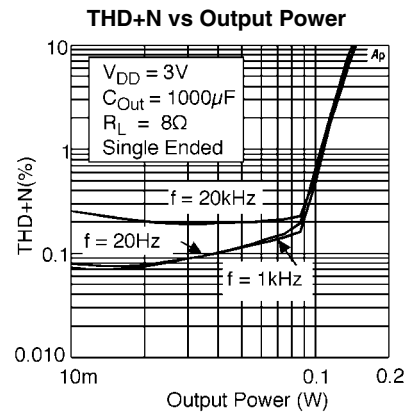

20013432

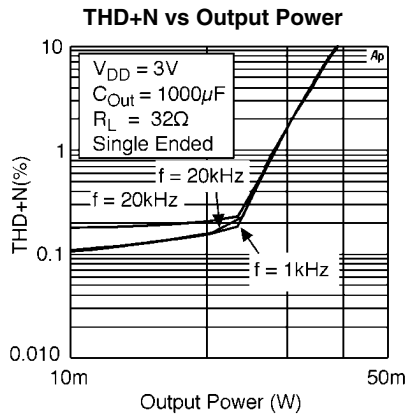

20013433

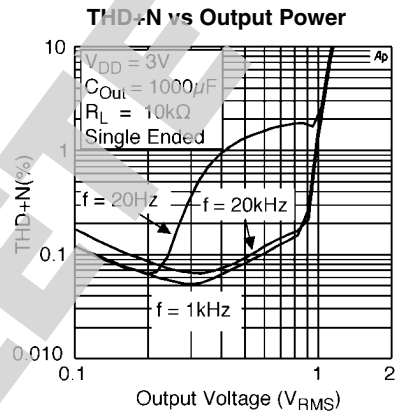

20013434

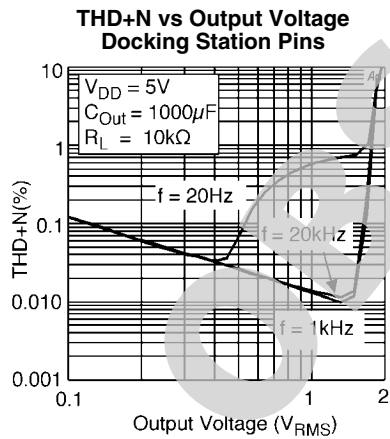

20013459

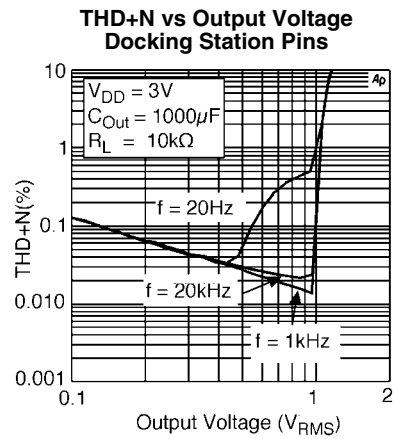

20013460

**Output Power vs Load Resistance**

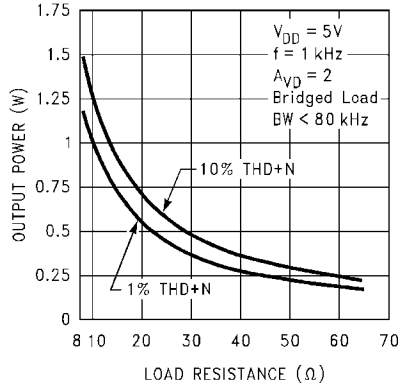

20013462

**Output Power vs Load Resistance**

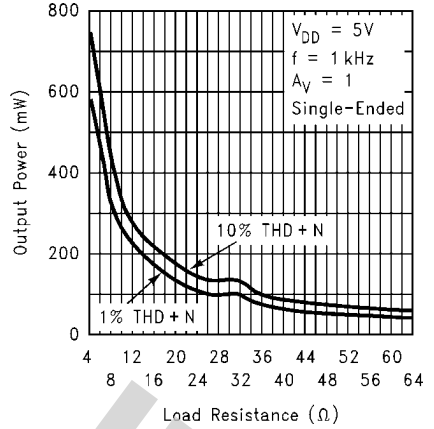

20013406

**Output Power vs Load Resistance**

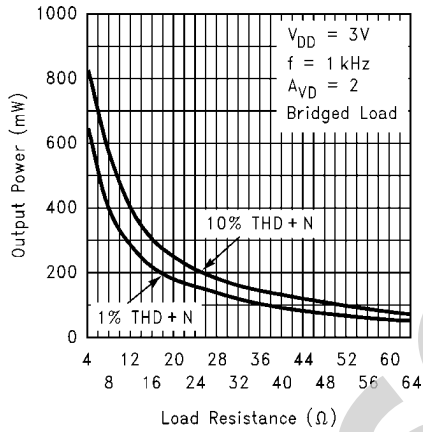

20013407

**Power Supply Rejection Ratio**

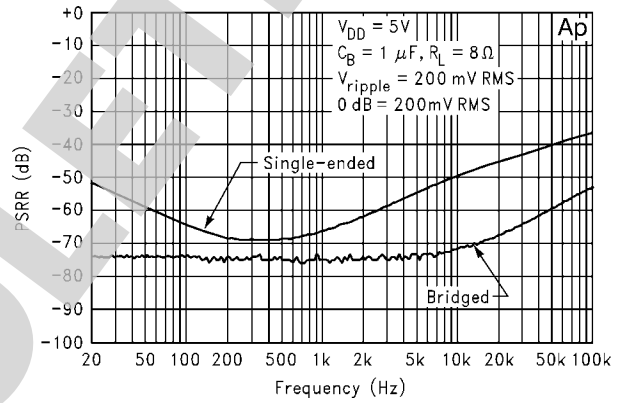

20013435

**Dropout Voltage**

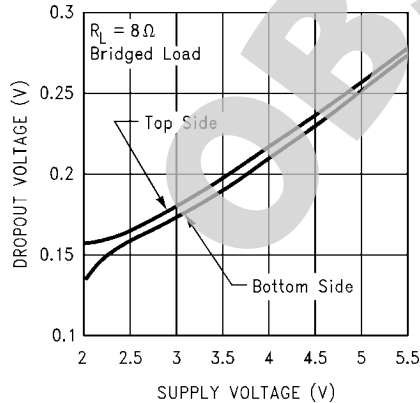

20013453

**Output Power vs Load Resistance**

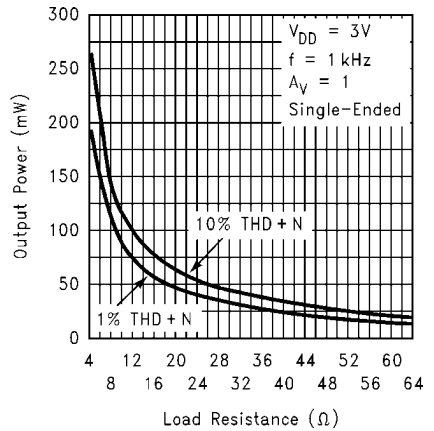

20013408

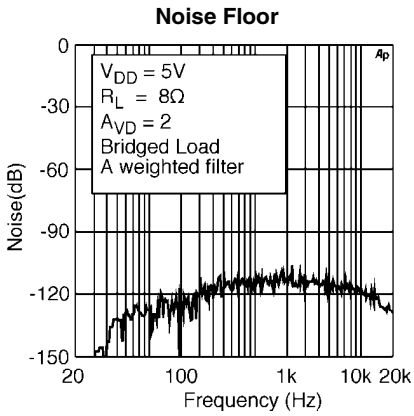

20013441

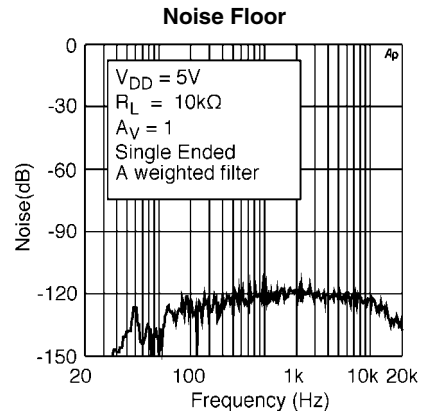

20013442

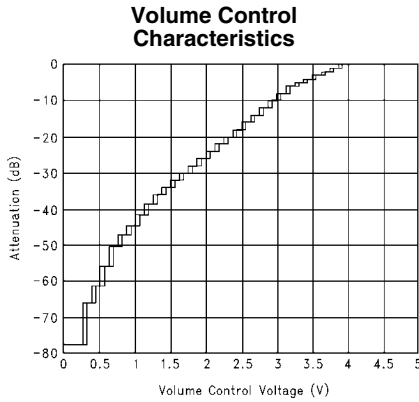

20013436

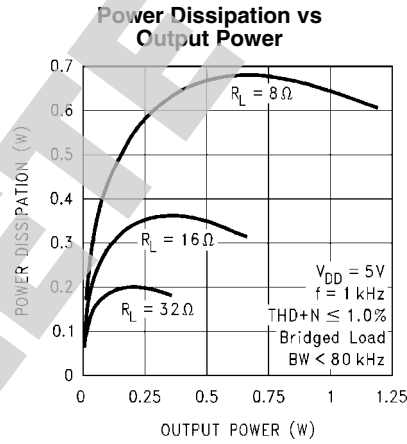

20013451

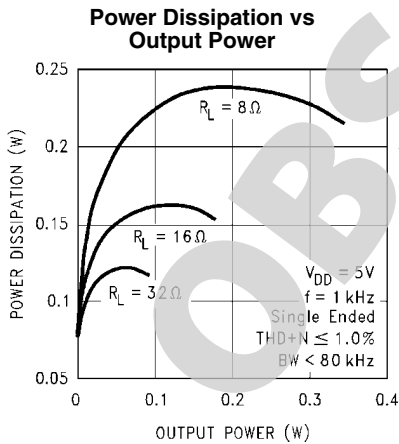

20013452

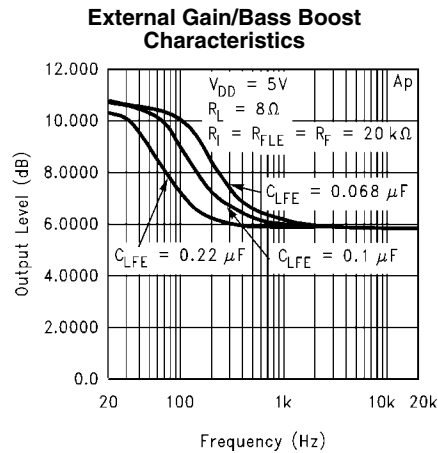

20013461

**Power Derating Curve**

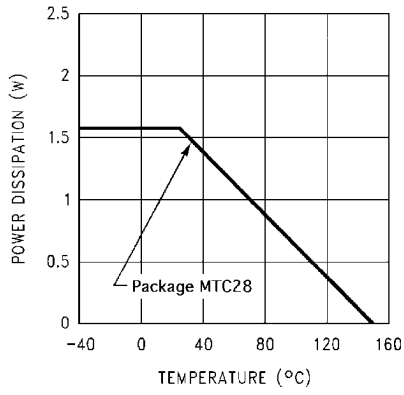

20013463

**Crosstalk**

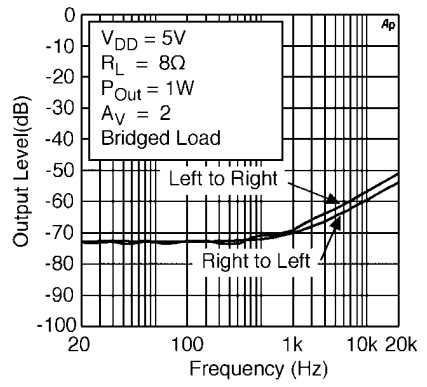

20013449

**Crosstalk**

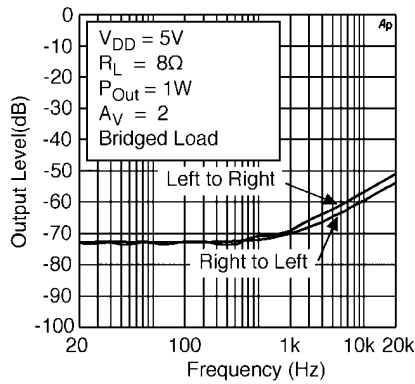

20013450

**Output Power vs Supply voltage**

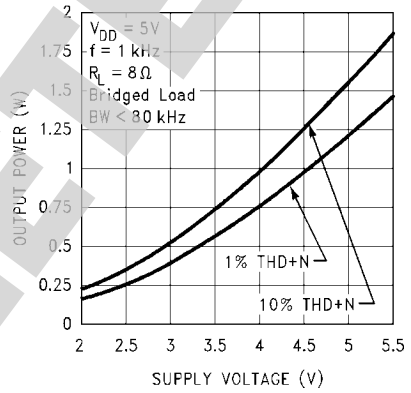

20013454

**Output Power vs Supply Voltage**

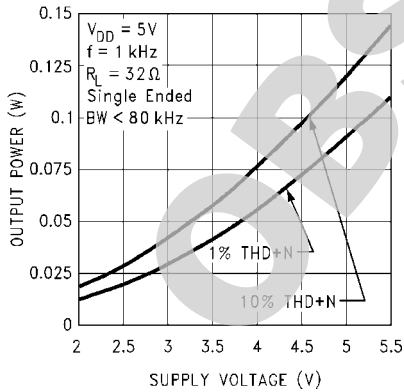

20013456

**Supply Current vs Supply Voltage**

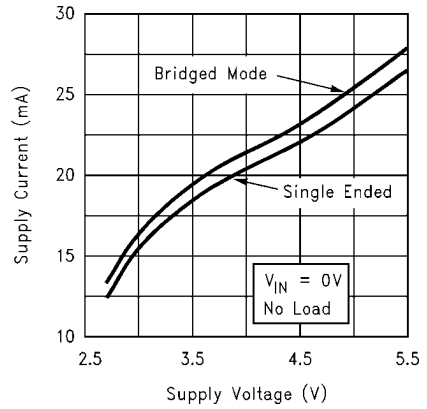

20013409

# Typical Performance Characteristics

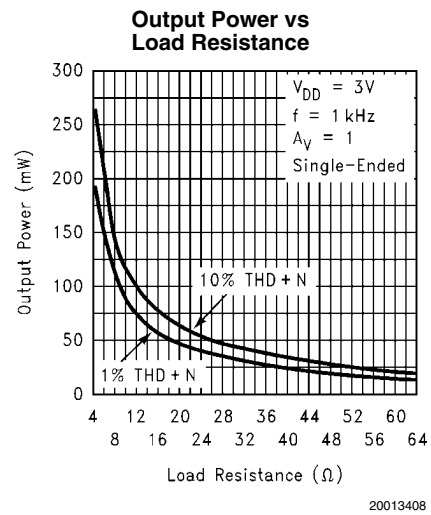
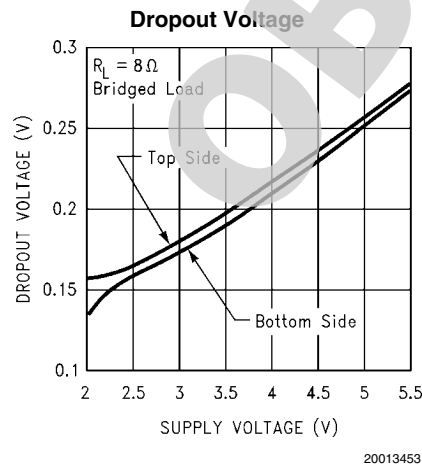
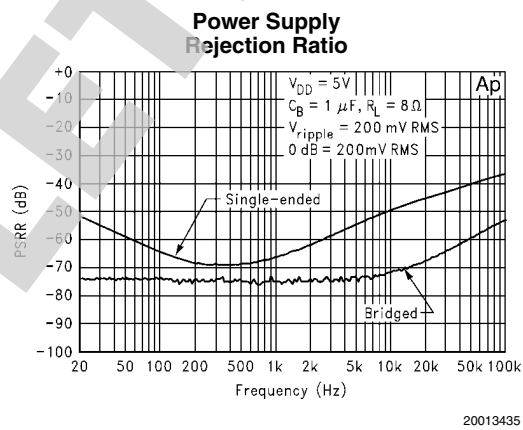
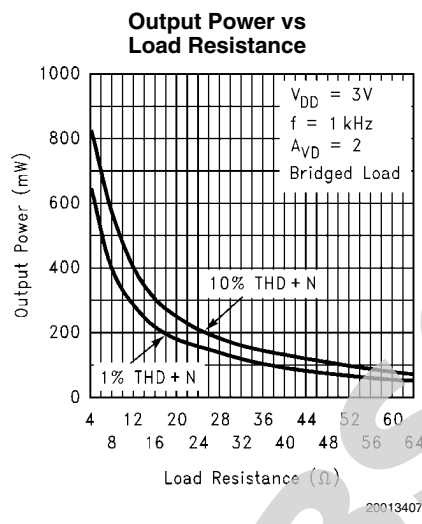
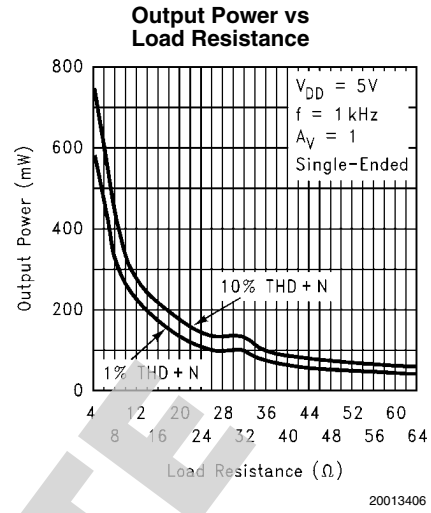
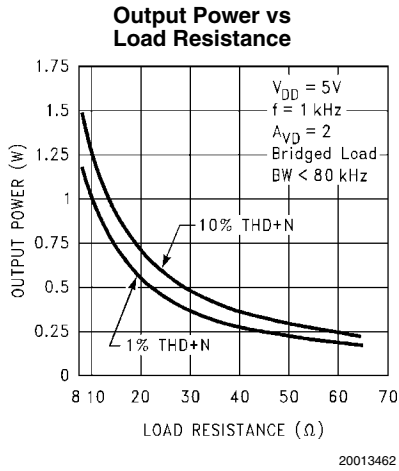



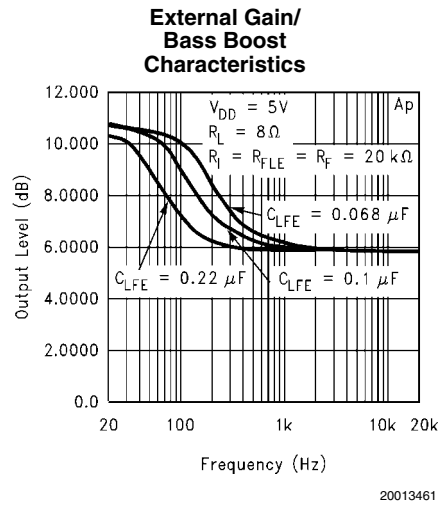
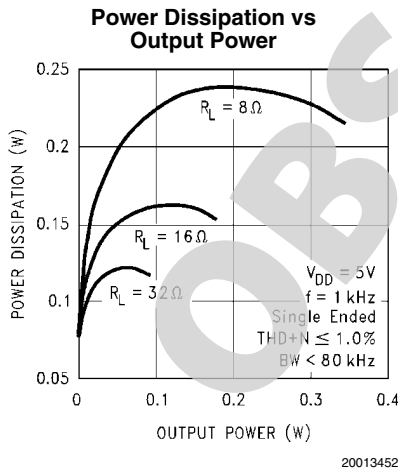
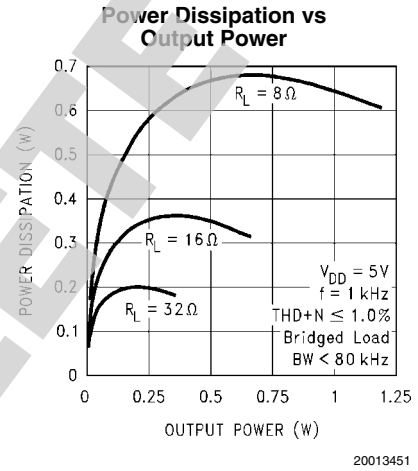
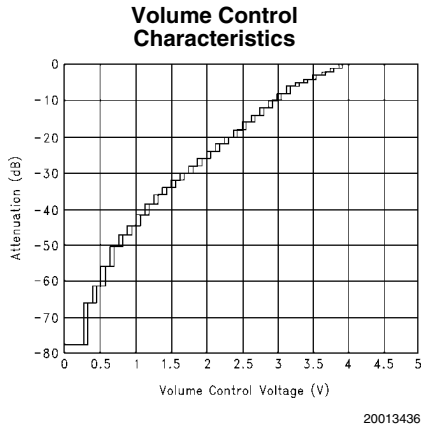
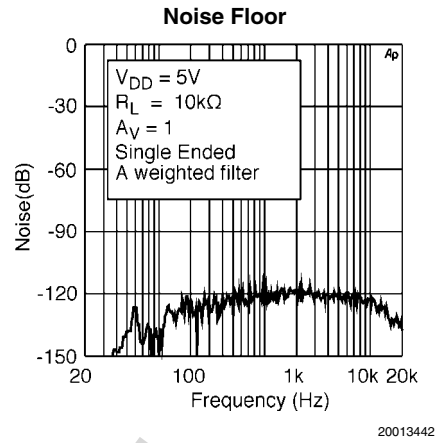
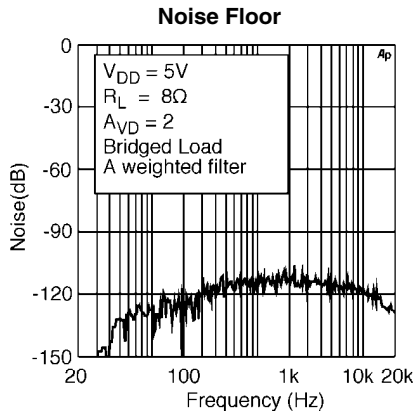

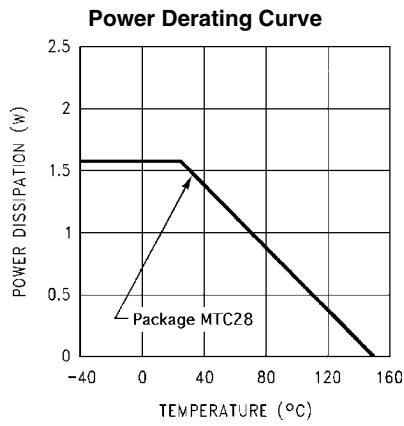

20013463

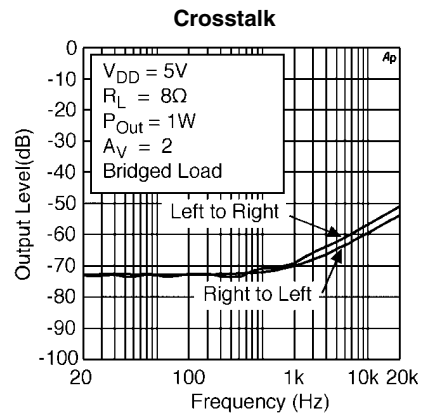

20013449

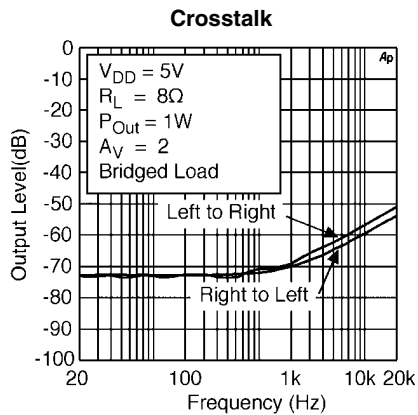

20013450

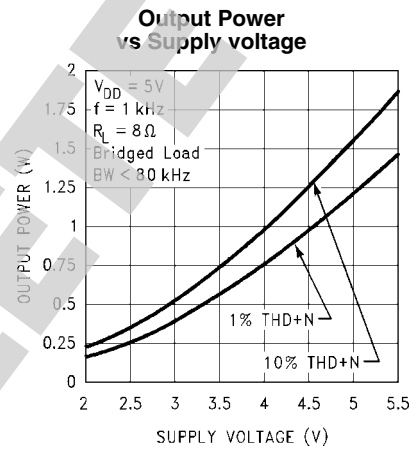

20013454

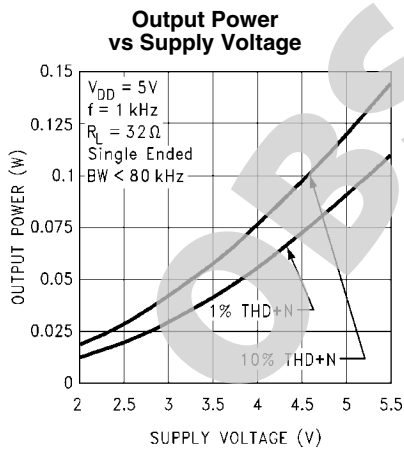

20013456

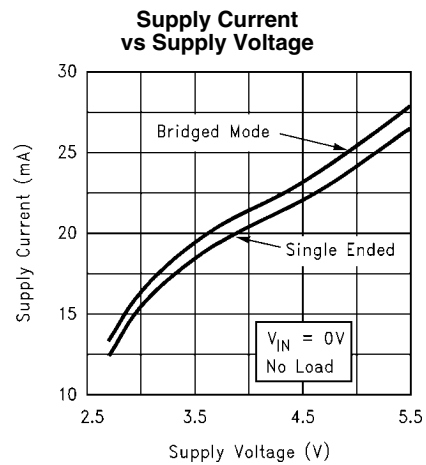

20013409

## Application Information

### EXPOSED-DAP MOUNTING CONSIDERATIONS

The LM4839's exposed-DAP (die attach paddle) packages (MTE, LQ) provide a low thermal resistance between the die and the PCB to which the part is mounted and soldered. This allows rapid heat transfer from the die to the surrounding PCB copper traces, ground plane and, finally, surrounding air. The result is a low voltage audio power amplifier that produces 2.1W at  $\leq 1\%$  THD with a  $4\Omega$  load. This high power is achieved through careful consideration of necessary thermal design. Failing to optimize thermal design may compromise the LM4839's high power performance and activate unwanted, though necessary, thermal shutdown protection.

The MTE and LQ packages must have their exposed DAPs soldered to a grounded copper pad on the PCB. The DAP's PCB copper pad is connected to a large plane of continuous unbroken copper. This plane forms a thermal mass and heat sink and radiation area. Place the heat sink area on either outside plane in the case of a two-sided PCB, or on an inner layer of a board with more than two layers. Connect the DAP copper pad to the inner layer or backside copper heat sink area with 32(4x8) (MTE) or 6(3x2) (LQ) vias. The via diameter should be 0.012in–0.013in with a 1.27mm pitch. Ensure efficient thermal conductivity by plating-through and solder-filling the vias.

Best thermal performance is achieved with the largest practical copper heat sink area. If the heatsink and amplifier share the same PCB layer, a nominal 2.5in<sup>2</sup> (min) area is necessary for 5V operation with a  $4\Omega$  load. Heatsink areas not placed on the same PCB layer as the LM4839 should be 5in<sup>2</sup> (min) for the same supply voltage and load resistance. The last two area recommendations apply for 25°C ambient temperature. Increase the area to compensate for ambient temperatures above 25°C. In systems using cooling fans, the LM4839MTE can take advantage of forced air cooling. With an air flow rate of 450 linear-feet per minute and a 2.5in<sup>2</sup> exposed copper or 5.0in<sup>2</sup> inner layer copper plane heatsink, the LM4839MTE can continuously drive a  $3\Omega$  load to full power. The LM4839LQ achieves the same output power level without forced air cooling. In all circumstances and conditions, the junction temperature must be held below 150°C to prevent activating the LM4839's thermal shutdown protection. The LM4839's power de-rating curve in the **Typical Performance Characteristics** shows the maximum power dissipation versus temperature. Example PCB layouts for the exposed-DAP TSSOP and LQ packages are shown in the **Demonstration Board Layout** section. Further detailed and specific information concerning PCB layout, fabrication, and mounting an LQ (LLP) package is available in National Semiconductor's AN1187.

### PCB LAYOUT AND SUPPLY REGULATION CONSIDERATIONS FOR DRIVING $3\Omega$ AND $4\Omega$ LOADS

Power dissipated by a load is a function of the voltage swing across the load and the load's impedance. As load impedance decreases, load dissipation becomes increasingly dependent on the interconnect (PCB trace and wire) resistance between the amplifier output pins and the load's connections. Residual trace resistance causes a voltage drop, which results in power dissipated in the trace and not in the load as desired. For example,  $0.1\Omega$  trace resistance reduces the output power dissipated by a  $4\Omega$  load from 2.1W to 2.0W. This problem of decreased load dissipation is exacerbated as load impedance decreases. Therefore, to maintain the highest load dissipation and widest output voltage swing, PCB traces that connect the output pins to a load must be as wide as possible.

Poor power supply regulation adversely affects maximum output power. A poorly regulated supply's output voltage decreases with increasing load current. Reduced supply voltage causes decreased headroom, output signal clipping, and reduced output power. Even with tightly regulated supplies, trace resistance creates the same effects as poor supply regulation. Therefore, making the power supply traces as wide as possible helps maintain full output voltage swing.

### BRIDGE CONFIGURATION EXPLANATION

As shown in **Figure 1**, the LM4839 output stage consists of two pairs of operational amplifiers, forming a two-channel (channel A and channel B) stereo amplifier. (Though the following discusses channel A, it applies equally to channel B.)

**Figure 1** shows that the first amplifier's negative (-) output serves as the second amplifier's input. This results in both amplifiers producing signals identical in magnitude, but 180° out of phase. Taking advantage of this phase difference, a load is placed between -OUTA and +OUTA and driven differentially (commonly referred to as "bridge mode"). This results in a differential gain of

$$A_{VD} = 2 * (R_f/R_i) \quad (1)$$

Bridge mode amplifiers are different from single-ended amplifiers that drive loads connected between a single amplifier's output and ground. For a given supply voltage, bridge mode has a distinct advantage over the single-ended configuration: **its differential output doubles the voltage swing across the load.** This produces four times the output power when compared to a single-ended amplifier under the same conditions. This increase in attainable output power assumes that the amplifier is not current limited or that the output signal is not clipped. To ensure minimum output signal clipping when choosing an amplifier's closed-loop gain, refer to the **Audio Power Amplifier Design** section.

Another advantage of the differential bridge output is no net DC voltage across the load. This is accomplished by biasing channel A's and channel B's outputs at half-supply. This eliminates the coupling capacitor that single supply, single-ended amplifiers require. Eliminating an output coupling capacitor in a single-ended configuration forces a single-supply amplifier's half-supply bias voltage across the load. This increases internal IC power dissipation and may permanently damage loads such as speakers.

### POWER DISSIPATION

Power dissipation is a major concern when designing a successful single-ended or bridged amplifier. Equation (2) states the maximum power dissipation point for a single-ended amplifier operating at a given supply voltage and driving a specified output load.

$$P_{DMAX} = (V_{DD})^2 / (2T^2R_L) \quad \text{Single-Ended} \quad (2)$$

However, a direct consequence of the increased power delivered to the load by a bridge amplifier is higher internal power dissipation for the same conditions.

The LM4839 has two operational amplifiers per channel. The maximum internal power dissipation per channel operating in the bridge mode is four times that of a single-ended amplifier. From Equation (3), assuming a 5V power supply and a  $4\Omega$  load, the maximum single channel power dissipation is 1.27W or 2.54W for stereo operation.

$$P_{\text{DMAX}} = 4 * (V_{\text{DD}})^2 / (2\pi^2 R_L) \quad \text{Bridge Mode} \quad (3)$$

The LM4839's power dissipation is twice that given by Equation (2) or Equation (3) when operating in the single-ended mode or bridge mode, respectively. Twice the maximum power dissipation point given by Equation (3) must not exceed the power dissipation given by Equation (4):

$$P_{\text{DMAX}}' = (T_{\text{JMAX}} - T_A) / \theta_{\text{JA}} \quad (4)$$

The LM4839's  $T_{\text{JMAX}} = 150^\circ\text{C}$ . In the LQ package soldered to a DAP pad that expands to a copper area of  $5\text{in}^2$  on a PCB, the LM4839's  $\theta_{\text{JA}}$  is  $20^\circ\text{C/W}$ . In the MTE package soldered to a DAP pad that expands to a copper area of  $2\text{in}^2$  on a PCB, the LM4839's  $\theta_{\text{JA}}$  is  $41^\circ\text{C/W}$ . For the LM4839MT package,  $\theta_{\text{JA}} = 80^\circ\text{C/W}$ . At any given ambient temperature  $T_A$ , use Equation (4) to find the maximum internal power dissipation supported by the IC packaging. Rearranging Equation (4) and substituting  $P_{\text{DMAX}}$  for  $P_{\text{DMAX}}'$  results in Equation (5). This equation gives the maximum ambient temperature that still allows maximum stereo power dissipation without violating the LM4839's maximum junction temperature.

$$T_A = T_{\text{JMAX}} - 2 * P_{\text{DMAX}} \theta_{\text{JA}} \quad (5)$$

For a typical application with a 5V power supply and an 4Ω load, the maximum ambient temperature that allows maximum stereo power dissipation without exceeding the maximum junction temperature is approximately  $99^\circ\text{C}$  for the LQ package and  $45^\circ\text{C}$  for the MTE package.

$$T_{\text{JMAX}} = P_{\text{DMAX}} \theta_{\text{JA}} + T_A \quad (6)$$

Equation (6) gives the maximum junction temperature  $T_{\text{JMAX}}$ . If the result violates the LM4839's  $T_{\text{JMAX}} = 150^\circ\text{C}$ , reduce the maximum junction temperature by reducing the power supply voltage or increasing the load resistance. Further allowance should be made for increased ambient temperatures.

The above examples assume that a device is a surface mount part operating around the maximum power dissipation point. Since internal power dissipation is a function of output power, higher ambient temperatures are allowed as output power or duty cycle decreases.

If the result of Equation (2) is greater than that of Equation (3), then decrease the supply voltage, increase the load impedance, or reduce the ambient temperature. If these measures are insufficient, a heat sink can be added to reduce  $\theta_{\text{JA}}$ . The heat sink can be created using additional copper area around the package, with connections to the ground pin (s), supply pin and amplifier output pins. External, solder attached SMT heatsinks such as the Thermalloy 7106D can also improve power dissipation. When adding a heat sink, the  $\theta_{\text{JA}}$  is the sum of  $\theta_{\text{JC}}$ ,  $\theta_{\text{CS}}$ , and  $\theta_{\text{SA}}$ . ( $\theta_{\text{JC}}$  is the junction-to-case thermal impedance,  $\theta_{\text{CS}}$  is the case-to-sink thermal impedance, and  $\theta_{\text{SA}}$  is the sink-to-ambient thermal impedance.) Refer to the **Typical Performance Characteristics** curves for power dissipation information at lower output power levels.

## POWER SUPPLY BYPASSING

As with any power amplifier, proper supply bypassing is critical for low noise performance and high power supply rejection. Applications that employ a 5V regulator typically use a  $10\ \mu\text{F}$  in parallel with a  $0.1\ \mu\text{F}$  filter capacitor to stabilize the regulator's output, reduce noise on the supply line, and improve the supply's transient response. However, their presence does not eliminate the need for a local  $1.0\ \mu\text{F}$  tantalum bypass capacitance connected between the LM4839's supply pins and ground. Do not substitute a ceramic capacitor for the tantalum. Doing so may cause oscillation. Keep the length of leads and traces that connect capacitors between the LM4839's power supply pin and ground as short as possible. Connecting a  $1\ \mu\text{F}$  capacitor,  $C_B$ , between the BYPASS pin and ground improves the internal bias voltage's stability and improves the amplifier's PSRR. The PSRR improvements increase as the bypass pin capacitor value increases. Too large a capacitor, however, increases turn-on time and can compromise the amplifier's click and pop performance. The selection of bypass capacitor values, especially  $C_B$ , depends on desired PSRR requirements, click and pop performance (as explained in the section, **Proper Selection of External Components**), system cost, and size constraints.

## PROPER SELECTION OF EXTERNAL COMPONENTS

Optimizing the LM4839's performance requires properly selecting external components. Though the LM4839 operates well when using external components with wide tolerances, best performance is achieved by optimizing component values.

The LM4839 is unity-gain stable, giving a designer maximum design flexibility. The gain should be set to no more than a given application requires. This allows the amplifier to achieve minimum THD+N and maximum signal-to-noise ratio. These parameters are compromised as the closed-loop gain increases. However, low gain circuits demand input signals with greater voltage swings to achieve maximum output power. Fortunately, many signal sources such as audio CODECs have outputs of  $1V_{\text{RMS}}$  ( $2.83V_{\text{P-P}}$ ). Please refer to the **Audio Power Amplifier Design** section for more information on selecting the proper gain.

## Input Capacitor Value Selection

Amplifying the lowest audio frequencies requires a high value input coupling capacitor ( $0.33\ \mu\text{F}$  in Figure 1). A high value capacitor can be expensive and may compromise space efficiency in portable designs. In many cases, however, the speakers used in portable systems, whether internal or external, have little ability to reproduce signals below 150Hz. Applications using speakers with this limited frequency response reap little improvement by using a large input capacitor.

Besides effecting system cost and size, the input coupling capacitor has an affect on the LM4835's click and pop performance. When the supply voltage is first applied, a transient (pop) is created as the charge on the input capacitor changes from zero to a quiescent state. The magnitude of the pop is directly proportional to the input capacitor's size. Higher value capacitors need more time to reach a quiescent DC voltage (usually  $V_{\text{DD}}/2$ ) when charged with a fixed current. The amplifier's output charges the input capacitor through the feedback resistor,  $R_f$ . Thus, pops can be minimized by selecting an input capacitor value that is no higher than necessary to meet the desired  $-3\text{dB}$  frequency.

As shown in Figure 1, the input resistors ( $R_{IN} = 20K$ ) and the input capacitors ( $C_{IN} = 0.33\mu F$ ) produce a  $-6dB$  high pass filter cutoff frequency that is found using Equation (7).

$$f_{-6dB} = \frac{1}{2\pi R_{IN} C_1} \quad (7)$$

As an example when using a speaker with a low frequency limit of 150Hz, the input coupling capacitor using Equation (7), is  $0.063\mu F$ . The  $0.33\mu F$  input coupling capacitor shown in Figure 1 allows the LM4839 to drive high efficiency, full range speaker whose response extends below 30Hz.

### OPTIMIZING CLICK AND POP REDUCTION PERFORMANCE

The LM4839 contains circuitry that minimizes turn-on and shutdown transients or "clicks and pops". For this discussion, turn-on refers to either applying the power supply voltage or when the shutdown mode is deactivated. While the power supply is ramping to its final value, the LM4839's internal amplifiers are configured as unity gain buffers. An internal current source changes the voltage of the BYPASS pin in a controlled, linear manner. Ideally, the input and outputs track the voltage applied to the BYPASS pin. The gain of the internal amplifiers remains unity until the voltage on the bypass pin reaches  $1/2 V_{DD}$ . As soon as the voltage on the bypass pin is stable, the device becomes fully operational. Although the BYPASS pin current cannot be modified, changing the size of  $C_B$  alters the device's turn-on time and the magnitude of "clicks and pops". Increasing the value of  $C_B$  reduces the magnitude of turn-on pops. However, this presents a tradeoff: as the size of  $C_B$  increases, the turn-on time increases. There is a linear relationship between the size of  $C_B$  and the turn-on time. Here are some typical turn-on times for various values of  $C_B$ :

| $C_B$       | $T_{ON}$ |
|-------------|----------|
| $0.01\mu F$ | 2ms      |
| $0.1\mu F$  | 20ms     |
| $0.22\mu F$ | 44ms     |
| $0.47\mu F$ | 94ms     |
| $1.0\mu F$  | 200ms    |

### DOCKING STATION

Applications such as notebook computers can take advantage of a docking station to connect to external devices such as monitors or audio/visual equipment that sends or receives line level signals. The LM4839 has two outputs, Right Dock and Left Dock which connect to outputs of the internal input amplifiers that drive the volume control inputs. These input amplifiers can drive loads of  $>1k\Omega$  (such as powered speakers) with a rail-to-rail signal. Since the output signal present on the RIGHT DOCK and LEFT DOCK pins is biased to  $V_{DD}/2$ , coupling capacitors should be connected in series with the load. Typical values for the coupling capacitors are  $0.33\mu F$  to  $1.0\mu F$ . If polarized coupling capacitors are used, connect their "+" terminals to the respective output pin.

Since the DOCK outputs precede the internal volume control, the signal amplitude will be equal to the input signal's magnitude and cannot be adjusted. However, the input amplifier's closed-loop gain can be adjusted using external resistors.

These 20K resistors are shown in Figure 1 ( $R_{IN}, R_F$ ) and they set each input amplifier's gain to  $-1$ . Use Equation 8 to determine the input and feedback resistor values for a desired gain.

$$-A_v = R_F / R_i \quad (8)$$

Adjusting the input amplifier's gain sets the minimum gain for that channel. Although the single ended outputs of the Bridge Output Amplifiers can be used to drive line level outputs, it is recommended that the R & L Dock Outputs simpler signal path be used for better performance.

### STEREO-INPUT MULTIPLEXER (STEREO MUX)

The LM4839 has two stereo inputs. The MUX CONTROL pin controls which stereo input is active. Applying 0V to the MUX CONTROL pin selects stereo input 1. Applying  $V_{DD}$  to the MUX CONTROL pin selects stereo input 2.

### BEEP DETECT FUNCTION

Computers and notebooks produce a system "beep" signal that drives a small speaker. The speaker's auditory output signifies that the system requires user attention or input. To accommodate this system alert signal, the LM4839's beep input pin is a mono input that accepts the beep signal. Internal level detection circuitry at this input monitors the beep signal's magnitude. When a signal level greater than  $V_{DD}/2$  is detected on the BEEP IN pin, the bridge output amplifiers are enabled. The beep signal is amplified and applied to the load connected to the output amplifiers. A valid beep signal will be applied to the load even when MUTE is active. Use the input resistors connected between the BEEP IN pin and the stereo input pins to accommodate different beep signal amplitudes. These resistors are shown as  $200k\Omega$  devices in Figure 1. Use higher value resistors to reduce the gain applied to the beep signal. The resistors must be used to pass the beep signal to the stereo inputs. The BEEP IN pin is used only to detect the beep signal's magnitude: it does not pass the signal to the output amplifiers. The LM4839's shutdown mode must be deactivated before a system alert signal is applied to the BEEP IN pin.

### MICRO-POWER SHUTDOWN

The voltage applied to the SHUTDOWN pin controls the LM4839's shutdown function. Activate micro-power shutdown by applying  $V_{DD}$  to the SHUTDOWN pin. When active, the LM4839's micro-power shutdown feature turns off the amplifier's bias circuitry, reducing the supply current. The logic threshold is typically  $V_{DD}/2$ . The low  $0.7\mu A$  typical shutdown current is achieved by applying a voltage that is as near as  $V_{DD}$  as possible, to the SHUTDOWN pin. A voltage that is less than  $V_{DD}$  may increase the shutdown current. Logic Level Truth Table shows the logic signal levels that activate and deactivate micro-power shutdown and headphone amplifier operation.

There are a few ways to control the micro-power shutdown. These include using a single-pole, single-throw switch, a microprocessor, or a microcontroller. When using a switch, connect an external  $10k\Omega$  pull-up resistor between the SHUTDOWN pin and  $V_{DD}$ . Connect the switch between the SHUTDOWN pin and ground. Select normal amplifier operation by closing the switch. Opening the switch connects the SHUTDOWN pin to  $V_{DD}$  through the pull-up resistor, activating micro-power shutdown. The switch and resistor guarantee that the SHUTDOWN pin will not float. This prevents unwanted state changes. In a system with a microprocessor or a microcontroller, use a digital output to apply the control volt-



age to the SHUTDOWN pin. Driving the SHUTDOWN pin with active circuitry eliminates the need for a pull up resistor.

**TABLE 1. Logic Level Truth Table for SHUTDOWN, HP-IN, and MUX Operation**

| SHUTDOWN PIN | HP-IN PIN  | MUX CHANNEL SELECT PIN | OPERATIONAL MODE (MUX INPUT CHANNEL #) |
|--------------|------------|------------------------|--|
| Logic Low    | Logic Low  | Logic Low              | Bridged Amplifiers (1)                 |
| Logic Low    | Logic Low  | Logic High             | Bridged Amplifiers (2)                 |
| Logic Low    | Logic High | Logic Low              | Single-Ended Amplifiers (1)            |
| Logic Low    | Logic High | Logic High             | Single-Ended Amplifiers (2)            |
| Logic High   | X          | X                      | Micro-Power Shutdown                   |

### MUTE FUNCTION

The LM4839 mutes the amplifier and DOCK outputs when  $V_{DD}$  is applied to pin 5, the MUTE pin. Even while muted, the LM4839 will amplify a system alert (beep) signal whose magnitude satisfies the BEEP DETECT circuitry. Applying 0V to the MUTE pin returns the LM4839 to normal, unmuted operation. Prevent unanticipated mute behavior by connecting the MUTE pin to  $V_{DD}$  or ground. Do not let the mute pin float.

### HP SENSE FUNCTION ( Head Phone In )

Applying a voltage between 4V and  $V_{DD}$  to the LM4839's HP-IN headphone control pin turns off the amps that drive the left out "+" and right out "+" pins. ( Pins 15 and 20 on the MT/MTE & 12 and 25 on the LQ ). This action mutes a bridged-connected load. Quiescent current consumption is reduced when the IC is in this single-ended mode.

Figure 2 shows the implementation of the LM4839's headphone control function. With no headphones connected to the headphone jack, the R1-R2 voltage divider sets the voltage applied to the HP Sense pin at approximately 50mV. This 50mV puts the LM4839 into bridged mode operation. The output coupling capacitor blocks the amplifier's half supply DC voltage, protecting the headphones.

The HP-IN threshold is set at 4V. While the LM4839 operates in bridged mode, the DC potential across the load is essentially 0V. Therefore, even in an ideal situation, the output swing cannot cause a false single-ended trigger. Connecting headphones to the headphone jack disconnects the headphone jack contact pin from R2 and allows R1 to pull the HP Sense pin up to  $V_{DD}$  through R4. This enables the headphone function, turns off both of the "+" output amplifiers and mutes the bridged speaker. The amplifier then drives the headphones, whose impedance is in parallel with resistors R2 and R3. These resistors have negligible effect on the LM4839's output drive capability since the typical impedance of headphones is 32Ω.

Figure 2 also shows the suggested headphone jack electrical connections. The jack is designed to mate with a three-wire plug. The plug's tip and ring should each carry one of the two stereo output signals, whereas the sleeve should carry the ground return. A headphone jack with one control pin contact is sufficient to drive the HP-IN pin when connecting headphones.

A microprocessor or a switch can replace the headphone jack contact pin. When a microprocessor or switch applies a voltage greater than 4V to the HP-IN pin, a bridge-connected speaker is muted and the single ended output amplifiers A1 and A2 will drive a pair of headphones.

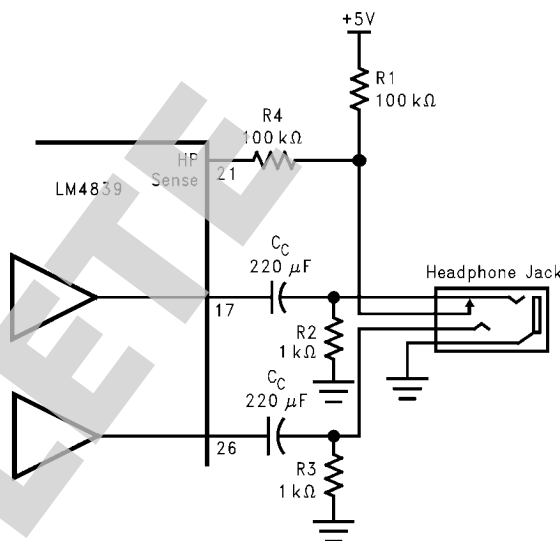

20013404

**FIGURE 2. Headphone Sensing Circuit (MT/MTE Pinout)**

### BASS BOOST FUNCTION

The Bass Boost Function can be toggled by changing the logic at the Bass Boost Select pin. A logic low will switch the power amplifiers to bass boost mode. In bass boost mode, the low frequency gain of the amplifier is set by the external CBS capacitor in Figure 1. Where as a logic high sets the amplifiers to unity gain.

In some cases, a designer may want to improve the low frequency response of the bridged amplifier or incorporate a bass boost feature. This bass boost can be useful in systems where speakers are housed in small enclosures. If the designer wishes to disable the bass boost feature, pin 19 ( MT/ MTE packages ) can be tied to  $V_{DD}$ .

When the bass boost is enabled, the output amplifiers will be internally set at a gain of 2 at low frequencies (gain of 4 in bridged mode). As shown in Figure 1, CBS sets the cutoff frequency for the bass boost. At low frequencies, the capacitor will be virtually an open circuit. At high frequencies, the capacitor will be virtually a short circuit. As a result of this, the gain of the bridge amplifier is increased as low frequencies. A first order pole is formed with a corner frequency at:

$$f_c = 1/(2\pi 10k\Omega CBS) \quad (9)$$

With CBS = 0.1μF, a first order pole is formed with a corner frequency of 160Hz.

### DC VOLUME CONTROL

The LM4839 has an internal stereo volume control whose setting is a function of the DC voltage applied to the DC VOL CONTROL pin.

The LM4839 volume control consists of 31 steps that are individually selected by a variable DC voltage level on the volume control pin. The range of the steps, controlled by the DC voltage, are from 0dB - 78dB. Each gain step corresponds to a specific input voltage range, as shown in table 2.

To minimize the effect of noise on the volume control pin, which can affect the selected gain level, hysteresis has been implemented. The amount of hysteresis corresponds to half

of the step width, as shown in Volume Control Characterization Graph (DS200133-40).

For highest accuracy, the voltage shown in the 'recommended voltage' column of the table is used to select a desired gain. This recommended voltage is exactly halfway between the two nearest transitions to the next highest or next lowest gain levels.

The gain levels are 1dB/step from 0dB to -6dB, 2dB/step from -6dB to -36dB, 3dB/step from -36dB to -47dB, 4dB/step from -47dB to -51dB, 5dB/step from -51dB to -66dB, and 12dB to the last step at -78dB.

OBSOLETE

Volume Control Table ( Table 2 )

| Gain (dB) | Voltage Range (% of Vdd) |         |             | Voltage Range (Vdd = 5) |       |             | Voltage Range (Vdd = 3) |       |             |
|-----------|--------------------------|---------|-------------|-------------------------|-------|-------------|-------------------------|-------|-------------|
|           | Low                      | High    | Recommended | Low                     | High  | Recommended | Low                     | High  | Recommended |
| 0         | 77.5%                    | 100.00% | 100.000%    | 3.875                   | 5.000 | 5.000       | 2.325                   | 3.000 | 3.000       |
| -1        | 75.0%                    | 78.5%   | 76.875%     | 3.750                   | 3.938 | 3.844       | 2.250                   | 2.363 | 2.306       |
| -2        | 72.5%                    | 76.25%  | 74.375%     | 3.625                   | 3.813 | 3.719       | 2.175                   | 2.288 | 2.231       |
| -3        | 70.0%                    | 73.75%  | 71.875%     | 3.500                   | 3.688 | 3.594       | 2.100                   | 2.213 | 2.156       |
| -4        | 67.5%                    | 71.25%  | 69.375%     | 3.375                   | 3.563 | 3.469       | 2.025                   | 2.138 | 2.081       |
| -5        | 65.0%                    | 68.75%  | 66.875%     | 3.250                   | 3.438 | 3.344       | 1.950                   | 2.063 | 2.006       |
| -6        | 62.5%                    | 66.25%  | 64.375%     | 3.125                   | 3.313 | 3.219       | 1.875                   | 1.988 | 1.931       |
| -8        | 60.0%                    | 63.75%  | 61.875%     | 3.000                   | 3.188 | 3.094       | 1.800                   | 1.913 | 1.856       |
| -10       | 57.5%                    | 61.25%  | 59.375%     | 2.875                   | 3.063 | 2.969       | 1.725                   | 1.838 | 1.781       |
| -12       | 55.0%                    | 58.75%  | 56.875%     | 2.750                   | 2.938 | 2.844       | 1.650                   | 1.763 | 1.706       |
| -14       | 52.5%                    | 56.25%  | 54.375%     | 2.625                   | 2.813 | 2.719       | 1.575                   | 1.688 | 1.631       |
| -16       | 50.0%                    | 53.75%  | 51.875%     | 2.500                   | 2.688 | 2.594       | 1.500                   | 1.613 | 1.556       |
| -18       | 47.5%                    | 51.25%  | 49.375%     | 2.375                   | 2.563 | 2.469       | 1.425                   | 1.538 | 1.481       |
| -20       | 45.0%                    | 48.75%  | 46.875%     | 2.250                   | 2.438 | 2.344       | 1.350                   | 1.463 | 1.406       |
| -22       | 42.5%                    | 46.25%  | 44.375%     | 2.125                   | 2.313 | 2.219       | 1.275                   | 1.388 | 1.331       |
| -24       | 40.0%                    | 43.75%  | 41.875%     | 2.000                   | 2.188 | 2.094       | 1.200                   | 1.313 | 1.256       |
| -26       | 37.5%                    | 41.25%  | 39.375%     | 1.875                   | 2.063 | 1.969       | 1.125                   | 1.238 | 1.181       |
| -28       | 35.0%                    | 38.75%  | 36.875%     | 1.750                   | 1.938 | 1.844       | 1.050                   | 1.163 | 1.106       |
| -30       | 32.5%                    | 36.25%  | 34.375%     | 1.625                   | 1.813 | 1.719       | 0.975                   | 1.088 | 1.031       |
| -32       | 30.0%                    | 33.75%  | 31.875%     | 1.500                   | 1.688 | 1.594       | 0.900                   | 1.013 | 0.956       |
| -34       | 27.5%                    | 31.25%  | 29.375%     | 1.375                   | 1.563 | 1.469       | 0.825                   | 0.937 | 0.881       |
| -36       | 25.0%                    | 28.75%  | 26.875%     | 1.250                   | 1.438 | 1.344       | 0.750                   | 0.862 | 0.806       |
| -39       | 22.5%                    | 26.25%  | 24.375%     | 1.125                   | 1.313 | 1.219       | 0.675                   | 0.787 | 0.731       |
| -42       | 20.0%                    | 23.75%  | 21.875%     | 1.000                   | 1.188 | 1.094       | 0.600                   | 0.712 | 0.656       |
| -45       | 17.5%                    | 21.25%  | 19.375%     | 0.875                   | 1.063 | 0.969       | 0.525                   | 0.637 | 0.581       |
| -47       | 15.0%                    | 18.75%  | 16.875%     | 0.750                   | 0.937 | 0.844       | 0.450                   | 0.562 | 0.506       |
| -51       | 12.5%                    | 16.25%  | 14.375%     | 0.625                   | 0.812 | 0.719       | 0.375                   | 0.487 | 0.431       |
| -56       | 10.0%                    | 13.75%  | 11.875%     | 0.500                   | 0.687 | 0.594       | 0.300                   | 0.412 | 0.356       |
| -61       | 7.5%                     | 11.25%  | 9.375%      | 0.375                   | 0.562 | 0.469       | 0.225                   | 0.337 | 0.281       |
| -66       | 5.0%                     | 8.75%   | 6.875%      | 0.250                   | 0.437 | 0.344       | 0.150                   | 0.262 | 0.206       |
| -78       | 0.0%                     | 6.25%   | 0.000%      | 0.000                   | 0.312 | 0.000       | 0.000                   | 0.187 | 0.000       |



## Audio Power Amplifier Design

### Audio Amplifier Design: Driving 1W into an 8Ω Load

The following are the desired operational parameters:

|                  |                         |
|------------------|-------------------------|
| Power Output:    | 1 W <sub>RMS</sub>      |
| Load Impedance:  | 8Ω                      |
| Input Level:     | 1 V <sub>RMS</sub>      |
| Input Impedance: | 20 kΩ                   |
| Bandwidth:       | 100 Hz–20 kHz ± 0.25 dB |

The design begins by specifying the minimum supply voltage necessary to obtain the specified output power. One way to find the minimum supply voltage is to use the Output Power vs Supply Voltage curve in the **Typical Performance Characteristics** section. Another way, using Equation (11), is to calculate the peak output voltage necessary to achieve the desired output power for a given load impedance. To account for the amplifier's dropout voltage, two additional voltages, based on the Dropout Voltage vs Supply Voltage in the **Typical Performance Characteristics** curves, must be added to the result obtained by Equation (11). The result is Equation (12).

$$V_{\text{outpeak}} = \sqrt{(2R_L P_O)} \quad (10)$$

$$V_{DD} \geq (V_{\text{OUTPEAK}} + (V_{\text{ODTOP}} + V_{\text{ODBOT}})) \quad (11)$$

The Output Power vs Supply Voltage graph for an 8Ω load indicates a minimum supply voltage of 4.6V. This is easily met by the commonly used 5V supply voltage. The additional voltage creates the benefit of headroom, allowing the LM4839 to produce peak output power in excess of 1W without clipping or other audible distortion. The choice of supply voltage must also not create a situation that violates of maximum power dissipation as explained above in the **Power Dissipation** section.

After satisfying the LM4839's power dissipation requirements, the minimum differential gain needed to achieve 1W dissipation in an 8Ω load is found using Equation (13).

$$A_{VD} \geq \sqrt{(P_O R_L)} / (V_{IN}) = V_{\text{orms}} / V_{\text{inrms}} \quad (12)$$

Thus, a minimum overall gain of 2.83 allows the LM4839's to reach full output swing and maintain low noise and THD+N performance.

The last step in this design example is setting the amplifier's –3dB frequency bandwidth. To achieve the desired ±0.25dB

pass band magnitude variation limit, the low frequency response must extend to at least one-fifth the lower bandwidth limit and the high frequency response must extend to at least five times the upper bandwidth limit. The gain variation for both response limits is 0.17dB, well within the ±0.25dB desired limit. The results are an

$$f_L = 100\text{Hz}/5 = 20\text{Hz} \quad (13)$$

and an

$$f_H = 20\text{kHz} \times 5 = 100\text{kHz} \quad (14)$$

As mentioned in the **Selecting Proper External Components** section, R<sub>i</sub> (Right & Left) and C<sub>i</sub> (Right & Left) create a highpass filter that sets the amplifier's lower bandpass frequency limit. Find the coupling capacitor's value using Equation (17).

$$C_i \geq 1/(2\pi R_i f_L) \quad (15)$$

The result is

$$1/(2\pi * 20\text{k}\Omega * 20\text{Hz}) = 0.397\mu\text{F} \quad (16)$$

Use a 0.39μF capacitor, the closest standard value.

The product of the desired high frequency cutoff (100kHz in this example) and the differential gain A<sub>VD</sub>, determines the upper passband response limit. With A<sub>VD</sub> = 3 and f<sub>H</sub> = 100kHz, the closed-loop gain bandwidth product (GBWP) is 300kHz. This is less than the LM4839's 3.5MHz GBWP. With this margin, the amplifier can be used in designs that require more differential gain while avoiding performance, restricting bandwidth limitations.

## Recommended Printed Circuit Board Layout

Figures 4 through 8 show the recommended four-layer PC board layout that is optimized for the 8-pin LQ-packaged LM4839 and associated external components. This circuit is designed for use with an external 5V supply and 4Ω speakers.

This circuit board is easy to use. Apply 5V and ground to the board's V<sub>DD</sub> and GND pads, respectively. Connect 4Ω speakers between the board's –OUTA and +OUTA and OUTB and +OUTB pads.

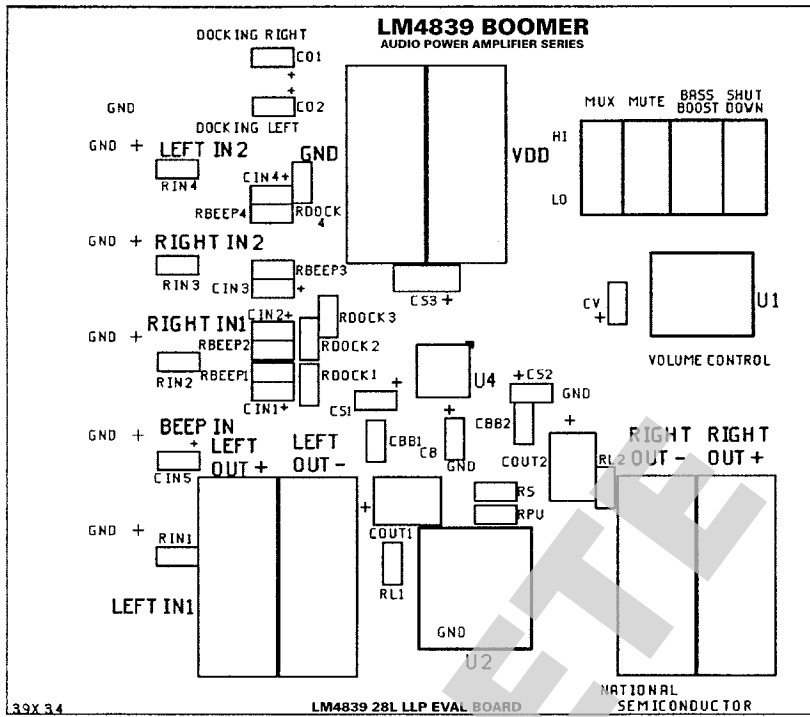

33X 34 LM4839 28L LLP EVAL BOARD NATIONAL SEMICONDUCTOR 20013478

FIGURE 3. Recommended LQ PC Board Layout:Component-Side Silkscreen

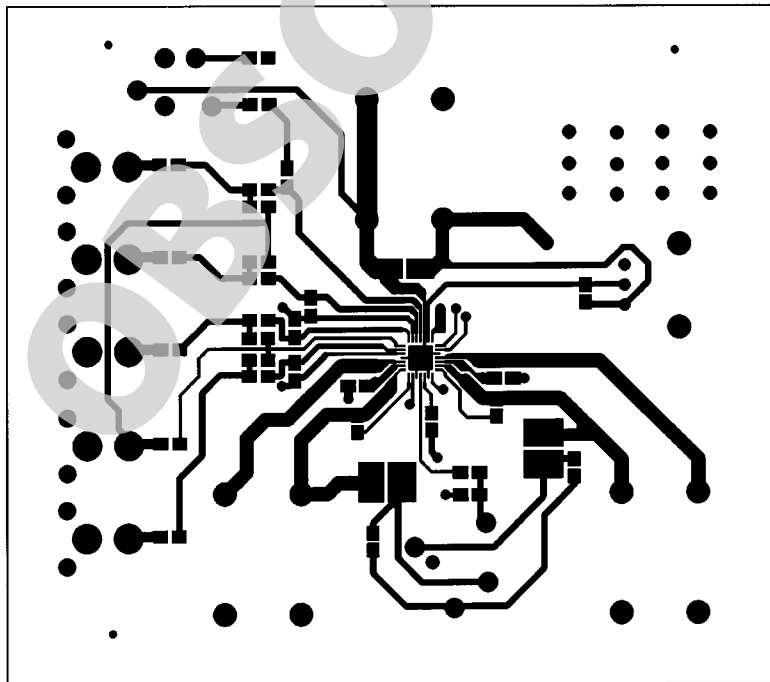

20013479

FIGURE 4. Recommended LQ PC Board Layout:Component-Side Layout

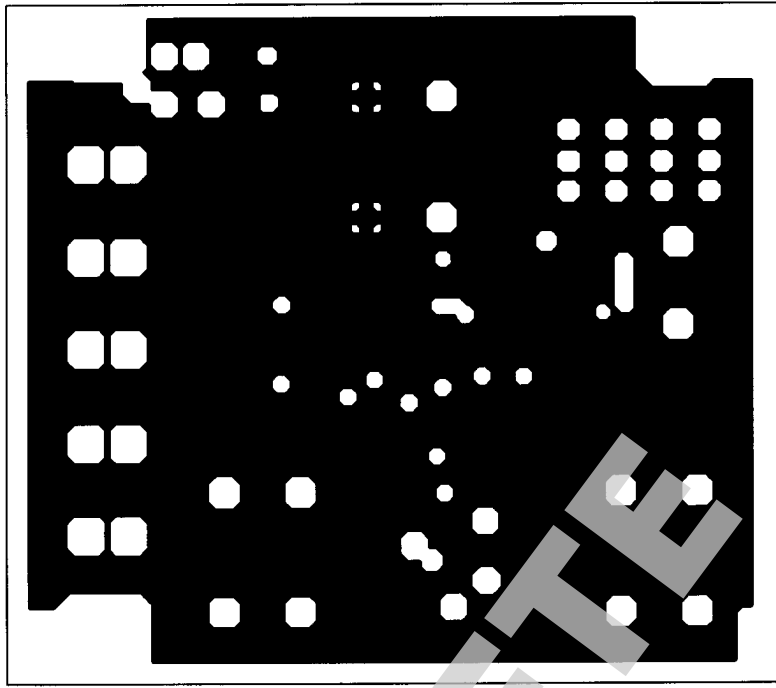

20013480

**FIGURE 5. Recommended LQ PC Board Layout:  
Upper Inner-Layer Layout**

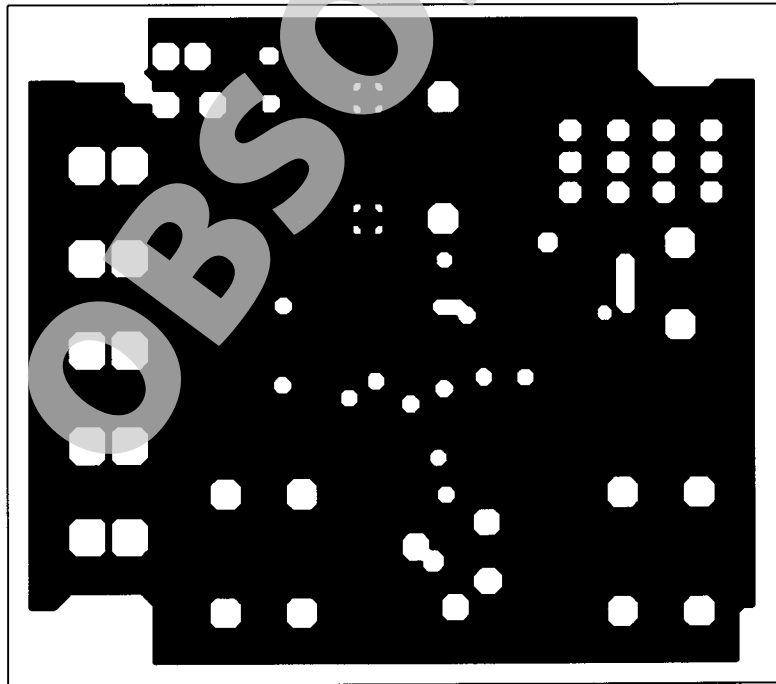

20013481

**FIGURE 6. Recommended LQ PC Board Layout:  
Lower Inner-Layer Layout**

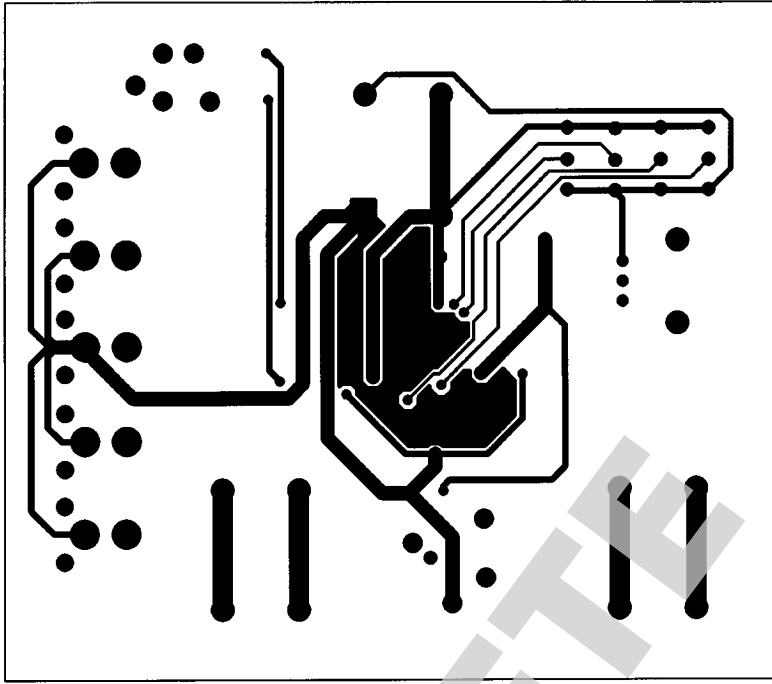

20013482

**FIGURE 7. Recommended LQ PC Board Layout:  
Bottom-Side Layout**

OBSOLETE

**Analog Audio LM4839 LLP28 Eval Board (LQ Package)**  
**Assembly Part Number: 980011368-100**  
**Revision: A1**  
**Bill of Material**

| Item | Part Number   | Part Description                            | Qty | Ref Designator  | Remark                |
|------|---------------|---|-----|---|-----------------------|
| 1    | 551011368-001 | LM4838 Eval Board PCB etch 001              | 1   |   |                       |
| 10   | 482911368-001 | LM4838 28L LLP                              | 1   | U4  |                       |
| 20   | 151911368-001 | Cer Cap 0.068 $\mu$ F 50V 10% 1206          | 2   | CBB1, CBB2  |                       |
| 25   | 152911368-001 | Tant Cap 0.1 $\mu$ F 10V 10% Size = A 3216  | 3   | CS1, CS2, CV  |                       |
| 26   | 152911368-002 | Tant Cap 0.33 $\mu$ F 10V 10% Size = A 3216 | 5   | Cin1, Cin2, Cin3, Cin4, (Cin5 - CBEEPIN- not seen on Fig 1, only exists on LQ Demo Board) |                       |
| 27   | 152911368-003 | Tant Cap 1 $\mu$ F 16V 10% Size = A 3216    | 3   | CB, C01, C02  |                       |
| 28   | 152911368-004 | Tant Cap 10 $\mu$ F 10V 10% Size = C 6032   | 1   | CS3   |                       |
| 29   | 152911368-005 | Tant Cap 220 $\mu$ F 16V 10% Size = D 7343  | 2   | Cout1, Cout2  |                       |
| 30   | 472911368-001 | Res 150Ohm 1/8W 1% 1206                     | 2   | RL1, RL2  |                       |
| 31   | 472911368-002 | Res 20k Ohm 1/8W 1% 1206                    | 10  | Rin1, Rin2, RF1, RF2<br>RI1, RI2, RBS1, RBS2<br>Rdock1, Rdock2                            |                       |
| 32   | 472911368-003 | Res 100k Ohm 1/8W 1% 1206                   | 2   | RS, RPU   |                       |
| 33   | 472911368-004 | Res 200k Ohm 1/16W 1% 0603                  | 2   | Rbeep1, Rbeep2  |                       |
| 40   | 131911368-001 | Stereo Headphone Jack W/ Switch             | 1   | U2  | Mouser # 161-3500     |
| 41   | 131911368-002 | Slide Switch                                | 4   | Mode, Mute, Gain, SD  | Mouser # 10SP003      |
| 42   | 131911368-003 | Potentiometer                               | 1   | U1  | Mouser # 317-290-100K |
| 43   | 131911368-004 | RCA Jack                                    | 3   | RightIn, BeepIn, LeftIn   | Mouser # 16PJ097      |
| 44   | 131911368-005 | Banana Jack, Black                          | 3   | GND, Right Out-, Left Out-  | Mouser # ME164-6219   |
| 45   | 131911368-006 | Banana Jack, Red                            | 3   | Vdd, Right Out+, Left Out+  | Mouser # ME164-6218   |
|      |               |   |     |   |                       |

# Recommended Printed Circuit Board Layout - MT/MTE Packages

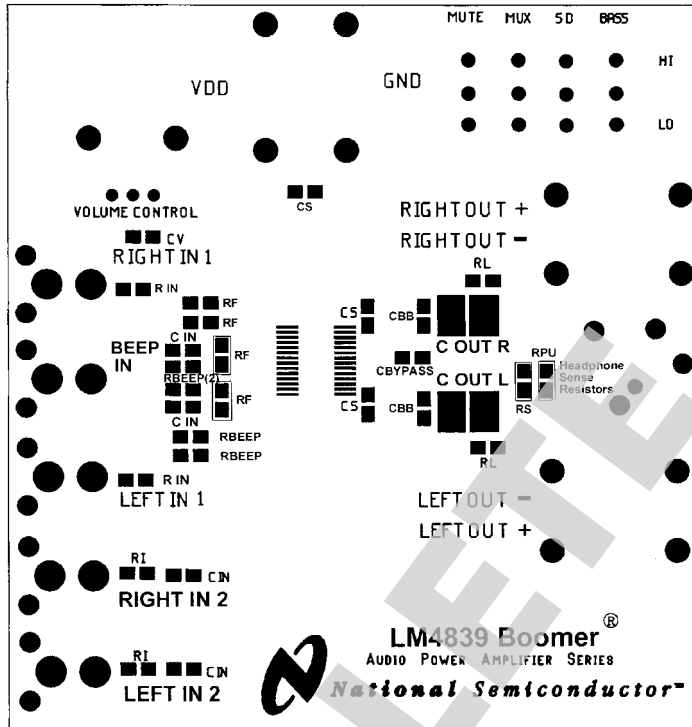

Top Layer SilkScreen + Pad - ( Not to Scale )

20013484

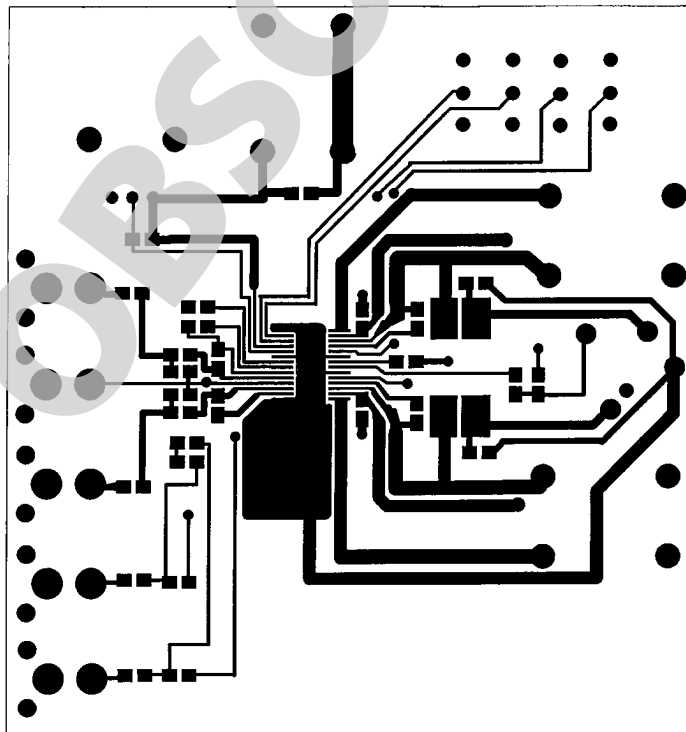

Top Layer - ( Not to Scale )

20013485

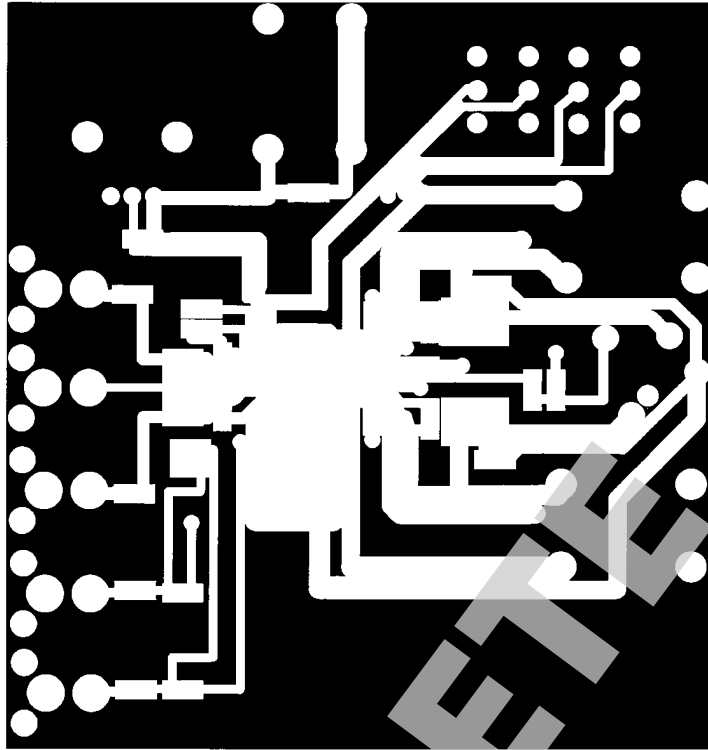

Layer 2 - ( Not to Scale )

20013486

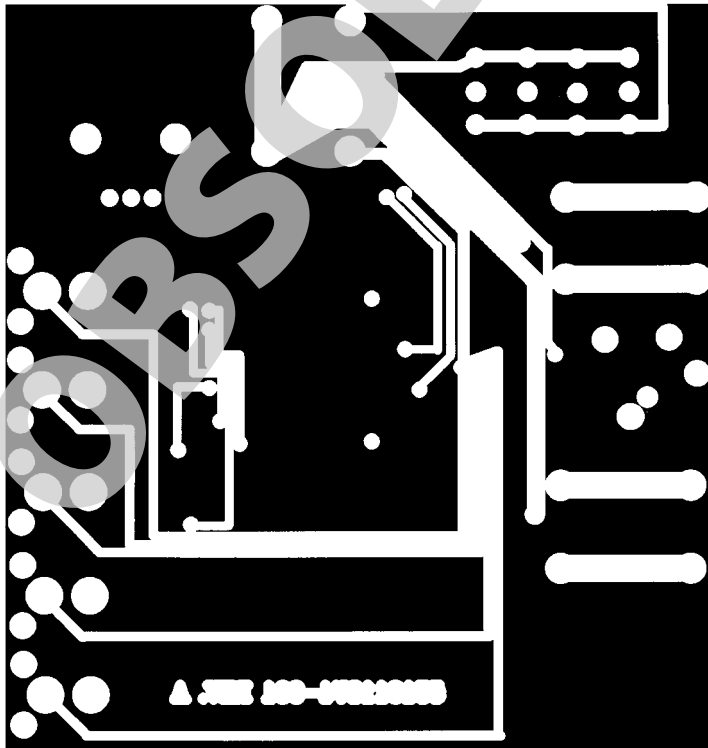

Layer 3 - ( Not to scale )

20013487

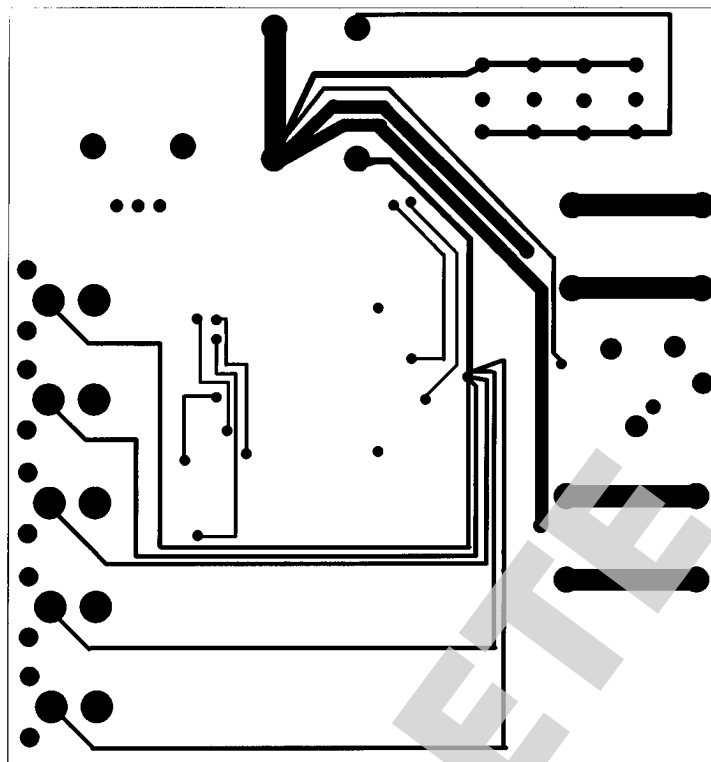

20013488

Bottom Layer - ( Not to scale )

Analog Audio LM4839 MSOP Eval Board  
 Assembly Part Number: 980011373-100  
 Revision: A  
 Bill of Material

| Item | Part Number   | Part Description                            | Qty | Ref Designator (on PCB) | Remark                 |
|------|---------------|---|-----|-------------------------|------------------------|
| 1    | 551011373-001 | LM4839 Eval Board PCB etch 001              | 1   |                         |                        |
| 10   | 482911373-001 | LM4839 MSOP                                 | 1   |                         |                        |
| 20   | 151911368-001 | Cer Cap 0.068 $\mu$ F 50V 10% 1206          | 2   | CBB (2)                 |                        |
| 25   | 152911368-001 | Tant Cap 0.1 $\mu$ F 10V 10% Size = A 3216  | 2   | CS (2)                  |                        |
| 26   | 152911368-002 | Tant Cap 0.33 $\mu$ F 10V 10% Size = A 3216 | 4   | CIN (4)                 |                        |
| 27   | 152911368-003 | Tant Cap 1 $\mu$ F 16V 10% Size = A 3216    | 1   | CBYPASS                 |                        |
| 28   | 152911368-004 | Tant Cap 10 $\mu$ F 10V 10% Size = C 6032   | 1   | CS1                     |                        |
| 29   | 152911368-005 | Tant Cap 220 $\mu$ F 16V 10% Size = D 7343  | 2   | COUT R, COUT L          |                        |
| 30   | 472911368-001 | Res 1K $\Omega$ 1/8W 1% 1206                | 2   | RL (2)                  |                        |
| 31   | 472911368-002 | Res 20K Ohm 1/8W 1% 1206                    | 8   | RIN, RF                 |                        |
| 32   | 472911368-003 | Res 100K Ohm 1/8W 1% 1206                   | 2   | R5, RPU                 |                        |
| 33   | 472911368-004 | Res 200K Ohm 1/16W 1% 0603                  | 4   | RBEEP (R)               |                        |
| 40   | 131911368-001 | Stereo Headphone Jack W/ Switch             | 1   |                         | Mouser # 161-3500      |
| 41   | 131911368-002 | Slide Switch                                | 4   | mute, max,SD, BASS      | Mouser # 10SP003       |
| 42   | 131911368-003 | Potentiometer                               | 1   | Volume Control          | Mouser # 317-2090-100K |
| 43   | 131911368-004 | RCA Jack                                    | 5   |                         | Mouser # 16PJ097       |
| 44   | 131911368-005 | Banana Jack, Black                          | 3   |                         | Mouser # ME164-6219    |
| 45   | 131911368-006 | Banana Jack, Red                            | 3   |                         | Mouser # ME164-6218    |
|      |               |   |     |                         |                        |



**Physical Dimensions** inches (millimeters) unless otherwise noted

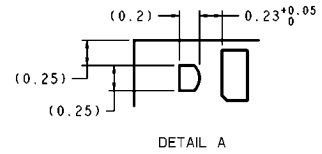
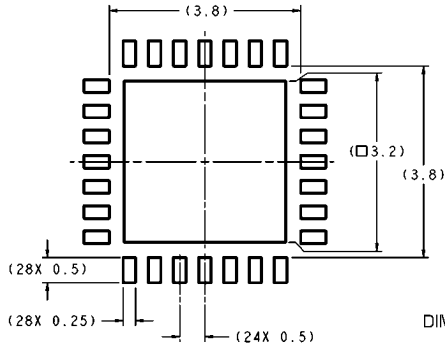

DIMENSIONS ARE IN MILLIMETERS

RECOMMENDED LAND PATTERN  
1:1 RATION WITH PKG SOLDER PADS

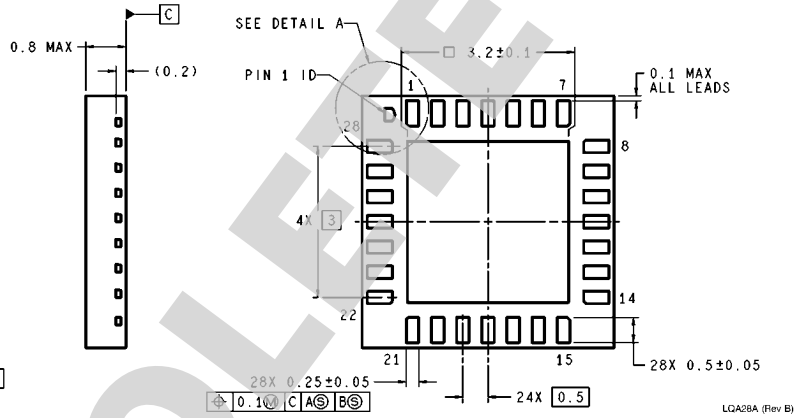
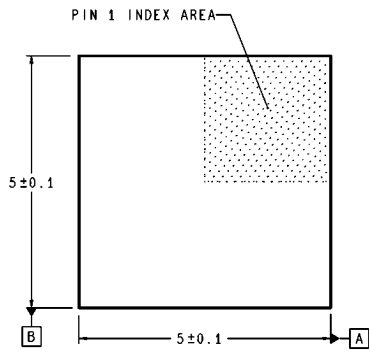

**LLP Package**  
Order Number **LM4839LQ**  
**NS Package Number LQA028AA For Exposed-DAP LLP**

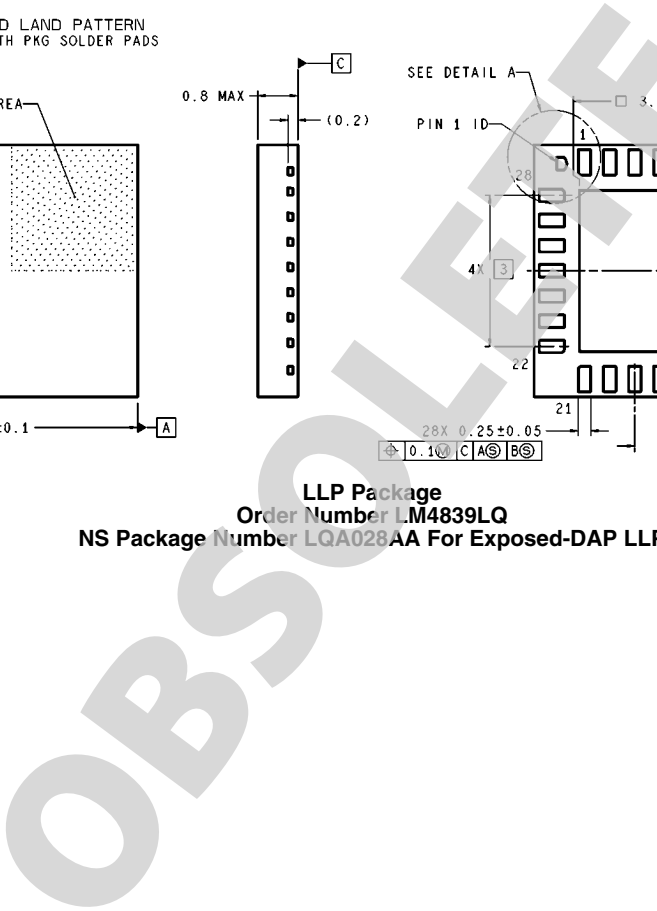

LQA28A (Rev B)

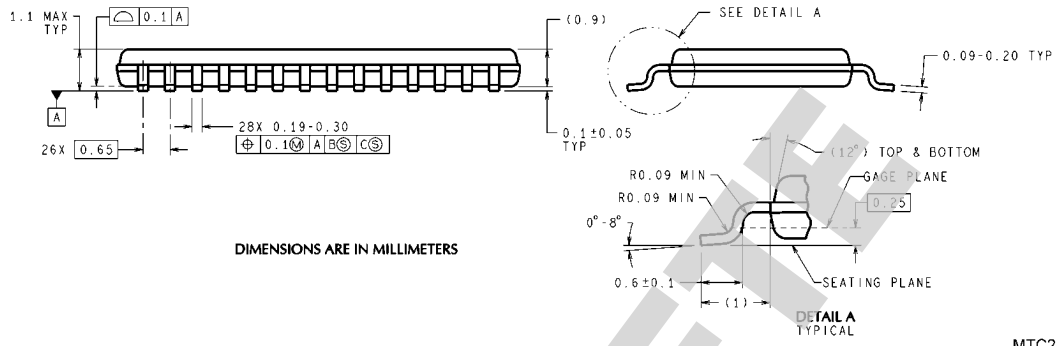
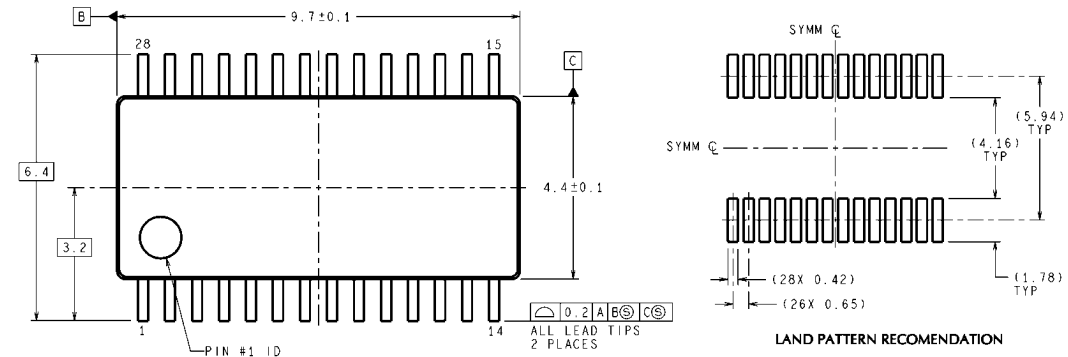

DIMENSIONS ARE IN MILLIMETERS

**TSSOP Package**  
**Order Number LM4839MT**  
**NS Package Number MTC28 for TSSOP**

MTC28 (Rev D)

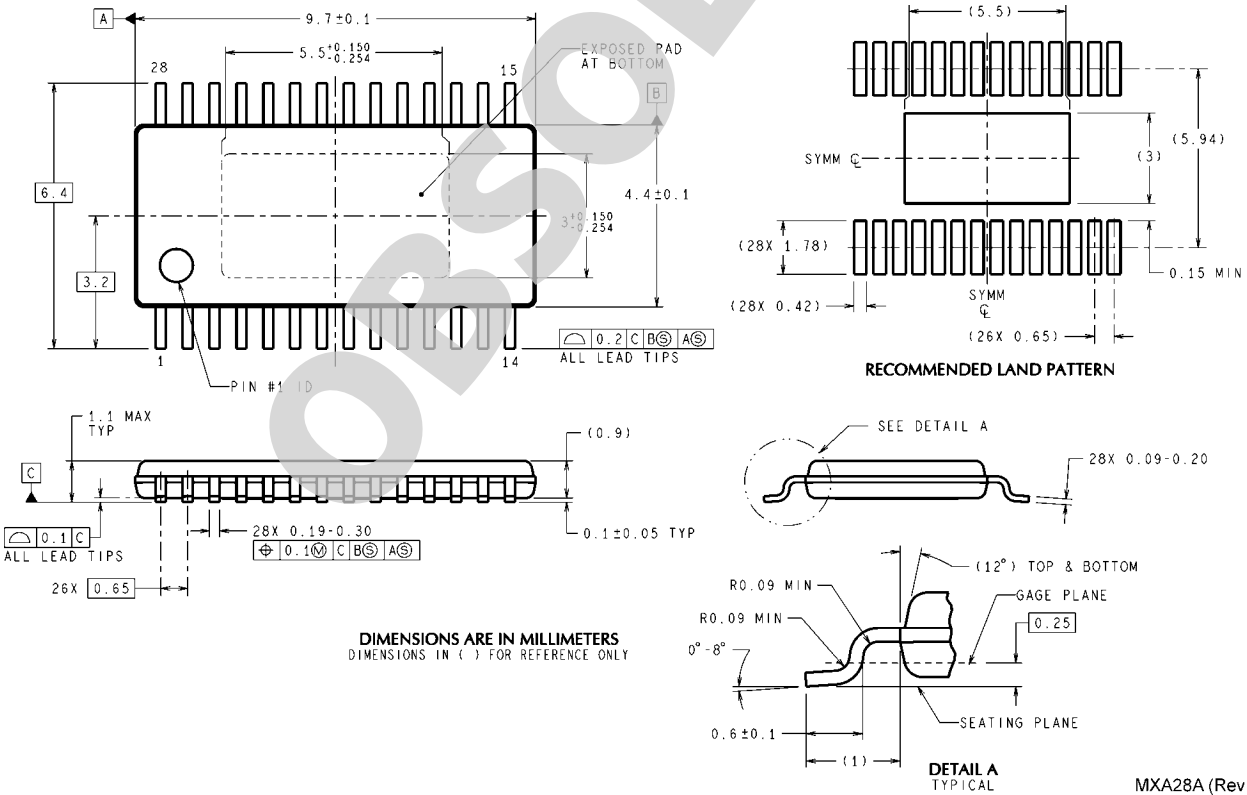

DIMENSIONS ARE IN MILLIMETERS  
 DIMENSIONS IN ( ) FOR REFERENCE ONLY

**Exposed-DAP TSSOP Package**  
**Order Number LM4839MTE**  
**NS Package Number MXA28A for Exposed-DAP TSSOP**

MXA28A (Rev D)

## Notes

For more National Semiconductor product information and proven design tools, visit the following Web sites at:  
[www.national.com](http://www.national.com)

| Products                       |  | Design Support               |  |
|--------------------------------|--|------------------------------|--|
| Amplifiers                     | <a href="http://www.national.com/amplifiers">www.national.com/amplifiers</a> | WEBENCH® Tools               | <a href="http://www.national.com/webench">www.national.com/webench</a>             |
| Audio                          | <a href="http://www.national.com/audio">www.national.com/audio</a>           | App Notes                    | <a href="http://www.national.com/appnotes">www.national.com/appnotes</a>           |
| Clock and Timing               | <a href="http://www.national.com/timing">www.national.com/timing</a>         | Reference Designs            | <a href="http://www.national.com/refdesigns">www.national.com/refdesigns</a>       |
| Data Converters                | <a href="http://www.national.com/adc">www.national.com/adc</a>               | Samples                      | <a href="http://www.national.com/samples">www.national.com/samples</a>             |
| Interface                      | <a href="http://www.national.com/interface">www.national.com/interface</a>   | Eval Boards                  | <a href="http://www.national.com/evalboards">www.national.com/evalboards</a>       |
| LVDS                           | <a href="http://www.national.com/lvds">www.national.com/lvds</a>             | Packaging                    | <a href="http://www.national.com/packaging">www.national.com/packaging</a>         |
| Power Management               | <a href="http://www.national.com/power">www.national.com/power</a>           | Green Compliance             | <a href="http://www.national.com/quality/green">www.national.com/quality/green</a> |
| Switching Regulators           | <a href="http://www.national.com/switchers">www.national.com/switchers</a>   | Distributors                 | <a href="http://www.national.com/contacts">www.national.com/contacts</a>           |
| LDOs                           | <a href="http://www.national.com/ldo">www.national.com/ldo</a>               | Quality and Reliability      | <a href="http://www.national.com/quality">www.national.com/quality</a>             |
| LED Lighting                   | <a href="http://www.national.com/led">www.national.com/led</a>               | Feedback/Support             | <a href="http://www.national.com/feedback">www.national.com/feedback</a>           |
| Voltage References             | <a href="http://www.national.com/vref">www.national.com/vref</a>             | Design Made Easy             | <a href="http://www.national.com/easy">www.national.com/easy</a>                   |
| PowerWise® Solutions           | <a href="http://www.national.com/powerwise">www.national.com/powerwise</a>   | Applications & Markets       | <a href="http://www.national.com/solutions">www.national.com/solutions</a>         |
| Serial Digital Interface (SDI) | <a href="http://www.national.com/sdi">www.national.com/sdi</a>               | Mil/Aero                     | <a href="http://www.national.com/milaero">www.national.com/milaero</a>             |
| Temperature Sensors            | <a href="http://www.national.com/tempensors">www.national.com/tempensors</a> | SolarMagic™                  | <a href="http://www.national.com/solarmagic">www.national.com/solarmagic</a>       |
| PLL/VCO                        | <a href="http://www.national.com/wireless">www.national.com/wireless</a>     | PowerWise® Design University | <a href="http://www.national.com/training">www.national.com/training</a>           |

THE CONTENTS OF THIS DOCUMENT ARE PROVIDED IN CONNECTION WITH NATIONAL SEMICONDUCTOR CORPORATION ("NATIONAL") PRODUCTS. NATIONAL MAKES NO REPRESENTATIONS OR WARRANTIES WITH RESPECT TO THE ACCURACY OR COMPLETENESS OF THE CONTENTS OF THIS PUBLICATION AND RESERVES THE RIGHT TO MAKE CHANGES TO SPECIFICATIONS AND PRODUCT DESCRIPTIONS AT ANY TIME WITHOUT NOTICE. NO LICENSE, WHETHER EXPRESS, IMPLIED, ARISING BY ESTOPPEL OR OTHERWISE, TO ANY INTELLECTUAL PROPERTY RIGHTS IS GRANTED BY THIS DOCUMENT.

TESTING AND OTHER QUALITY CONTROLS ARE USED TO THE EXTENT NATIONAL DEEMS NECESSARY TO SUPPORT NATIONAL'S PRODUCT WARRANTY. EXCEPT WHERE MANDATED BY GOVERNMENT REQUIREMENTS, TESTING OF ALL PARAMETERS OF EACH PRODUCT IS NOT NECESSARILY PERFORMED. NATIONAL ASSUMES NO LIABILITY FOR APPLICATIONS ASSISTANCE OR BUYER PRODUCT DESIGN. BUYERS ARE RESPONSIBLE FOR THEIR PRODUCTS AND APPLICATIONS USING NATIONAL COMPONENTS. PRIOR TO USING OR DISTRIBUTING ANY PRODUCTS THAT INCLUDE NATIONAL COMPONENTS, BUYERS SHOULD PROVIDE ADEQUATE DESIGN, TESTING AND OPERATING SAFEGUARDS.

EXCEPT AS PROVIDED IN NATIONAL'S TERMS AND CONDITIONS OF SALE FOR SUCH PRODUCTS, NATIONAL ASSUMES NO LIABILITY WHATSOEVER, AND NATIONAL DISCLAIMS ANY EXPRESS OR IMPLIED WARRANTY RELATING TO THE SALE AND/OR USE OF NATIONAL PRODUCTS INCLUDING LIABILITY OR WARRANTIES RELATING TO FITNESS FOR A PARTICULAR PURPOSE, MERCHANTABILITY, OR INFRINGEMENT OF ANY PATENT, COPYRIGHT OR OTHER INTELLECTUAL PROPERTY RIGHT.

#### LIFE SUPPORT POLICY

**NATIONAL'S PRODUCTS ARE NOT AUTHORIZED FOR USE AS CRITICAL COMPONENTS IN LIFE SUPPORT DEVICES OR SYSTEMS WITHOUT THE EXPRESS PRIOR WRITTEN APPROVAL OF THE CHIEF EXECUTIVE OFFICER AND GENERAL COUNSEL OF NATIONAL SEMICONDUCTOR CORPORATION.** As used herein:

Life support devices or systems are devices which (a) are intended for surgical implant into the body, or (b) support or sustain life and whose failure to perform when properly used in accordance with instructions for use provided in the labeling can be reasonably expected to result in a significant injury to the user. A critical component is any component in a life support device or system whose failure to perform can be reasonably expected to cause the failure of the life support device or system or to affect its safety or effectiveness.

National Semiconductor and the National Semiconductor logo are registered trademarks of National Semiconductor Corporation. All other brand or product names may be trademarks or registered trademarks of their respective holders.

Copyright© 2011 National Semiconductor Corporation

For the most current product information visit us at [www.national.com](http://www.national.com)

  
**National Semiconductor**  
Americas Technical  
Support Center  
Email: [support@nsc.com](mailto:support@nsc.com)  
Tel: 1-800-272-9959

**National Semiconductor Europe**  
Technical Support Center  
Email: [europe.support@nsc.com](mailto:europe.support@nsc.com)

**National Semiconductor Asia**  
Pacific Technical Support Center  
Email: [ap.support@nsc.com](mailto:ap.support@nsc.com)

**National Semiconductor Japan**  
Technical Support Center  
Email: [jpn.feedback@nsc.com](mailto:jpn.feedback@nsc.com)

## IMPORTANT NOTICE

Texas Instruments Incorporated and its subsidiaries (TI) reserve the right to make corrections, modifications, enhancements, improvements, and other changes to its products and services at any time and to discontinue any product or service without notice. Customers should obtain the latest relevant information before placing orders and should verify that such information is current and complete. All products are sold subject to TI's terms and conditions of sale supplied at the time of order acknowledgment.

TI warrants performance of its hardware products to the specifications applicable at the time of sale in accordance with TI's standard warranty. Testing and other quality control techniques are used to the extent TI deems necessary to support this warranty. Except where mandated by government requirements, testing of all parameters of each product is not necessarily performed.

TI assumes no liability for applications assistance or customer product design. Customers are responsible for their products and applications using TI components. To minimize the risks associated with customer products and applications, customers should provide adequate design and operating safeguards.

TI does not warrant or represent that any license, either express or implied, is granted under any TI patent right, copyright, mask work right, or other TI intellectual property right relating to any combination, machine, or process in which TI products or services are used. Information published by TI regarding third-party products or services does not constitute a license from TI to use such products or services or a warranty or endorsement thereof. Use of such information may require a license from a third party under the patents or other intellectual property of the third party, or a license from TI under the patents or other intellectual property of TI.

Reproduction of TI information in TI data books or data sheets is permissible only if reproduction is without alteration and is accompanied by all associated warranties, conditions, limitations, and notices. Reproduction of this information with alteration is an unfair and deceptive business practice. TI is not responsible or liable for such altered documentation. Information of third parties may be subject to additional restrictions.

Resale of TI products or services with statements different from or beyond the parameters stated by TI for that product or service voids all express and any implied warranties for the associated TI product or service and is an unfair and deceptive business practice. TI is not responsible or liable for any such statements.

TI products are not authorized for use in safety-critical applications (such as life support) where a failure of the TI product would reasonably be expected to cause severe personal injury or death, unless officers of the parties have executed an agreement specifically governing such use. Buyers represent that they have all necessary expertise in the safety and regulatory ramifications of their applications, and acknowledge and agree that they are solely responsible for all legal, regulatory and safety-related requirements concerning their products and any use of TI products in such safety-critical applications, notwithstanding any applications-related information or support that may be provided by TI. Further, Buyers must fully indemnify TI and its representatives against any damages arising out of the use of TI products in such safety-critical applications.

TI products are neither designed nor intended for use in military/aerospace applications or environments unless the TI products are specifically designated by TI as military-grade or "enhanced plastic." Only products designated by TI as military-grade meet military specifications. Buyers acknowledge and agree that any such use of TI products which TI has not designated as military-grade is solely at the Buyer's risk, and that they are solely responsible for compliance with all legal and regulatory requirements in connection with such use.

TI products are neither designed nor intended for use in automotive applications or environments unless the specific TI products are designated by TI as compliant with ISO/TS 16949 requirements. Buyers acknowledge and agree that, if they use any non-designated products in automotive applications, TI will not be responsible for any failure to meet such requirements.

Following are URLs where you can obtain information on other Texas Instruments products and application solutions:

### Products

|                        |  |
|------------------------|--|
| Audio                  | <a href="http://www.ti.com/audio">www.ti.com/audio</a>                               |
| Amplifiers             | <a href="http://amplifier.ti.com">amplifier.ti.com</a>                               |
| Data Converters        | <a href="http://dataconverter.ti.com">dataconverter.ti.com</a>                       |
| DLP® Products          | <a href="http://www.dlp.com">www.dlp.com</a>   |
| DSP                    | <a href="http://dsp.ti.com">dsp.ti.com</a>   |
| Clocks and Timers      | <a href="http://www.ti.com/clocks">www.ti.com/clocks</a>                             |
| Interface              | <a href="http://interface.ti.com">interface.ti.com</a>                               |
| Logic                  | <a href="http://logic.ti.com">logic.ti.com</a>                                       |
| Power Mgmt             | <a href="http://power.ti.com">power.ti.com</a>                                       |
| Microcontrollers       | <a href="http://microcontroller.ti.com">microcontroller.ti.com</a>                   |
| RFID                   | <a href="http://www.ti-rfid.com">www.ti-rfid.com</a>                                 |
| OMAP Mobile Processors | <a href="http://www.ti.com/omap">www.ti.com/omap</a>                                 |
| Wireless Connectivity  | <a href="http://www.ti.com/wirelessconnectivity">www.ti.com/wirelessconnectivity</a> |

### Applications

|                               |  |
|-------------------------------|--|
| Communications and Telecom    | <a href="http://www.ti.com/communications">www.ti.com/communications</a>                 |
| Computers and Peripherals     | <a href="http://www.ti.com/computers">www.ti.com/computers</a>                           |
| Consumer Electronics          | <a href="http://www.ti.com/consumer-apps">www.ti.com/consumer-apps</a>                   |
| Energy and Lighting           | <a href="http://www.ti.com/energy">www.ti.com/energy</a>                                 |
| Industrial                    | <a href="http://www.ti.com/industrial">www.ti.com/industrial</a>                         |
| Medical                       | <a href="http://www.ti.com/medical">www.ti.com/medical</a>                               |
| Security                      | <a href="http://www.ti.com/security">www.ti.com/security</a>                             |
| Space, Avionics and Defense   | <a href="http://www.ti.com/space-avionics-defense">www.ti.com/space-avionics-defense</a> |
| Transportation and Automotive | <a href="http://www.ti.com/automotive">www.ti.com/automotive</a>                         |
| Video and Imaging             | <a href="http://www.ti.com/video">www.ti.com/video</a>                                   |

TI E2E Community Home Page

[e2e.ti.com](http://e2e.ti.com)

Mailing Address: Texas Instruments, Post Office Box 655303, Dallas, Texas 75265  
Copyright © 2011, Texas Instruments Incorporated