

400 mA Step-Down DC/DC Converter with Built-in Inductor

FEATURES

- **Built-in inductor and transistors**
- **Operating Input Voltage Range:** 2.0 V ~ 6.0 V
- **Output Voltage Range:** 0.8 V ~ 4.0 V
- **Output Voltage Error:** $\pm 2\%$
- **Output Current:** 600 mA
- **High Efficiency:** 92% ($V_{IN} = 4.2\text{ V}$, $V_{OUT} = 3.3\text{ V}$)
- **Oscillation Frequency:** 1.2 MHz
- **Maximum Duty Cycle:** 100%
- **Operating Modes:** PWM, PWM/PFM auto select
- **Functions:** Chip Enable, Built-in Current Limit, High Speed Load Capacitor Discharge, Soft start
- **Operating Ambient temperature:** $-40 \sim +85^{\circ}\text{C}$
- **Package Size:** 2.5 x 2.0 x 1.0 mm
- **EU RoHS Compliant, Pb Free**

APPLICATION

- Mobile Phones
- Bluetooth headsets
- Digital home appliances
- Office automation equipment
- Various portable equipment

DESCRIPTION

The IXD9201/02 series are synchronous step-down DC/DC converters with an inductor and a control IC in one tiny (2.5 x 2.0 x 1.0 mm) package. A stable

power supply with an output current of 400 mA requires only two capacitors connected externally.

Operating voltage range is from 2.0 V to 6.0 V. Output voltage is internally set in a range from 0.8 V to 4.0 V in 0.05 V increments. The device operates at 1.2 MHz switching frequency, and includes a 0.42 Ω P-channel switching transistor and a 0.52 Ω N-channel transistor for synchronous rectification. The IXD9201 series operates in PWM mode, while the IXD9202 series automatically switches between PWM/PFM modes.

An automatic PWM/PFM switching allows fast response to the load changes, low ripple noise, and high efficiency over the full range of loads.

The CE pin enables setting the device into stand-by mode with a current consumption below 1.0 μA .

The built-in Under Voltage Lockout (UVLO) function forces the internal switching transistor OFF when the input voltage becomes less than 1.4V.

The IXD9201/02 series has a fast soft start function internally set at 0.25 ms (typ).

The IXD9201/02 series also has a fast load capacitor C_L auto discharge function, which allows fast C_L discharge through a switch located between the L_X and V_{SS} pins. When the devices enter stand-by mode, the output voltage quickly returns to the V_{SS} level because of this function.

TYPICAL APPLICATION CIRCUIT

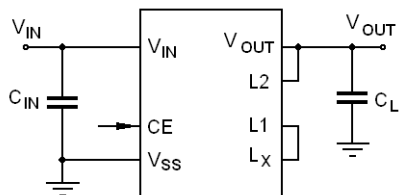

Pins L1 – L_X and L2 – V_{OUT} should be connected externally

TYPICAL PERFORMANCE CHARACTERISTIC

Efficiency vs. Output Current ($f_{OSC} = 1.2\text{ MHz}$, $V_{OUT} = 3.3\text{ V}$)

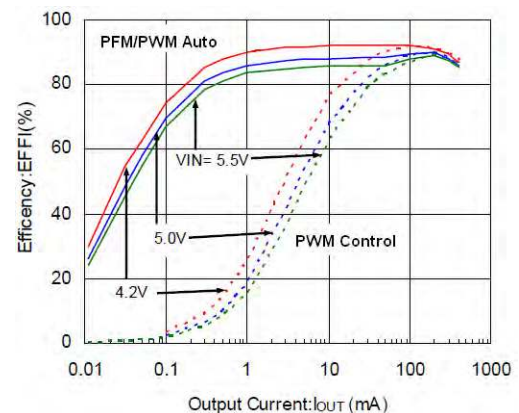

ABSOLUTE MAXIMUM RATINGS

PARAMETER	SYMBOL	RATINGS	UNITS
V _{IN} Pin Voltage	V _{IN}	- 0.3 ~ 6.5	V
L _X Pin Voltage	V _{LX}	- 0.3 ~ V _{IN} + 0.3 ¹	V
V _{OUT} Pin Voltage	V _{OUT}	- 0.3 ~ 6.5	V
FB Pin Voltage	V _{FB}	- 0.3 ~ 6.5	V
CE/MODE Pin Voltage	V _{CE}	- 0.3 ~ 6.5	V
L _X Pin Current	I _{LX}	±1500	mA
Inductor Current at ΔT = 40°C	I _{LMAX}	600	mA
Power Dissipation	P _D	1000 ²⁾	mW
Operating Temperature Range	T _{OPR}	- 40 ~ + 85	°C
Storage Temperature Range	T _{STG}	- 50 ~ +105	°C

NOTE:

- L_X pin voltage should not exceed V_{IN} + 0.3 V or 6.5 V, which is less.
- Power dissipation shown for a PCB mounted part. Please refer to page 15 for more information.

ELECTRICAL OPERATING CHARACTERISTICS

IXD9201/02 series, T_a = 25°C

PARAMETER	SYMBOL	CONDITIONS	MIN.	TYP.	MAX.	UNIT	CIRCUIT
Operating Voltage Range	V _{IN}		2.0	-	6.0	V	①
Output Voltage	V _{OUT}	V _{IN} = V _{CE} = 5.0 V, I _{OUT} = 30 mA	E-1	E-2	E-3	V	①
Maximum Output Current	I _{OUT_MAX}	V _{IN} = V _{OUT(E)} + 2.0 V, V _{CE} = 1.0 V ⁸⁾	400			mA	①
UVLO Voltage	V _{UVLO}	V _{CE} = V _{IN} , V _{OUT} = 0 ¹⁾	1.00	1.40	1.78	V	③
Supply Current	IXD9201	I _Q		22	50	μA	②
	IXD9202			15	33		
Standby Current	I _{STB}	V _{IN} = 5.0 V, V _{CE} = 0 V, V _{OUT} = V _{OUT(E)} x 1.1 V		0	1.0	μA	②
Oscillation Frequency	f _{OSC}	V _{IN} = V _{OUT(E)} + 2 V, V _{CE} = 1.0 V, I _{OUT} = 100 mA	1020	1200	1380	kHz	①
PFM Switching Current	I _{PFM} ¹¹⁾	V _{IN} = V _{CE} = V _{OUT(E)} + 2 V, I _{OUT} = 1 mA	E-4	E-5	E-6	mA	⑨
P-channel ON time maximum	t _{PON_MAX} ¹¹⁾	V _{IN} = V _{CE} = V _{OUT(T)} + 1 V, I _{OUT} = 1 mA		2D _{max}	3D _{MAX}		①
Maximum Duty Cycle Ratio	D _{MAX}	V _{IN} = V _{CE} = 5.0 V, V _{OUT} = V _{OUT(E)} x 0.9 V	100			%	③
Minimum Duty Cycle Ratio	D _{MIN}	V _{IN} = V _{CE} = 5.0 V, V _{OUT} = V _{OUT(E)} x 1.1 V			0	%	③
Efficiency ²⁾	EFFI	V _{IN} = V _{CE} = V _{OUT(E)} + 1.2 V, I _{OUT} = 100 mA		E-7		%	①
L _X "H" ON Resistance ¹³⁾	R _{LXH1}	V _{IN} = V _{CE} = 5.0 V, V _{OUT} = 0 V, I _{LX} = 100 mA		0.35	0.55	Ω	④
L _X "H" ON Resistance ²³⁾	R _{LXH2}	V _{IN} = V _{CE} = 3.6 V, V _{OUT} = 0 V, I _{LX} = 100 mA		0.42	0.67	Ω	④
L _X "L" ON Resistance ¹⁴⁾	R _{LXL1}	V _{IN} = V _{CE} = 5.0 V		0.45	0.65	Ω	
L _X "L" ON Resistance ²⁴⁾	R _{LXL2}	V _{IN} = V _{CE} = 3.6 V		0.52	0.77	Ω	
L _X "H" Leakage Current ⁵⁾	I _{LXH}	V _{IN} = V _{CE} = 5.0 V, V _{OUT} = 0 V, V _{LX} = 5.0 V		0.01	1.0	μA	⑤
L _X "L" Leakage Current ⁵⁾	I _{LXH}	V _{IN} = V _{CE} = 5.0 V, V _{OUT} = 0 V, V _{LX} = 5.0 V		0.01	1.0	μA	⑤
Current Limit ⁹⁾	I _{LIM}	V _{IN} = V _{CE} = 5.0 V, V _{OUT} = V _{OUT(E)} x 0.9 V ⁷⁾	700	800	1000	mA	⑥
Output Voltage Temperature Characteristics	$\frac{\Delta V_{OUT}}{V_{OUT} * \Delta T_{OPR}}$	-40°C ≤ T _{OPR} ≤ 85°C, I _{OUT} = 30 mA		±100		ppm/°C	①
CE "H" Voltage ¹⁰⁾	V _{CEH}	V _{OUT} = 0 V	0.65		6.0	V	③
CE "L" Voltage ¹¹⁾	V _{CEL}	V _{OUT} = 0 V	0		0.25	V	③
CE "H" Current	I _{ENH}	V _{IN} = V _{CE} = 5.0 V, V _{OUT} = 0 V	-0.1		0.1	μA	⑤
CE "L" Current	I _{ENL}	V _{IN} = 5.0 V, V _{CE} = 0 V, V _{OUT} = 0 V	-0.1		0.1	μA	⑤
Soft-Start Time	t _{SS}	I _{OUT} = 1 mA		E-11	E-12	ms	①
Latch Time ⁷⁾	t _{LAT}	V _{IN} = V _{CE} = 5.0 V, V _{OUT} = 0.8 x V _{OUT(E)} , L _X short with 1 Ω resistor to ground	1.0		20.0	ms	⑦

ELECTRICAL OPERATING CHARACTERISTICS (CONTINUED)

PARAMETER	SYMBOL	CONDITIONS	MIN.	TYP.	MAX.	UNIT	CIRCUIT
Short Protection Threshold Voltage	V_{SHORT}	$V_{IN} = V_{CE} = 5.0\text{ V}$, L_X short with $1\ \Omega$ resistor to ground	E-8	E-9	E-10	V	⑦
C_L Discharge Resistance	R_{CLD}	$V_{IN} = L_X = 5\text{ V}$, $V_{CE} = 0$, $V_{OUT} = \text{open}$	200	300	450	Ω	⑧
Inductance Value	L	Test frequency 1 MHz		4.7		μH	
Inductor Current Maximum	I_{LMAX}	$\Delta T = 40^\circ\text{C}$		600		mA	

NOTE:

Test conditions: Unless otherwise stated, $V_{IN} = 5.0\text{ V}$, $V_{OUT(E)} =$ Nominal Voltage

- 1) Including hysteresis operating voltage range
- 2) $EFFI = \{(\text{output voltage} \times \text{output current}) / (\text{input voltage} \times \text{input current})\} \times 100\%$
- 3) ON resistance (Ω) = $(V_{IN} - L_x \text{ pin measurement voltage}) / 100\text{mA}$
- 4) Design target value
- 5) A $10\mu\text{A}$ (maximum) current may leak at high temperature
- 6) Time from moment when V_{OUT} is shorted to GND via $1\ \Omega$ resistor to the moment, when Current Limit generates pulse stopping L_X oscillations
- 7) When V_{IN} is less than 2.4 V , current limit may not be reached because of voltage drop across ON resistance
- 8) When the difference between input and output voltage is small, some cycles may be skipped completely before current maximizes. If load current increases in this state, output voltage will decrease because of the voltage drop across P-channel transistor
- 9) Current limit denotes the level of an inductor peak current
- 10) Voltage, when L_X pin voltage is "H" = $V_{IN} \sim V_{IN} - 1.2\text{ V}$
- 11) Voltage, when L_X pin voltage is "L" = $+0.1\text{ V} \sim -0.1\text{ V}$
- 12) IXD9202 series only

E-TABLES

Output Voltage Error

NOMINAL OUTPUT VOLTAGE $V_{OUT(T)}$, V	V_{OUT} , (V)		
	E-1 MIN	E-2 TYP	E-3 MAX
1.00	0.980	1.000	1.020
1.20	1.176	1.200	1.224
1.50	1.470	1.500	1.530
1.80	1.764	1.800	1.836
2.50	2.450	2.500	2.550
2.80	2.744	2.800	2.856
3.00	2.940	3.000	3.060
3.30	3.234	3.300	3.366

PFM Switching Current

NOMINAL OUTPUT VOLTAGE	I_{PFM} , (mA)		
	E-4 MIN	E-5 MAX	E-6 TYP
$V_{OUT(T)} < 1.2\text{ V}$	190	260	350
$1.2\text{ V} < V_{OUT(T)} \leq 1.75\text{ V}$	140	180	240
$1.8\text{ V} < V_{OUT(T)}$	120	160	200

Efficiency

NOMINAL OUTPUT VOLTAGE $V_{OUT(T)}$, V	EFFICIENCY, %
	E-7
1.20	86
1.8	89

Short Circuit Protection Threshold Voltage

NOMINAL OUTPUT VOLTAGE $V_{OUT(T)}$, V	V_{SHORT} , (V)		
	E-8 MIN	E-9 TYP	E-10 MAX
1.20	0.450	0.600	0.750
1.80	0.675	0.900	1.125

Soft-Start Time

NOMINAL OUTPUT VOLTAGE $V_{OUT(T)}$, V	t_{SS} , (ms)	
	E-11 TYP	E-12 MAX
$0.8\text{ V} < V_{OUT(T)} \leq 1.75\text{ V}$	0.25	0.4
$1.8\text{ V} < V_{OUT(T)} \leq 4.0\text{ V}$	0.32	0.5

PIN CONFIGURATION

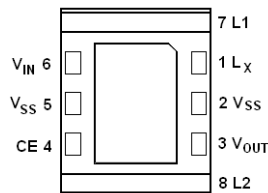

NOTE:

The dissipation pad should be soldered in recommended mount pattern and metal masking to enhance mounting strength and heat release. If the pad needs to be connected to other pins, it should be connected to the V_{SS} (No 2 and No 5) pins.

V_{SS} pins (No. 2 and 5) should be tied together and connected to ground plane on the board.

PIN ASSIGNMENT

PIN NUMBER	PIN NAME	FUNCTIONS
1	L_X	Switching Node
2, 5	V_{SS}	Ground
3	V_{OUT}	Fixed Output Voltage
4	CE	Enable (Active HIGH)
6	V_{IN}	Power Input
7	L_1	Inductor Connection
8	L_2	Inductor Connection

BLOCK DIAGRAM

IXD9201/02 Series

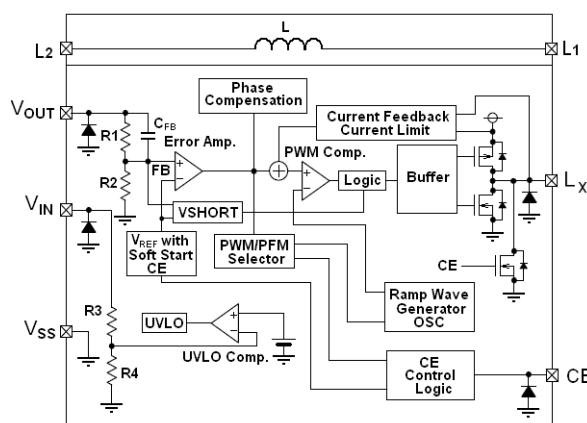

Internal diodes include an ESD protection and a parasitic diode

BASIC OPERATION

The IXD9201/02 series consists of a Reference Voltage source, Ramp Wave Generator, Error Amplifier, PWM Comparator, Phase Compensation circuit, output voltage resistive divider, P-channel switching transistor, N-channel transistor for the synchronous switch, Current Limiter circuit, UVLO circuit, and others. (See the block diagrams above.)

The Error Amplifier compares output voltage divided by internal resistors R_1/R_2 with the internal reference voltage. Amplified difference between these two signals applies to the one input of the PWM Comparator, while ramp voltage from the Ramp Wave Generator applies to the second input. Resulting PWM pulse determines switching transistor ON time. It goes through the Buffer and it appears at the gate of the internal P-channel switching transistor. This continuous process stabilizes output voltage.

The Current Feedback circuit monitors current of the P-channel transistor at each switching cycle, and modulates output signal from the Error Amplifier to provide additional feedback. This guarantees a stable converter operation even with low ESR ceramic load capacitor.

Reference Voltage Source

The Reference Voltage Source provides the reference voltage to ensure stable output voltage of the DC/DC converter.

Ramp Wave Generator

The Ramp Wave Generator produces a ramp waveform signal needed for PWM operation, and signals to synchronize all the internal circuits. It operates at internally fixed 1.2 MHz or 3.0 MHz frequency.

Error Amplifier

The Error Amplifier monitors output voltage through resistive divider connected to V_{OUT} (FB) pin. If output voltage falls below preset value and Error Amplifier's input signal becomes less than internal reference voltage, the Error Amplifier's output signal increases. That results in wider PWM pulse and respectively longer ON time for switching transistor to increase output voltage. The gain and frequency characteristics of the error amplifier output are fixed internally to optimize IC performance.

Current Limiter

The Current Limiter circuit monitors current flowing through the P-channel transistor connected to the Lx pin, and combines the function of the current limit and operation suspension.

When the transistor's current is greater than a specified level, the Current Limiter turns off the P-channel transistor immediately. After that, the Current Limiter turns off too, returning to monitoring mode.

The driver transistor turns on at the next cycle, but the Current Limiter turns it off immediately if an over-current exists. When the over-current state is eliminated, the IC resumes its normal operation.

The IC waits for end of the over-current state repeating the steps listed above (t_1 on figure below). If an over-current state continues for a few ms with IC repeatedly performing the steps above, the Current Limiter latches the P-channel transistor in OFF state, and the IC suspends operations (t_2 on figure below). To restart IC operation after this condition, either the CE pin should be toggled H – L – H, or the V_{IN} pin voltage should be set below UVLO to resume operations from soft start.

The suspension mode is not a standby mode. In the suspension mode, pulse output is suspended; however, internal circuitries remain in operation mode consuming power.

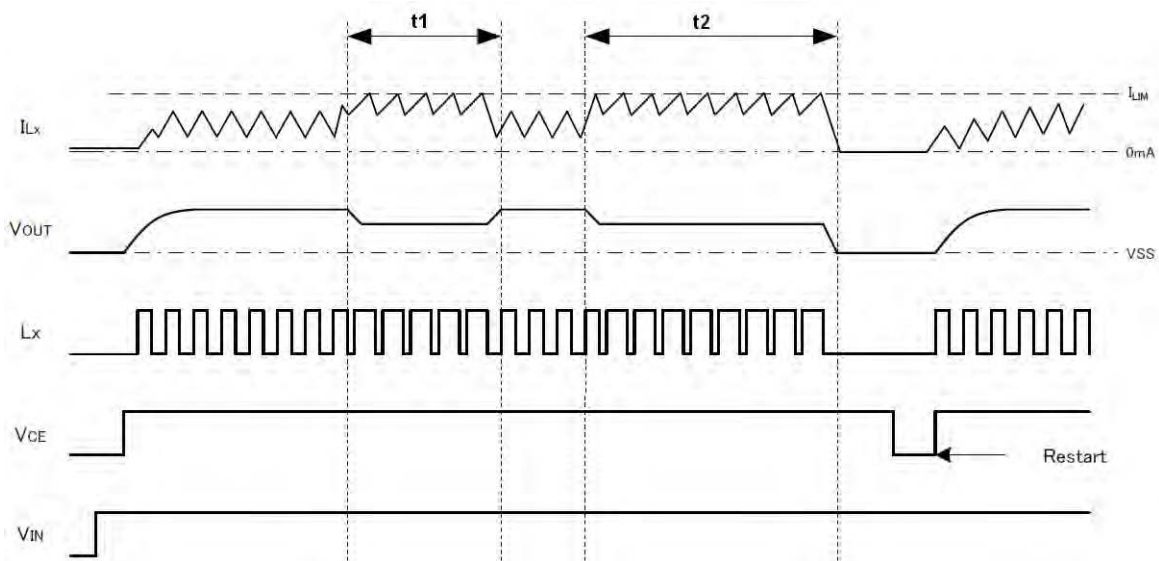

Short-Circuit Protection

The short-circuit protection monitors the R_{FB1}/R_{FB2} divider voltage (FB point in the block diagram). If output is accidentally shorted to the ground, FB voltage starts falling. When this voltage becomes less than half of the reference voltage (V_{REF}) and the P-channel switching transistor's current is more than the I_{LIM} threshold, the Short-Circuit Protection turns off and quickly latches the P-channel transistor.

At D/E/F/G series, Short Circuit Protection starts after the FB voltage becomes less than 0.25 of reference voltage (V_{REF}), irrespective of the transistor's current.

To restart IC operation after this condition, either the EN pin should be toggled H – L – H, or the V_{IN} pin voltage should be set below UVLO to resume operations from soft start.

The sharp load transients creating a voltage drop at the V_{OUT} , propagate to the FB point through C_{FB} , that may result in Short Circuit protection operating at voltages higher than $1/2 V_{REF}$ voltage.

UVLO Circuit

When the V_{IN} pin voltage becomes 1.4 V or lower, the P-channel transistor is forced OFF to prevent false pulse output caused by unstable operation of the internal circuitry. When the V_{IN} pin voltage becomes 1.8 V or higher, switching operations resume with the soft start. The soft start function operates even when the V_{IN} voltage falls below the UVLO threshold for a very short time. The UVLO circuit does not cause a complete shutdown of the IC, but causes pulse output to be suspended; therefore, the internal circuitry remains in operation.

PFM Switch Current

In PFM mode, the IC keeps the P-channel transistor on until inductor current reaches a specified level (I_{PFM}).

P-channel transistor's ON time is equal

$$t_{ON} = L \times I_{PFM} / (V_{IN} - V_{OUT}), \mu s,$$

where L is an inductance in μH , and I_{PFM} is a current limit in A.

PFM Duty Limit

In PFM mode, P-channel ON time maximum (t_{PON_MAX}) is set to $2D_{MAX}$, i.e. two periods of the switching frequency. Therefore, under conditions, when the ON time increases (i.e. step-down ratio is small), it is possible that P-channel transistor to be turned off, even when inductor current does not reach to I_{PFM} . (See Figures 1 and 2 below)

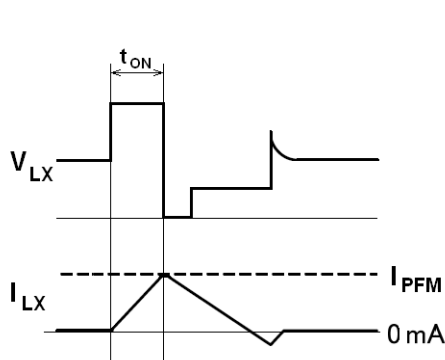

Figure 1

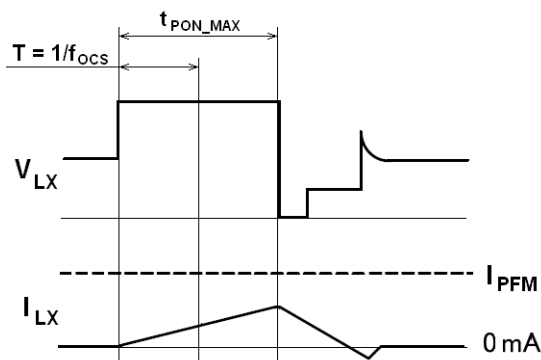

Figure 2

C_L High Speed Discharge

The IXD9201/02B, C, and G series can quickly discharge the output capacitor (C_L) to avoid application malfunction, when CE pin set logic LOW to disable IC.

C_L Discharge Time is proportional to the resistance (R) of the N-channel transistor located between the L_X pin and ground and the output C_L capacitance as shown below.

$$t_{DSH} = RC_L \times \ln(V_{OUT(E)} / V), \text{ where}$$

V - Output voltage after discharge

$V_{OUT(E)}$ - Output voltage

R = 300 Ω (Typical value)

Output Voltage Discharge Characteristics

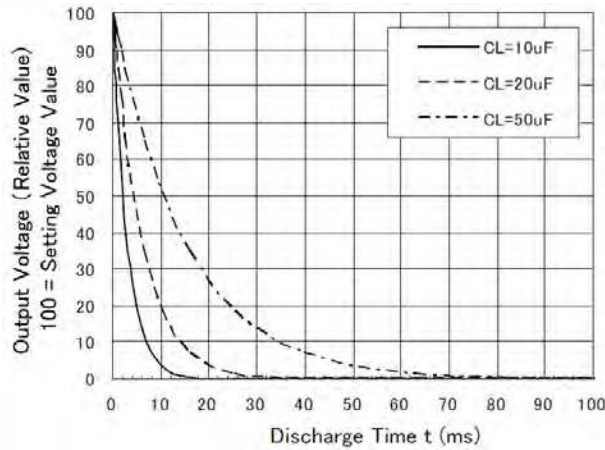

CE Pin Function

The IXD9201/02 series enters shut down mode, when a LOW logic-level signal applies to the CE pin. In shutdown mode, IC current consumption is $\sim 0 \mu\text{A}$ (Typical value), with the Lx and V_{OUT} pins at high impedance state. The IC starts its operation when a HIGH logic-level signal applies to the CE. The IC does not have pull-up/down resistors at CE input, therefore do not leave this input open to avoid unstable IC operation.

Soft Start

Soft start time is available in two options via product selection.

The soft-start time of the IXD9201/02 series is optimized by using internal circuits. The definition of the soft-start time is the time when the output voltage goes up to the 90% of nominal output voltage after the IC is enabled by CE "H" signal.

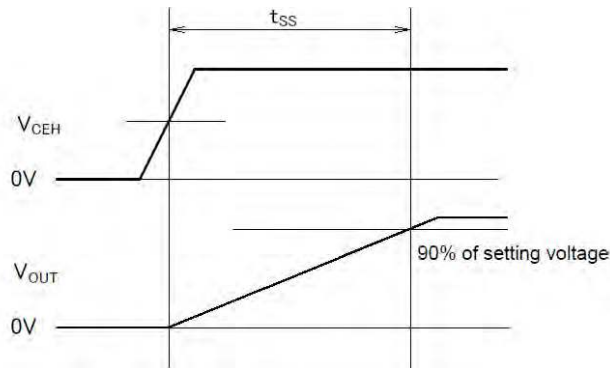

TYPICAL APPLICATION CIRCUIT

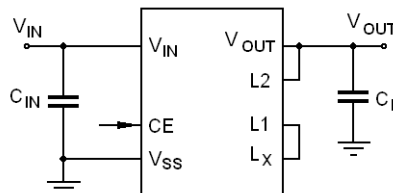

EXTERNAL COMPONENTS

f_{osc}	3.0 MHz
$C_{\text{IN}}, \mu\text{F}$	4.7
$C_{\text{L}}, \mu\text{F}$	10

Capacitors should be X7R or X5R series to minimize power losses.

LAYOUT AND USE CONSIDERATIONS

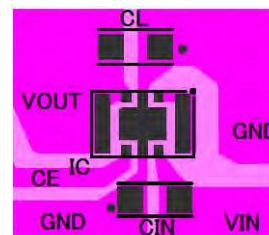

1. Wire external components as close to the IC as possible and use thick, short connecting traces to reduce the circuit impedance. Please, pay special attention to the V_{IN} and GND wiring. Switching noise, which occurs from the GND, may cause the instability of the IC, so, position V_{IN} and V_{CL} capacitors as close to IC as possible (See recommended layout on the right).
2. Transitional voltage drops or voltage rising phenomenon could make the IC unstable if ratings are exceeded.
3. The IXD9201/02 series are designed to work with ceramic output capacitors. However, if the difference between input and output voltages is too high, a ceramic capacitor may fail to absorb the resulting high switching energy and oscillation could occur. In this case, connect an electrolytic capacitor in parallel to ceramic one to compensate for insufficient capacitance.
4. In PWM mode, IC generates very narrow pulses, and there is a possibility that some cycles will be skipped completely, if the difference between V_{IN} and V_{OUT} is high.
5. If the difference between V_{IN} and V_{OUT} is small, IC generates very wide pulses, and there is a possibility that some cycles will be skipped completely at the heavy load current.
6. When dropout voltage or load current is high, Current Limit may activate prematurely that will lead to IC instability. To avoid this condition, choose inductor's value to set peak current below Current Limit threshold. Calculate the peak current according to the following formula:

$$I_{PK} = (V_{IN} - V_{OUT}) \times D / (2 \times L \times f_{OSC}) + I_{OUT}, \text{ where}$$

L - Inductance

f_{OSC} -- Oscillation Frequency

D – Duty cycle

7. Inductor's rated current exceeds Current Limit threshold of 1050 mA to avoid damage, which may occur until P-channel transistor turns off after Current Limiter activates, but pulse current may exceed this

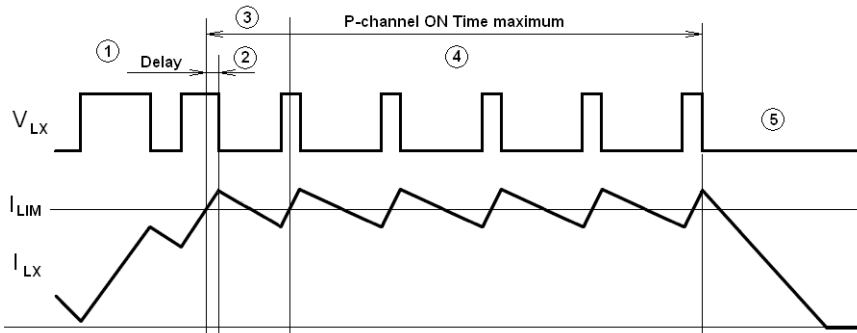

value(see figure below).

- ① Current flows into P-channel transistor reaches the current limit (I_{LIM}).
- ② Current is more than I_{LIM} due the circuit's delay time from the current limit detection to the P-channel transistor OFF.
- ③ The inductor's current time rate becomes quite small.
- ④ IC generates very narrow pulses for several milliseconds.
- ⑤ The circuit latches, stopping operation.

8. If V_{IN} voltage is less than 2.4 V, current limit threshold may be not reached due voltage drop caused by switching transistor's ON resistance
9. Latch time may become longer or latch may not work due electrical noise. To avoid this effect, the board should be laid out so that input capacitors are placed as close to the IC as possible.
10. Use of the IC at voltages below recommended voltage range may lead to instability.
11. At high temperature, output voltage may increase up to input voltage level at no load, because of the leakage current of the driver transistor.
12. High step-down ratio and very light load may be cause of intermittent oscillations in PWM mode.
13. In PWM/PFM automatic switching mode, IC may become unstable during transition to continuous mode. Please verify with actual components.

TEST CIRCUITS

Circuit ①

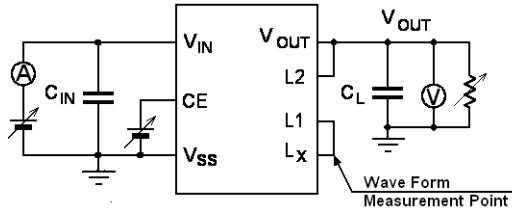

Circuit ②

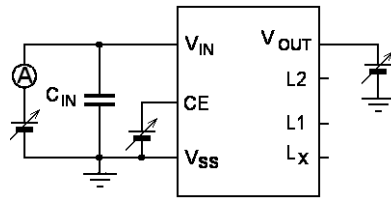

Circuit ③

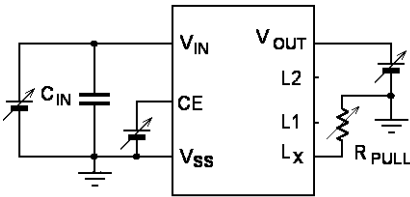

Circuit ④

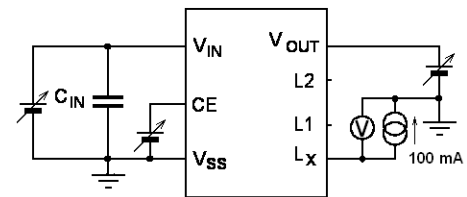

$ON\ Resistance = (V_{IN} - V_{out}) / 100\ mA$

Circuit ⑤

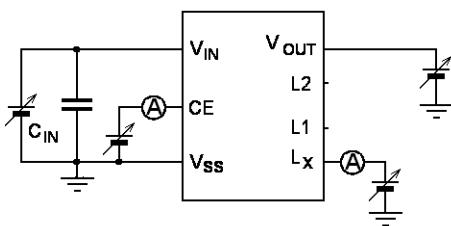

Circuit

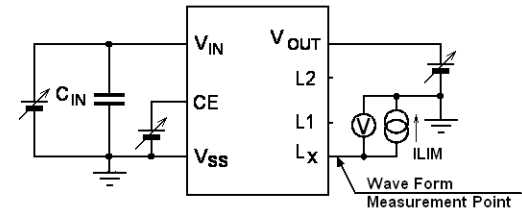

Circuit ⑥

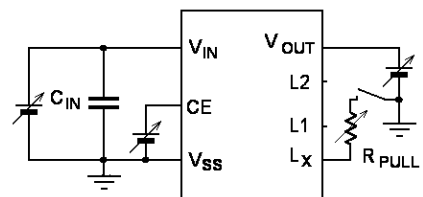

Circuit ⑦

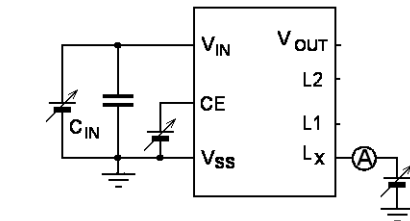

Circuit

$R_{PULL} = 1\ \Omega$

Circuit ⑧

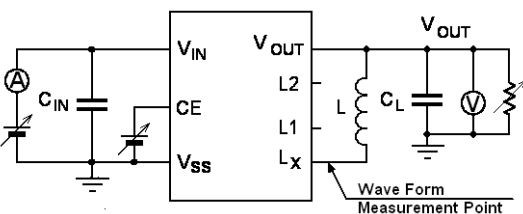

External Components
 $C_{IN} = 4.7\ \mu F$ (ceramic), $C_L = 10\ \mu F$ (ceramic)
 $L = 1.5\ \mu H$
 $R_{PULL} = 200\ \Omega$

TYPICAL PERFORMANCE CHARACTERISTICS

(1) Efficiency vs. Output Current

IXD920xB181BR-G
 $C_{IN} = 4.7 \mu F, C_L = 10 \mu F$

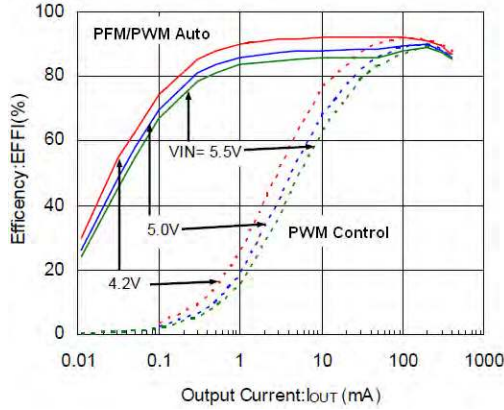

(2) Output Voltage vs. Output Current

IXD920xB181BR-G

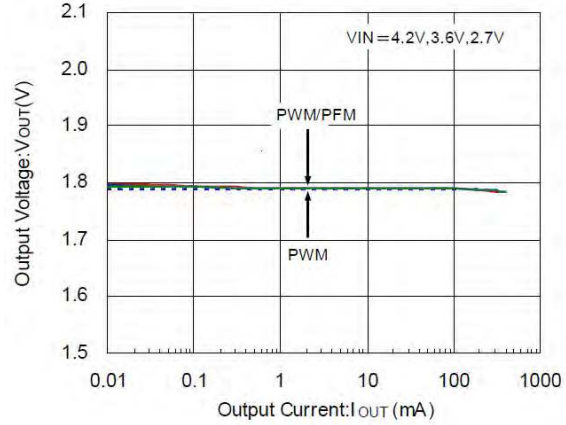

(3) Ripple Voltage vs. Output Current

IXD920xB181BR-G

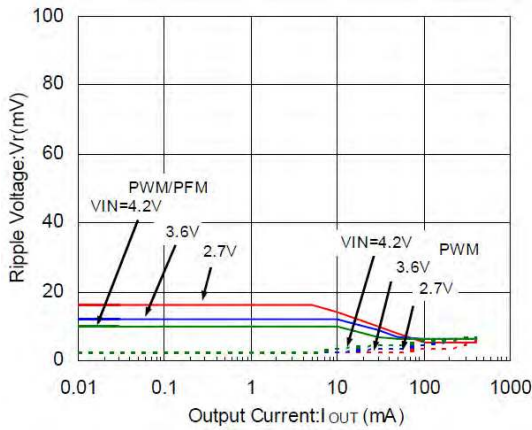

(4) Oscillation Frequency vs. Ambient Temperature

IXD920xB181BR-G

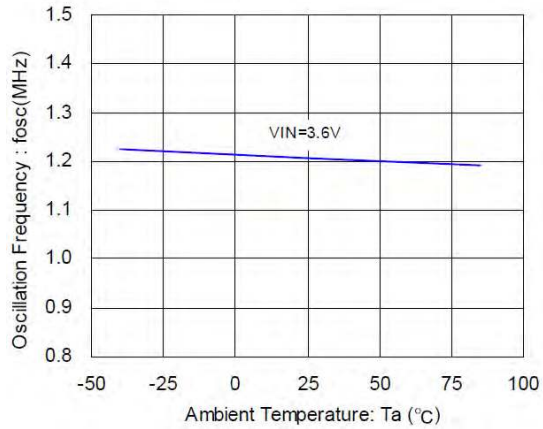

(5) Supply Current vs. Ambient Temperature

IXD9202B181BR-G

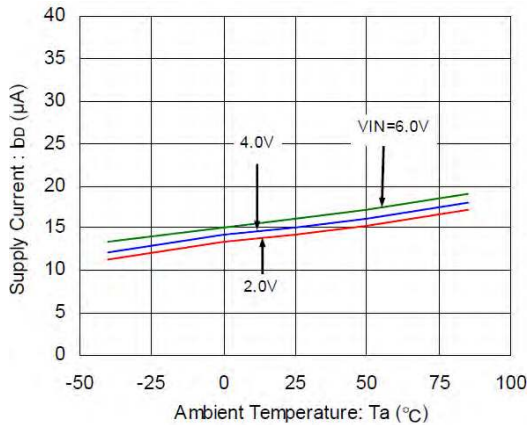

(6) Output Voltage vs. Ambient Temperature

IXD920xB181BR-G

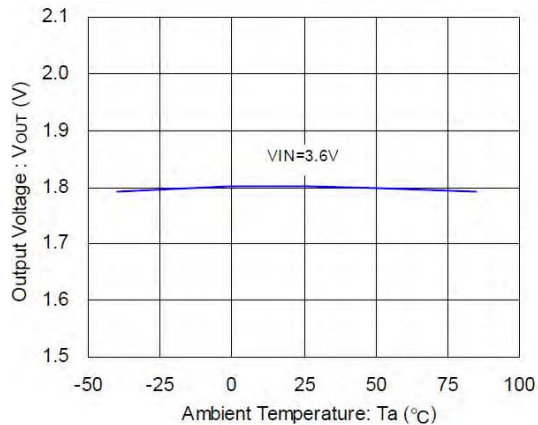

TYPICAL PERFORMANCE CHARACTERISTICS (Continued)

(7) UVLO Voltage vs. Ambient Temperature

IXD920xB181BR-G

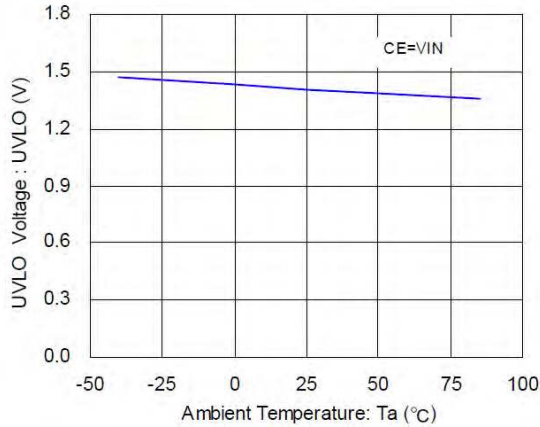

(8) CE "H" Voltage vs. Ambient Temperature

IXD920xB181BR-G

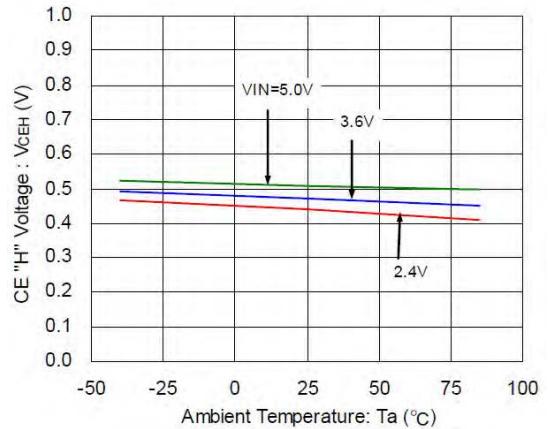

(9) CE "L" Voltage vs. Ambient Temperature

IXD920xB181BR-G

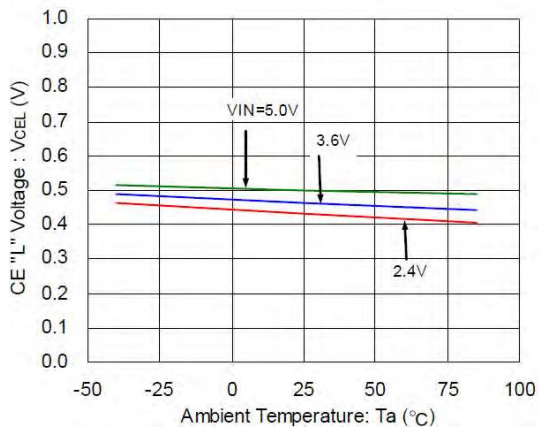

(10) ON Resistance vs. Ambient Temperature

IXD920xB181BR-G

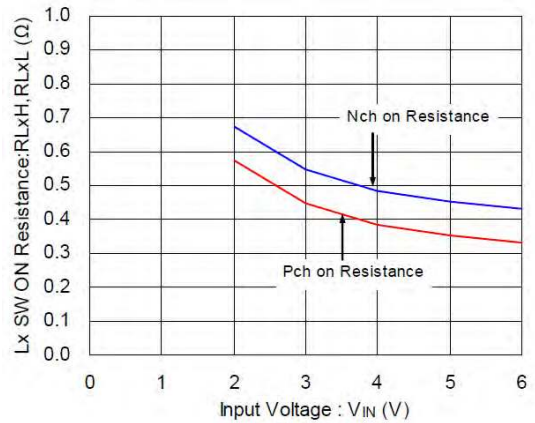

(11) Start Wave Form

IXD920xB331BR-G

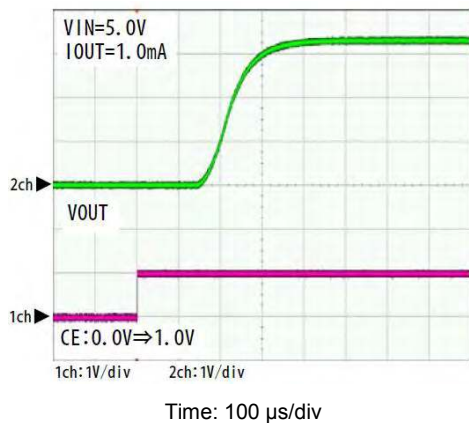

(12) Soft Start Time vs. Ambient Temperature

IXD920xB121BR-G

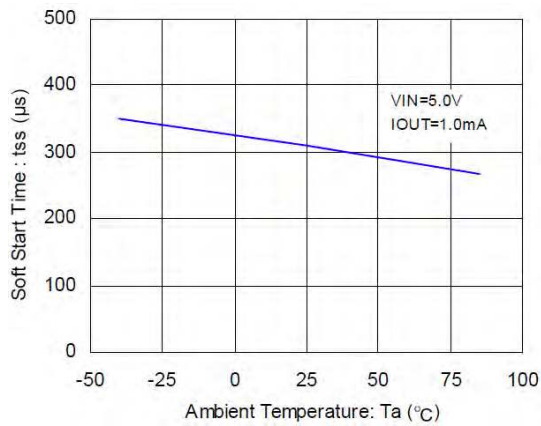

(13) C_L Discharge Time vs. Ambient Temperature

IXD920xB331BR-G

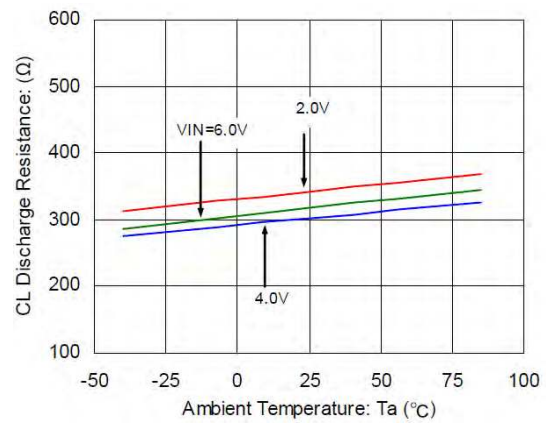

(14) Load Transient Response

MODE: PWM/PFM Auto Switching

IXD9202B181BR-G

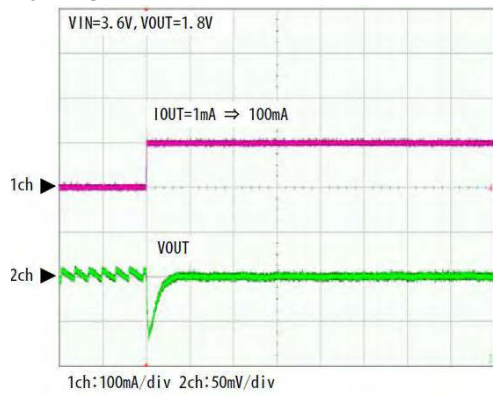

Ch1 – I_{OUT} , Ch2 – V_{OUT} 50 mV/div, Time – 200 μ s/div

IXD9202B181BR-G

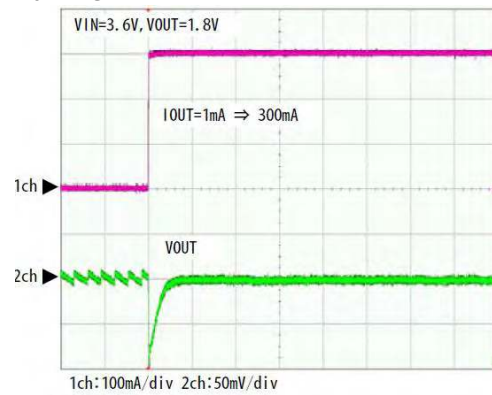

Ch1 – I_{OUT} , Ch2 – V_{OUT} 50 mV/div, Time – 200 μ s/div

IXD9202B181BR-G

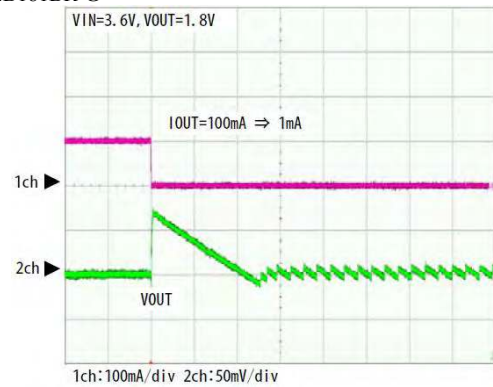

Ch1 – I_{OUT} , Ch2 – V_{OUT} 50 mV/div, Time – 200 μ s/div

IXD9202B181BR-G

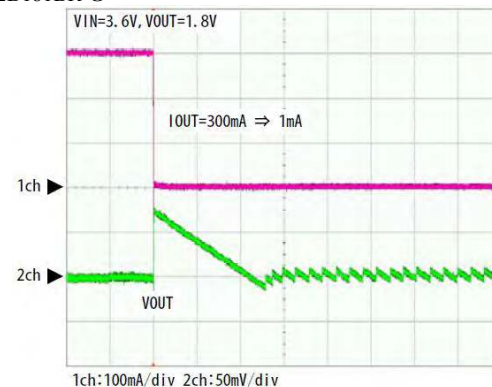

Ch1 – I_{OUT} , Ch2 – V_{OUT} 50 mV/div, Time – 200 μ s/div

TYPICAL PERFORMANCE CHARACTERISTICS (Continued)

(14) Load Transient Response (Continued)

MODE: PWM

IXD9201B181BR-G

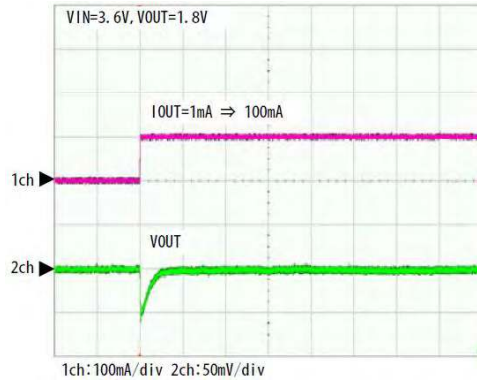

Ch1 – I_{OUT}, Ch2 – V_{OUT} 50 mV/div, Time – 200 µs/div

IXD9201B181BR-G

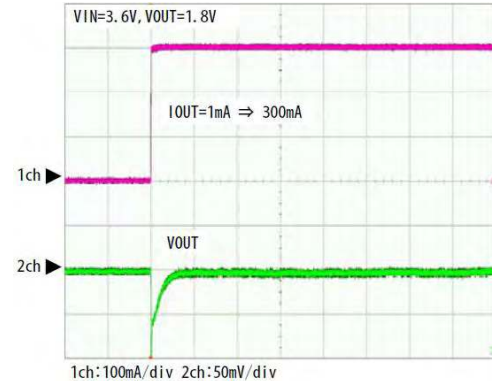

Ch1 – I_{OUT}, Ch2 – V_{OUT} 50 mV/div, Time – 200 µs/div

IXD9201B181BR-G

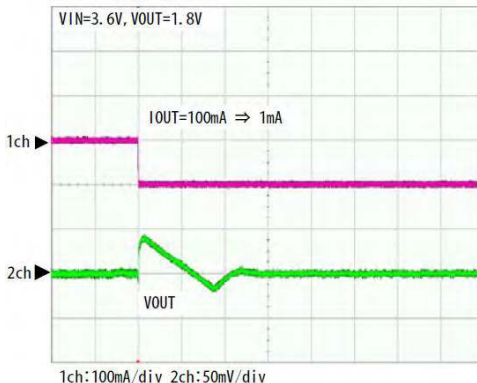

Ch1 – I_{OUT}, Ch2 – V_{OUT} 50 mV/div, Time – 200 µs/div

IXD9201B181BR-G

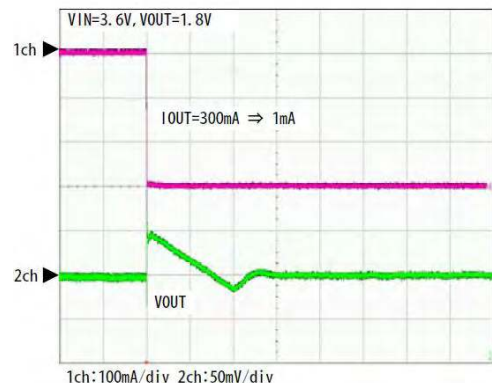

Ch1 – I_{OUT}, Ch2 – V_{OUT} 50 mV/div, Time – 200 µs/div

ORDERING INFORMATION

IXD9201①②③④⑤⑥-⑦ PWM Mode only

IXD9202①②③④⑤⑥-⑦ PFM/PWM Mode auto switching

DESIGNATOR	DESCRIPTION	SYMBOL	DESCRIPTION
①	Type of DC/DC Controller	B	C _L auto discharge, fast soft start
②③	Fixed Output Voltage, V ^②	08 - 40	② - integer part, ③ - decimal part, i.e. V _{OUT} = 2.8 V - ② = 2, ③ = 8
④	Oscillation Frequency	1	1.2 MHz
⑤⑥-⑦ ¹⁾	Packages (Order Limit)	BR-G	CL-2025 (3000/reel)

NOTE:

- 1) The “-G” suffix denotes halogen and antimony free, as well as being fully RoHS compliant.
- 2) Standard output voltages are: 1.0, 1.2, 1.5, 1.8, 2.5, 2.8, 3.0, and 3.3 V. Contact local representative for more information, if other voltages in the range from 0.8 to 4.0 V require.

PACKAGE DRAWING AND DIMENSIONS

(Units: mm)

CL-2025

Bottom View

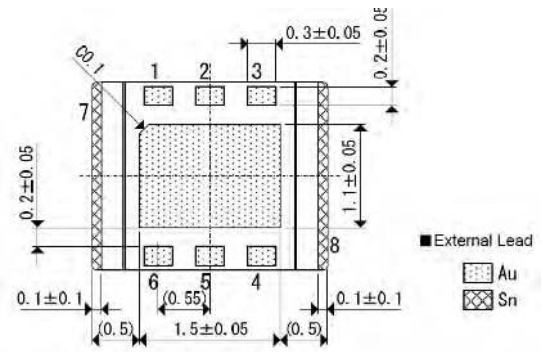
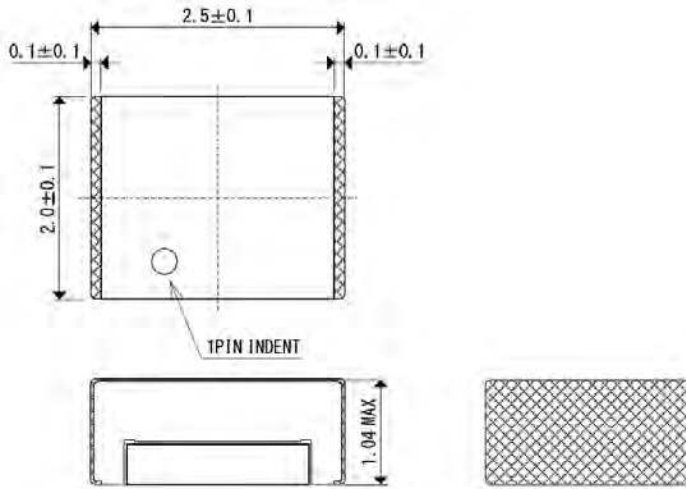

Reference Pattern Layout

Reference Metal Mask Design

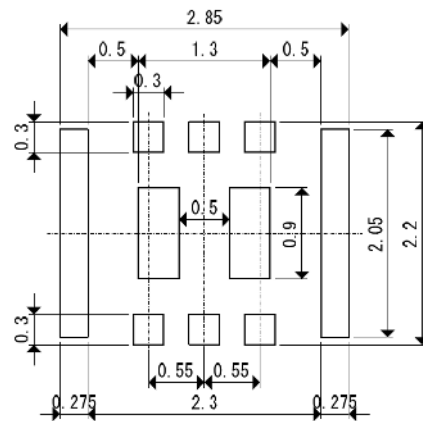
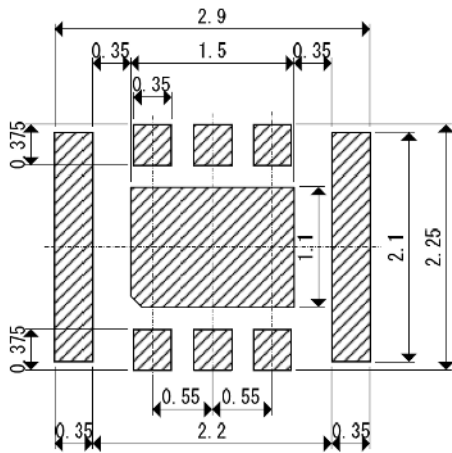

PACKAGE POWER DISSIPATION

CL-2025 Power Dissipation

The power dissipation varies with the mount board conditions. Please use this data as a reference only.

1. Measurement Conditions:

- Condition: Mount on a board
- Ambient: Natural convection
- Soldering: Lead (Pb) free
- Board: Dimensions 40x40 mm (1600 mm² in one side)
Copper (Cu) traces occupy 50% of the board area on top and bottom layers
Package heat sink tied to the copper traces.
- Material: Glass Epoxy (FR-4)
- Thickness: 1.6 mm
- Through-hole: 4 x 0.8 Diameter

2. Power Dissipation vs. Ambient Temperature
Board Mount (Tjmax = 125 °C)

Ambient Temperature, °C	Power Dissipation Pd, mW	Thermal Resistance, °C/W
25	1000	80
85	250	

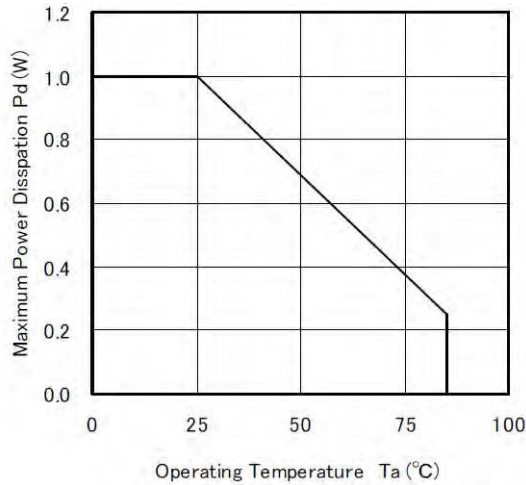
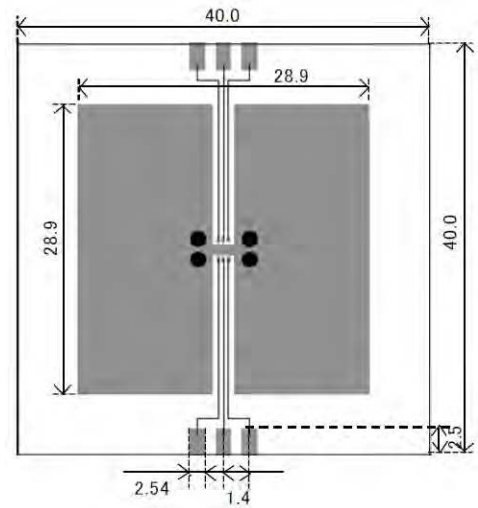

MARKING

CL-2025

① Represents product series

MARK	PRODUCT SERIES
F	IXD9201Bxxxxx-G
H	IXD9202Bxxxxx-G

② Represents integral part of the voltage value

OUTPUT VOLTAGE, V	MARK
	IXD920xBxx1xx-G
0.x	F
1.x	H
2.x	K
3.x	L
4.x	M

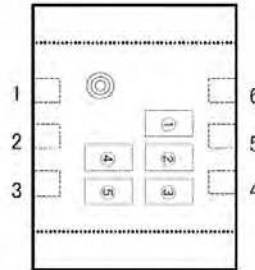

③ Represents decimal part of the Voltage value

V _{OUT} , V	MARK
x.00	0
x.05	A
x.10	1
x.15	B
x.20	2
x.25	C
x.30	3
x.35	D
x.40	4
x.45	E
x.50	5
x.55	F
x.60	6
x.65	H
x.70	7
x.75	K
x.80	8
x.85	L
x.90	9
x.95	M

④⑤ Represents production lot number

01~09, 0A~0Z, 11~9Z, A1~A9, AA~AZ, B1~ZZ in order
(G, I, J, O, Q, and W excluded)

Customer Support

To share comments, get your technical questions answered, or report issues you may be experiencing with our products, please visit Zilog's Technical Support page at <http://support.zilog.com>. To learn more about this product, find additional documentation, or to discover other facets about Zilog product offerings, please visit the Zilog Knowledge Base at <http://zilog.com/kb> or consider participating in the Zilog Forum at <http://zilog.com/forum>. This publication is subject to replacement by a later edition. To determine whether a later edition exists, please visit the Zilog website at <http://www.zilog.com>.

Warning: DO NOT USE THIS PRODUCT IN LIFE SUPPORT SYSTEMS.

LIFE SUPPORT POLICY ZILOG'S PRODUCTS ARE NOT AUTHORIZED FOR USE AS CRITICAL COMPONENTS IN LIFE SUPPORT DEVICES OR SYSTEMS WITHOUT THE EXPRESS PRIOR WRITTEN APPROVAL OF THE PRESIDENT AND GENERAL COUNSEL OF ZILOG CORPORATION.

As used herein Life support devices or systems are devices which (a) are intended for surgical implant into the body, or (b) support or sustain life and whose failure to perform when properly used in accordance with instructions for use provided in the labeling can be reasonably expected to result in a significant injury to the user. A critical component is any component in a life support device or system whose failure to perform can be reasonably expected to cause the failure of the life support device or system or to affect its safety or effectiveness.

Document Disclaimer ©2015 Zilog, Inc. All rights reserved. Information in this publication concerning the devices, applications, or technology described is intended to suggest possible uses and may be superseded. ZILOG, INC. DOES NOT ASSUME LIABILITY FOR OR PROVIDE A REPRESENTATION OF ACCURACY OF THE INFORMATION, DEVICES, OR TECHNOLOGY DESCRIBED IN THIS DOCUMENT. ZILOG ALSO DOES NOT ASSUME LIABILITY FOR INTELLECTUAL PROPERTY INFRINGEMENT RELATED IN ANY MANNER TO USE OF INFORMATION, DEVICES, OR TECHNOLOGY DESCRIBED HEREIN OR OTHERWISE. The information contained within this document has been verified according to the general principles of electrical and mechanical engineering.