

# MAXIM

## GSM900 and DCS1800/PCS1900 Dual-Band, Low-Noise Amplifiers

### General Description

The MAX2651/MAX2652/MAX2653 silicon germanium (SiGe), low-noise amplifiers (LNAs) are intended for use in GSM900, DCS1800, and PCS1900 band wireless handsets. The MAX2651/MAX2652 consist of two LNAs, one optimized for the GSM900 band and the other optimized for the DCS1800/PCS1900 bands. They feature a band-select pin to switch between the two LNAs, as well as a gain-step input to reduce the gain of each LNA by 20dB and reduce supply current. The MAX2652 is functionally equivalent to the MAX2651, but features a low-power shutdown mode. The MAX2653 consists of a single LNA optimized for the DCS1800 and PCS1900 bands, and has a shutdown feature and a 20dB gain step.

The MAX2652 and MAX2653 together form an ideal solution for triple-band phone applications (GSM, DCS, and PCS bands).

The MAX2651/MAX2652/MAX2653 are fabricated using an advanced high-frequency SiGe bipolar process. As a result, all devices provide low noise figure, high gain, and high input third-order intercept point (IP3) performance at the GSM, DCS, and PCS bands. A pull-up resistor to  $V_{CC}$  at each LNA output allows for gain adjustability. A minimal number of external components are needed for input and output matching, helping to reduce board space.

The MAX2651/MAX2652 are packaged in a 10-pin  $\mu$ MAX, while the MAX2653 is packaged in an 8-pin  $\mu$ MAX. All devices operate from a single +2.7V to +3.3V supply.

### Applications

GSM900/DCS1800 Dual-Band Phones

GSM900/DCS1800/PCS1900 Triple-Band Phones

DCS1800 or PCS1900 Single-Mode Phones

IS-136 TDMA Dual-Band Phones

### Features

- ◆ **Wide Operating Frequency Range**  
800MHz to 1000MHz (MAX2651/52)  
1800MHz to 2000MHz (MAX2651/52/53)
- ◆ **Excellent Low-Noise Performance**  
1.2dB/1.3dB over GSM Receive Band (MAX2651/52)  
1.8dB/1.8dB/1.7dB over DCS Receive Band (MAX2651/52/53)
- ◆ **High Gain**  
18dB over GSM Receive Band (MAX2651/52)  
18dB/17.5dB/18.5dB over DCS Receive Band (MAX2651/52/53)
- ◆ **20dB Gain Reduction in Low-Gain Mode**
- ◆ **Externally Adjustable Gain**
- ◆ **+2.7V to +3.3V Single-Supply Operation**
- ◆ **Low Supply Current**  
5.4mA to 7.0mA in High-Gain Mode  
2.2mA in Low-Gain Mode
- ◆ **0.25 $\mu$ A Shutdown Current (MAX2652/53)**

### Ordering Information

PART	TEMP RANGE	PIN-PACKAGE
MAX2651EUB	-40°C to +85°C	10 $\mu$ MAX
MAX2652EUB	-40°C to +85°C	10 $\mu$ MAX
MAX2653EUA	-40°C to +85°C	8 $\mu$ MAX

### Pin Configurations/Functional Diagrams

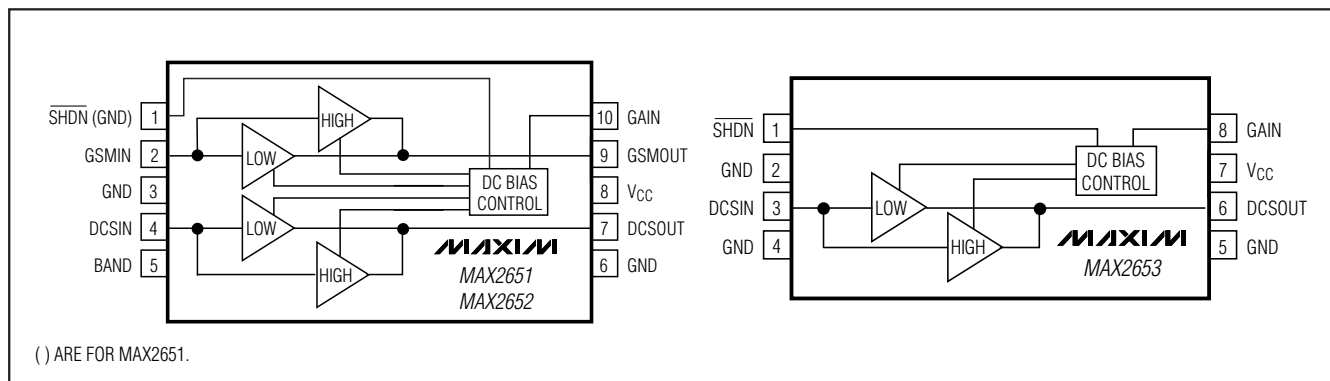

# GSM900 and DCS1800/PCS1900 Dual-Band, Low-Noise Amplifiers

## ABSOLUTE MAXIMUM RATINGS

V <sub>CC</sub> to GND .....	-0.3V to +6V	10-Pin μMAX (derate 5.6mW/°C above +70°C) .....	444mW
SHDN, GAIN, BAND to GND .....	-0.3V to (V <sub>CC</sub> + 0.3V)	Operating Temperature Range .....	-40°C to +85°C
GSMIN, DCSIN .....	1.0V peak (+10dBm)	Junction Temperature .....	+150°C
Input Current (all digital inputs) .....	±10mA	Storage Temperature Range .....	-65°C to +150°C
Continuous Power Dissipation		Lead Temperature (soldering, 10s) .....	+300°C
8-Pin μMAX (derate 4.5mW/°C above +70°C) .....	362mW		

Stresses beyond those listed under "Absolute Maximum Ratings" may cause permanent damage to the device. These are stress ratings only, and functional operation of the device at these or any other conditions beyond those indicated in the operational sections of the specifications is not implied. Exposure to absolute maximum rating conditions for extended periods may affect device reliability.



## DC ELECTRICAL CHARACTERISTICS—MAX2651

(V<sub>CC</sub> = +2.7V to +3.3V, BAND = GAIN = V<sub>CC</sub>, no input signal, all input/output ports terminated in 50Ω, T<sub>A</sub> = -40°C to +85°C, unless otherwise noted. Typical values are at V<sub>CC</sub> = +3V, T<sub>A</sub> = +25°C.) (Note 1)

PARAMETER	SYMBOL	CONDITIONS	MIN	TYP	MAX	UNITS
Input Voltage Range	V <sub>CC</sub>		2.7		3.3	V
Input Supply Current	I <sub>CC</sub>	DCS band, high-gain mode (BAND = GAIN = V <sub>CC</sub> )		5.7	8.7	mA
		DCS band, low-gain mode (BAND = V <sub>CC</sub> , GAIN = GND)		2.2	3.3	
		GSM band, high-gain mode (BAND = GND, GAIN = V <sub>CC</sub> )		5.9	9.6	
		GSM band, low-gain mode (BAND = GND, GAIN = V <sub>CC</sub> )		2.2	3.6	
Input Logic Threshold High	V <sub>IH</sub>				1.5	V
Input Logic Threshold Low	V <sub>IL</sub>		0.5			V
Input Logic High Current	I <sub>IH</sub>	V <sub>IN</sub> = V <sub>CC</sub>			1.5	μA
Input Logic Low Current	I <sub>IL</sub>	V <sub>IN</sub> = GND	-1.5			μA

## DC ELECTRICAL CHARACTERISTICS—MAX2652

(V<sub>CC</sub> = +2.7V to +3.3V, BAND = GAIN = V<sub>CC</sub>, no input signal, all input/output ports terminated in 50Ω, T<sub>A</sub> = -40°C to +85°C, unless otherwise noted. Typical values are at V<sub>CC</sub> = +3V, T<sub>A</sub> = +25°C.) (Note 1)

PARAMETER	SYMBOL	CONDITIONS	MIN	TYP	MAX	UNITS
Input Voltage Range	V <sub>CC</sub>		2.7		3.3	V
Input Supply Current	I <sub>CC</sub>	DCS band, high-gain mode (BAND = GAIN = V <sub>CC</sub> )		7.0	11.0	mA
		DCS band, low-gain mode (BAND = V <sub>CC</sub> , GAIN = GND)		2.3	3.6	
		GSM band, high-gain mode (BAND = GND, GAIN = V <sub>CC</sub> )		7.2	11.0	
		GSM band, low-gain mode (BAND = GND, GAIN = V <sub>CC</sub> )		2.4	3.7	
Shutdown Supply Current		SHDN = GND		0.25		μA

# GSM900 and DCS1800/PCS1900 Dual-Band, Low-Noise Amplifiers

**MAX2651/MAX2652/MAX2653**

## DC ELECTRICAL CHARACTERISTICS—MAX2653

( $V_{CC} = +2.7V$  to  $+3.3V$ ,  $\overline{SHDN} = GAIN = V_{CC}$ , no input signal, all input/output ports terminated in  $50\Omega$ ,  $T_A = -40^\circ C$  to  $+85^\circ C$ , unless otherwise noted. Typical values are at  $V_{CC} = +3V$ ,  $T_A = +25^\circ C$ .) (Note 1)

PARAMETER	SYMBOL	CONDITIONS	MIN	TYP	MAX	UNITS
Input Logic Threshold High	$V_{IH}$				1.5	V
Input Logic Threshold Low	$V_{IL}$		0.5			V
Input Logic High Current	$I_{IH}$	$V_{IN} = V_{CC}$			1.5	$\mu A$
Input Logic Low Current	$I_{IL}$	$V_{IN} = GND$	-1.5			$\mu A$
Input Voltage Range	$V_{CC}$		2.7		3.3	V
Input Supply Current	$I_{CC}$	DCS band, high-gain mode ( $GAIN = V_{CC}$ )		5.4	8.5	mA
		DCS band, low-gain mode ( $GAIN = GND$ )		2.2	3.2	
Shutdown Supply Current	$I_{SHDN}$	$\overline{SHDN} = GND$		0.25		$\mu A$
Input Logic Threshold High	$V_{IH}$				1.5	V
Input Logic Threshold Low	$V_{IL}$		0.5			V
Input Logic High Current	$I_{IH}$	$V_{IN} = V_{CC}$			3	$\mu A$
Input Logic Low Current	$I_{IL}$	$V_{IN} = GND$	-1.5			$\mu A$

**Note 1:** Devices are production tested at  $T_A = +25^\circ C$ . Minimum and maximum limits are guaranteed by design and characterization.

## AC ELECTRICAL CHARACTERISTICS—MAX2651

(MAX2651 EV kit,  $f_{IN} = 945MHz$  (GSM band),  $f_{IN} = 1850MHz$  (DCS band),  $P_{IN} = -30dBm$ , input and output matching networks are optimized for the frequency band of interest, all input/output ports terminated in  $50\Omega$ ,  $V_{CC} = +3V$ ,  $T_A = +25^\circ C$ , unless otherwise noted.) (Note 2)

PARAMETER	SYMBOL	CONDITIONS	MIN	TYP	MAX	UNITS	
Input Frequency Range (Note 3)	$f_{IN}$	DCS band ( $BAND = V_{CC}$ )	1805		1880	MHz	
		GSM band ( $BAND = GND$ )	925		960		
Power Gain (Note 4)	G	DCS band, high-gain mode ( $BAND = GAIN = V_{CC}$ )	$T_A = +25^\circ C$	16.5	18	19.5	dB
			$T_A = -40^\circ C$ to $+85^\circ C$	16		20	
		DCS band, low-gain mode ( $BAND = V_{CC}$ , $GAIN = GND$ )	$T_A = +25^\circ C$	-3.5	-2	-0.5	
			$T_A = -40^\circ C$ to $+85^\circ C$	-4		0	
		GSM band, high-gain mode ( $BAND = GND$ , $GAIN = V_{CC}$ )	$T_A = +25^\circ C$	16.5	18	19.5	
			$T_A = -40^\circ C$ to $+85^\circ C$	16		20	
GSM band, low-gain mode ( $BAND = GAIN = GND$ )	$T_A = +25^\circ C$	-3.5	-2	-0.5			
	$T_A = -40^\circ C$ to $+85^\circ C$	-4		0			
Noise Figure (Note 4)	NF	DCS band, high-gain mode ( $BAND = GAIN = V_{CC}$ )			1.8	2.05	dB
		DCS band, low-gain mode ( $BAND = V_{CC}$ , $GAIN = GND$ )			5.5	6.0	
		GSM band, high-gain mode ( $BAND = GND$ , $GAIN = V_{CC}$ )			1.2	1.4	
		GSM band, low-gain mode ( $BAND = GAIN = GND$ )			5.3	6.7	

# GSM900 and DCS1800/PCS1900 Dual-Band, Low-Noise Amplifiers

## AC ELECTRICAL CHARACTERISTICS—MAX2651 (continued)

(MAX2651 EV kit,  $f_{IN} = 945\text{MHz}$  (GSM band),  $f_{IN} = 1850\text{MHz}$  (DCS band),  $P_{IN} = -30\text{dBm}$ , input and output matching networks are optimized for the frequency band of interest, all input/output ports terminated in  $50\Omega$ ,  $V_{CC} = +3\text{V}$ ,  $T_A = +25^\circ\text{C}$ , unless otherwise noted.) (Note 2)

PARAMETER	SYMBOL	CONDITIONS	MIN	TYP	MAX	UNITS
Input Third-Order Intercept Point	IIP3	(Note 5) DCS band, high-gain mode (BAND = GAIN = V <sub>CC</sub> )	-11.5	-10		dBm
		DCS band, low-gain mode (BAND = V <sub>CC</sub> , GAIN = GND)	-1.5	0.5		
		(Note 6) GSM band, high-gain mode (BAND = GND, GAIN = V <sub>CC</sub> )	-10.5	-8.5		
		GSM band, low-gain mode (BAND = GND, GAIN = GND)	-2.5	0.5		
Input 1dB Compression Point	IP-1dB	DCS band, high-gain mode (BAND = GAIN = V <sub>CC</sub> )	-20	-18		dBm
		DCS band, low-gain mode (BAND = V <sub>CC</sub> , GAIN = GND)	-9.5	-8		
		GSM band, high-gain mode (BAND = GND, GAIN = V <sub>CC</sub> )	-20	-18		
		GSM band, low-gain mode (BAND = GND, GAIN = GND)	-10.5	-8.5		
Input Return Loss	$ S_{11} ^2$	DCS band, high-gain mode (BAND = GAIN = V <sub>CC</sub> )		-11	-8.5	dB
		DCS band, low-gain mode (BAND = V <sub>CC</sub> , GAIN = GND)		-14	-12	
		GSM band, high-gain mode (BAND = GND, GAIN = V <sub>CC</sub> )		-11	-8.5	
		GSM band, low-gain mode (BAND = GAIN = GND)		-20	-15	
Output Return Loss	$ S_{22} ^2$	DCS band, high-gain mode (BAND = GAIN = V <sub>CC</sub> )		-14	-10	dB
		DCS band, low-gain mode (BAND = V <sub>CC</sub> , GAIN = GND)		-12	-10	
		GSM band, high-gain mode (BAND = GND, GAIN = V <sub>CC</sub> )		-19	-15	
		GSM band, low-gain mode (BAND = GAIN = GND)		-20	-15	
Reverse Isolation	$ S_{12} ^2$	DCS band, high-gain mode (BAND = GAIN = V <sub>CC</sub> )		-32	-29	dB
		DCS band, low-gain mode (BAND = V <sub>CC</sub> , GAIN = GND)		-20	-18	
		GSM band, high-gain mode (BAND = GND, GAIN = V <sub>CC</sub> )		-39	-35	
		GSM band, low-gain mode (BAND = GAIN = GND)		-22	-20	

# GSM900 and DCS1800/PCS1900 Dual-Band, Low-Noise Amplifiers

## AC ELECTRICAL CHARACTERISTICS—MAX2652

(MAX2652 EV kit,  $f_{IN} = 945\text{MHz}$  (GSM band),  $f_{IN} = 1850\text{MHz}$  (DCS band),  $P_{IN} = -30\text{dBm}$ , input and output matching networks are optimized for the frequency band of interest, all input/output ports terminated in  $50\Omega$ ,  $V_{CC} = +3\text{V}$ ,  $T_A = +25^\circ\text{C}$ , unless otherwise noted.) (Note 2)

PARAMETER	SYMBOL	CONDITIONS		MIN	TYP	MAX	UNITS
Input Frequency Range (Note 3)	$f_{IN}$	DCS band (BAND = $V_{CC}$ )		1805		1880	MHz
		GSM band (BAND = GND)		925		960	
Power Gain (Note 4)	G	DCS band, high-gain mode (BAND = GAIN = $V_{CC}$ )	$T_A = +25^\circ\text{C}$	16	17.5	19	dB
			$T_A = -40^\circ\text{C}$ to $+85^\circ\text{C}$	15.5		19.5	
		DCS band, low-gain mode (BAND = $V_{CC}$ , GAIN = GND)	$T_A = +25^\circ\text{C}$	-3.5	-2	-0.5	
			$T_A = -40^\circ\text{C}$ to $+85^\circ\text{C}$	-4		0	
		GSM band, high-gain mode (BAND = GND, GAIN = $V_{CC}$ )	$T_A = +25^\circ\text{C}$	16.5	18	19.5	
			$T_A = -40^\circ\text{C}$ to $+85^\circ\text{C}$	16		20	
GSM band, low-gain mode (BAND = GAIN = GND)	$T_A = +25^\circ\text{C}$	-4.0	-2	-0.5			
	$T_A = -40^\circ\text{C}$ to $+85^\circ\text{C}$	-4.5		0			
Noise Figure (Note 4)	NF	DCS band, high-gain mode (BAND = GAIN = $V_{CC}$ )			1.8	2.0	dB
		DCS band, low-gain mode (BAND = $V_{CC}$ , GAIN = GND)			5.8	6.3	
		GSM band, high-gain mode (BAND = GND, GAIN = $V_{CC}$ )			1.3	1.5	
		GSM band, low-gain mode (BAND = GAIN = GND)			5.5	6.7	
Input Third-Order Intercept Point	IIP3	(Note 5)	DCS band, high-gain mode (BAND = GAIN = $V_{CC}$ )	-8.5	-7		dBm
			DCS band, low-gain mode (BAND = $V_{CC}$ , GAIN = GND)	0	1.5		
		(Note 6)	GSM band, high-gain mode (BAND = GND, GAIN = $V_{CC}$ )	-9	-7.5		
			GSM band, low-gain mode (BAND = GND, GAIN = GND)	0.5	2.5		
Input 1dB Compression Point	IP-1dB	DCS band, high-gain mode (BAND = GAIN = $V_{CC}$ )		-18	-16.5		dBm
		DCS band, low-gain mode (BAND = $V_{CC}$ , GAIN = GND)		-10.5	-8		
		GSM band, high-gain mode (BAND = GND, GAIN = $V_{CC}$ )		-18	-16.5		
		GSM band, low-gain mode (BAND = GND, GAIN = GND)		-10	-8.5		

MAX2651/MAX2652/MAX2653

# GSM900 and DCS1800/PCS1900 Dual-Band, Low-Noise Amplifiers

## AC ELECTRICAL CHARACTERISTICS—MAX2652 (continued)

(MAX2652 EV kit,  $f_{IN} = 945\text{MHz}$  (GSM band),  $f_{IN} = 1850\text{MHz}$  (DCS band),  $P_{IN} = -30\text{dBm}$ , input and output matching networks are optimized for the frequency band of interest, all input/output ports terminated in  $50\Omega$ ,  $V_{CC} = +3\text{V}$ ,  $T_A = +25^\circ\text{C}$ , unless otherwise noted.) (Note 2)

PARAMETER	SYMBOL	CONDITIONS	MIN	TYP	MAX	UNIT
Input Return Loss	$ S_{11} ^2$	DCS band, high-gain mode (BAND = GAIN = $V_{CC}$ )		-12	-9.5	dB
		DCS band, low-gain mode (BAND = $V_{CC}$ , GAIN = GND)		-12	-9.5	
		GSM band, high-gain mode (BAND = GND, GAIN = $V_{CC}$ )		-11	-9.5	
		GSM band, low-gain mode (BAND = GAIN = GND)		-20	-15	
Output Return Loss	$ S_{22} ^2$	DCS band, high-gain mode (BAND = GAIN = $V_{CC}$ )		-11	-9.5	dB
		DCS band, low-gain mode (BAND = $V_{CC}$ , GAIN = GND)		-17	-13	
		GSM band, high-gain mode (BAND = GND, GAIN = $V_{CC}$ )		-12.5	-11	
		GSM band, low-gain mode (BAND = GAIN = GND)		-15	-13	
Reverse Isolation	$ S_{12} ^2$	DCS band, high-gain mode (BAND = GAIN = $V_{CC}$ )		-29	-26	dB
		DCS band, low-gain mode (BAND = $V_{CC}$ , GAIN = GND)		-19	-17	
		GSM band, high-gain mode (BAND = GND, GAIN = $V_{CC}$ )		-37	-34	
		GSM band, low-gain mode (BAND = GAIN = GND)		-23	-20	

# GSM900 and DCS1800/PCS1900 Dual-Band, Low-Noise Amplifiers

**MAX2651/MAX2652/MAX2653**

## AC ELECTRICAL CHARACTERISTICS—MAX2653

(MAX2653 EV kit,  $f_{IN} = 1850\text{MHz}$  (DCS band),  $f_{IN} = 1960\text{MHz}$  (PCS band),  $P_{IN} = -30\text{dBm}$ , input and output matching networks are optimized for the frequency band of interest, all input/output ports terminated in  $50\Omega$ ,  $V_{CC} = +3\text{V}$ ,  $T_A = +25^\circ\text{C}$ , unless otherwise noted.) (Note 2)

PARAMETER	SYMBOL	CONDITIONS		MIN	TYP	MAX	UNITS
Input Frequency Range (Note 3)	$f_{IN}$	BAND = $V_{CC}$	DCS band	1805		1880	MHz
			PCS band	1930		1990	
Power Gain (Note 4)	G	DCS and PCS band, high-gain mode (BAND = GAIN = $V_{CC}$ )	$T_A = +25^\circ\text{C}$	17	18.5	20	dB
			$T_A = -40^\circ\text{C}$ to $+85^\circ\text{C}$	16		20	
		DCS and PCS band, low-gain mode (BAND = $V_{CC}$ , GAIN = GND)	$T_A = +25^\circ\text{C}$	-4	-2.5	-1	
			$T_A = -40^\circ\text{C}$ to $+85^\circ\text{C}$	-4		0	
Noise Figure (Note 4)	NF	High-gain mode (BAND = GAIN = $V_{CC}$ )	DCS band		1.7	1.9	dB
			PCS band		1.8	2.05	
		DCS and PCS band, low-gain mode (BAND = $V_{CC}$ , GAIN = GND)			5.3	6.7	
Input Third-Order Intercept Point (Notes 5, 7)	IIP3	DCS and PCS band, high-gain mode (BAND = $V_{CC}$ , GAIN = GND)		-10.5	-8.5		dBm
		DCS and PCS band, low-gain mode (BAND = $V_{CC}$ , GAIN = GND)		-1	+1.5		
Input 1dB Compression Point	IP-1dB	DCS and PCS band, high-gain mode (BAND = GAIN = $V_{CC}$ )		-20	-18		dB
		DCS and PCS band, low-gain mode (BAND = $V_{CC}$ , GAIN = GND)		-9	-7		
Input Return Loss	$ S_{11} ^2$	DCS and PCS band, high-gain mode (BAND = GAIN = $V_{CC}$ )			-11	-8.5	dB
		DCS and PCS band, low-gain mode (BAND = $V_{CC}$ , GAIN = GND)			-11	-9.5	
Output Return Loss	$ S_{22} ^2$	DCS and PCS band, high-gain mode (BAND = GAIN = $V_{CC}$ )			-12	-9.5	dB
		DCS and PCS band, low-gain mode (BAND = $V_{CC}$ , GAIN = GND)			-15	-12	
Reverse Isolation	$ S_{12} ^2$	High-gain mode (BAND = GAIN = $V_{CC}$ )	DCS band		-35	-31	dB
			PCS band		-33	-29	
		Low-gain mode (BAND = $V_{CC}$ , GAIN = GND)	DCS band		-21	-18	
			PCS band		-21	-18	

**Note 2:** Minimum and maximum limits are guaranteed by design and characterization, but not production tested.

**Note 3:** The part has been fully characterized at the specified frequency range. Operation outside of this range is possible but not guaranteed.

**Note 4:** Specification excludes circuit board losses.

**Note 5:** Measured with two tones,  $f_{IN1} = 1850\text{MHz}$ ,  $f_{IN2} = 1850.8\text{MHz}$ ,  $P_{IN} = -33\text{dBm}$  for each tone.

**Note 6:** Measured with two tones,  $f_{IN1} = 945\text{MHz}$ ,  $f_{IN2} = 945.8\text{MHz}$ ,  $P_{IN} = -33\text{dBm}$  for each tone.

**Note 7:** Measured with two tones,  $f_{IN1} = 1960\text{MHz}$ ,  $f_{IN2} = 1960.8\text{MHz}$ ,  $P_{IN} = -33\text{dBm}$  for each tone.

# GSM900 and DCS1800/PCS1900 Dual-Band, Low-Noise Amplifiers

## Typical Operating Characteristics

(MAX2651 EV kit,  $V_{CC} = +3.0V$ , input and output matched with recommended matching networks,  $T_A = +25^\circ C$ , unless otherwise noted.)

### MAX2651 (GSM Band)

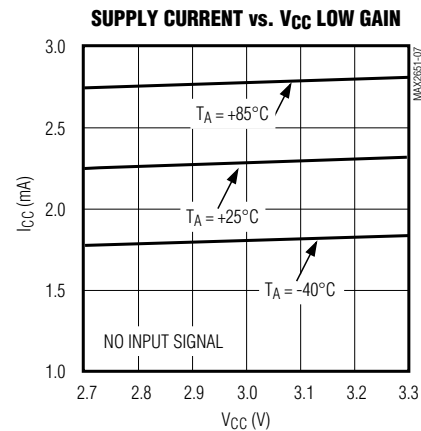
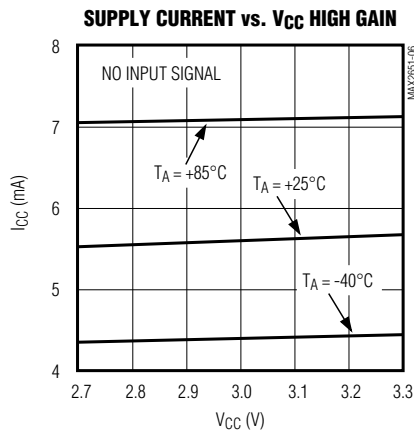
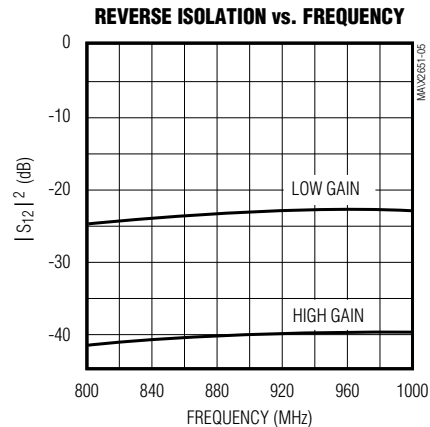
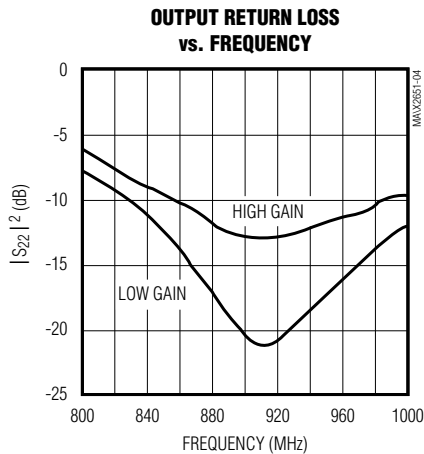
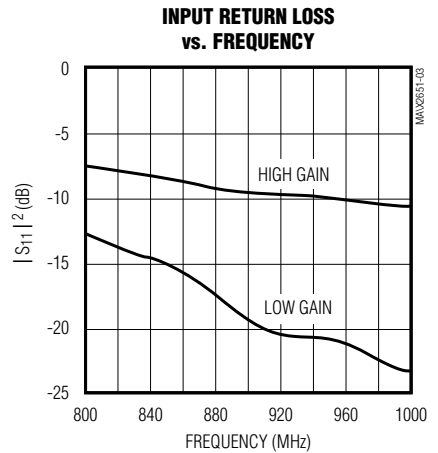
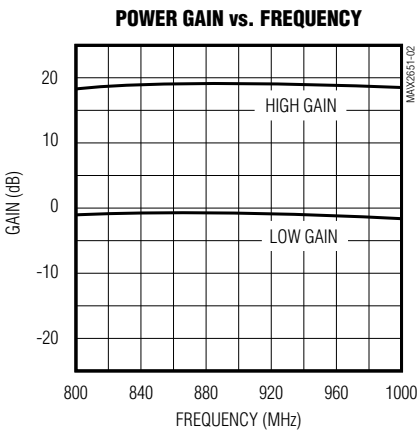
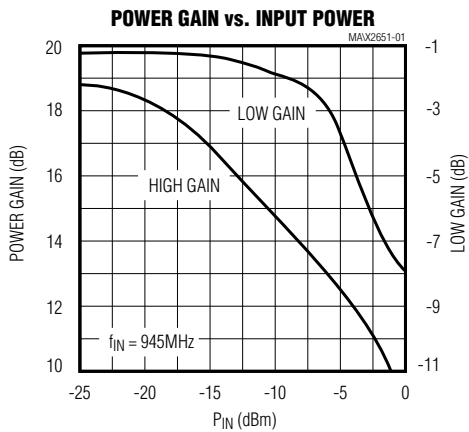



# GSM900 and DCS1800/PCS1900 Dual-Band, Low-Noise Amplifiers

## Typical Operating Characteristics (continued)

(MAX2651 EV kit,  $V_{CC} = +3.0V$ , input and output matched with recommended matching networks,  $T_A = +25^\circ C$ , unless otherwise noted.)

### MAX2651 (DCS Band)

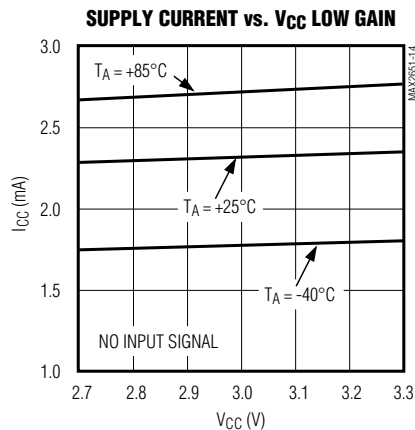
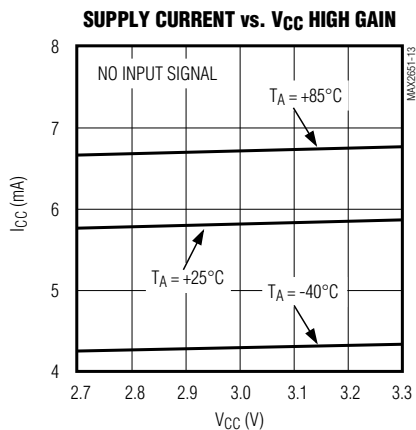
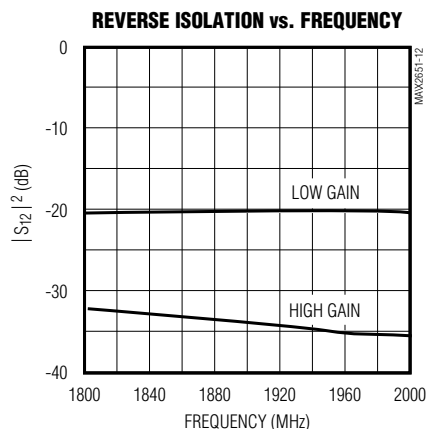
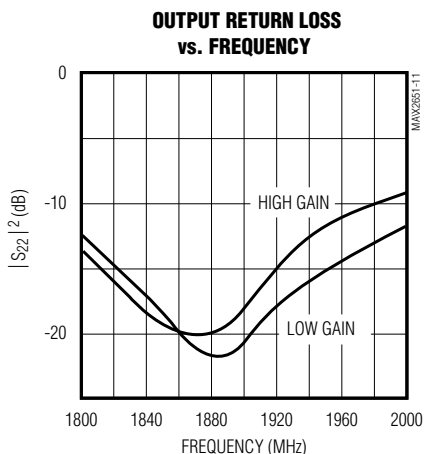
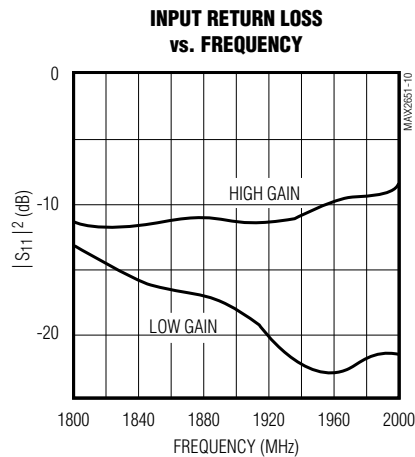
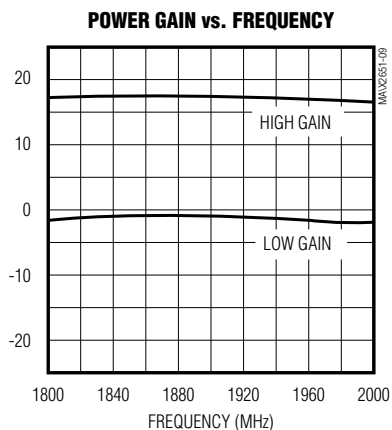
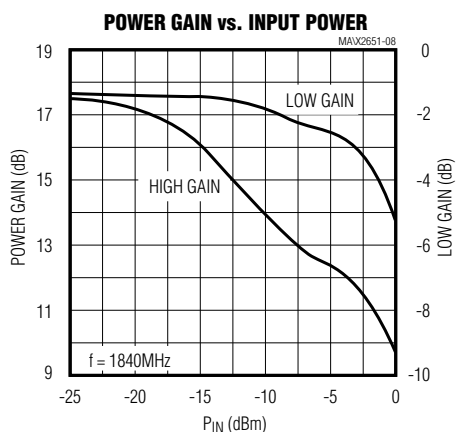

MAX2651/MAX2652/MAX2653

# GSM900 and DCS1800/PCS1900 Dual-Band, Low-Noise Amplifiers

## Typical Operating Characteristics (continued)

(MAX2652 EV kit,  $V_{CC} = +3.0V$ , input and output matched with recommended matching networks,  $T_A = +25^\circ C$ , unless otherwise noted.)

### MAX2652 (GSM Band)

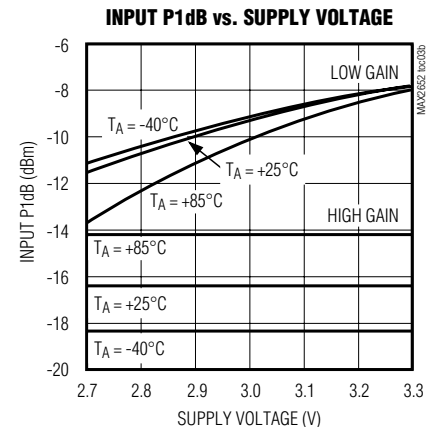
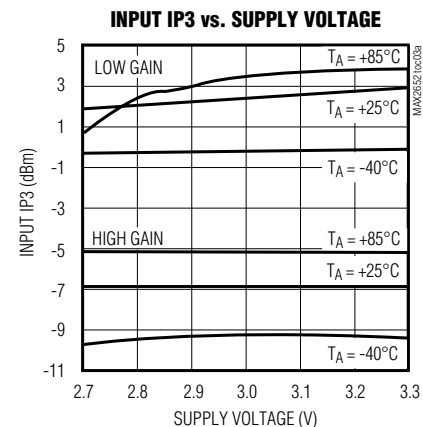
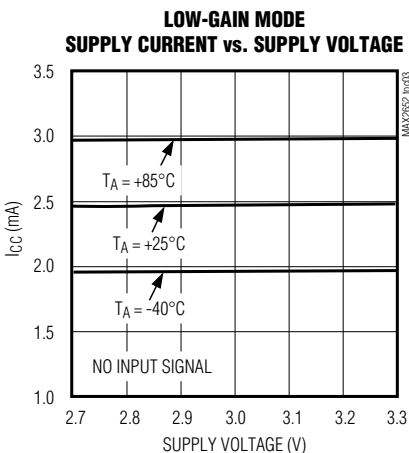
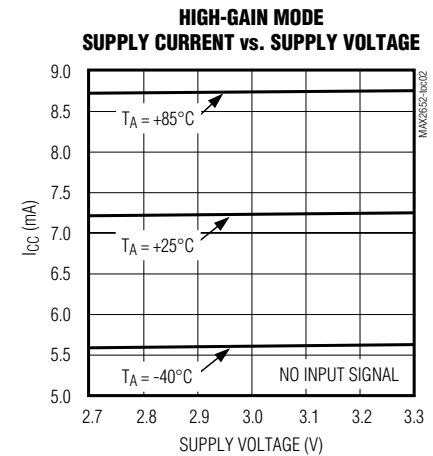
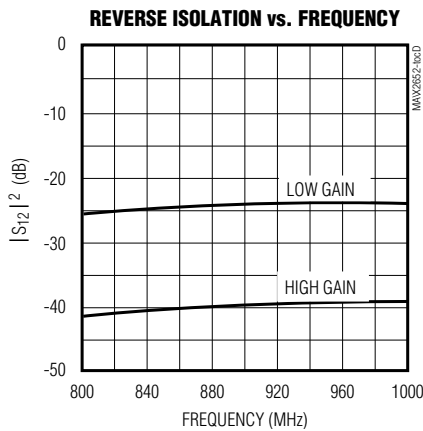
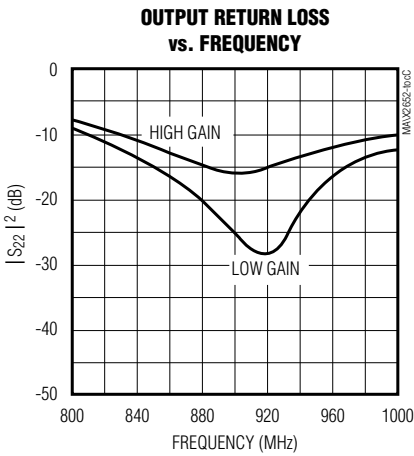
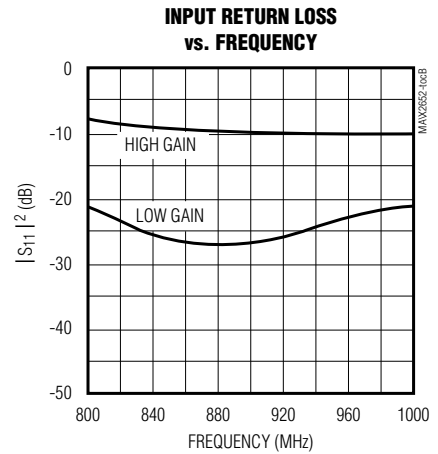
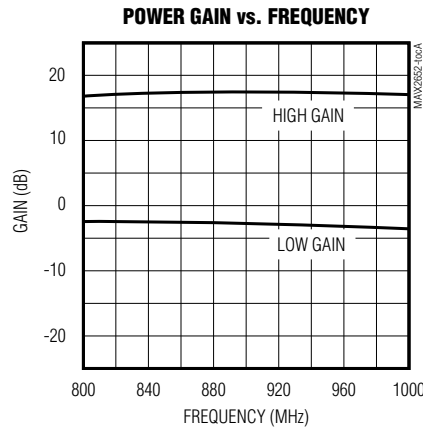
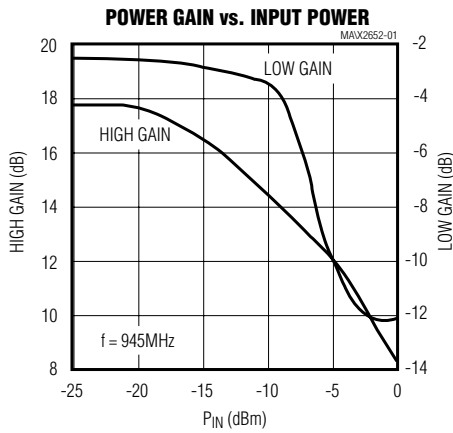

# GSM900 and DCS1800/PCS1900 Dual-Band, Low-Noise Amplifiers

## Typical Operating Characteristics (continued)

(MAX2652 EV kit,  $V_{CC} = +3.0V$ , input and output matched with recommended matching networks,  $T_A = +25^\circ C$ , unless otherwise noted.)

### MAX2652 (DCS Band)

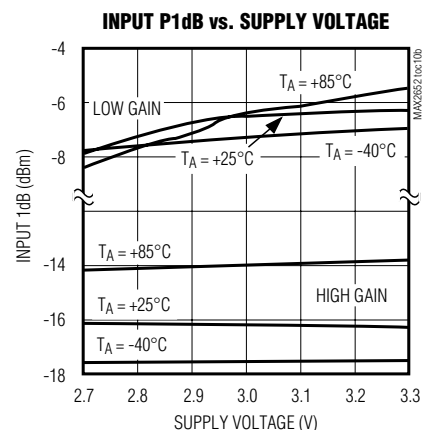
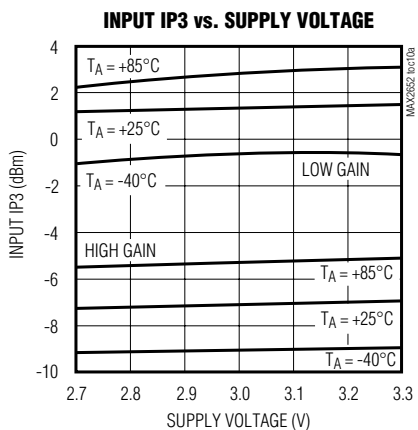
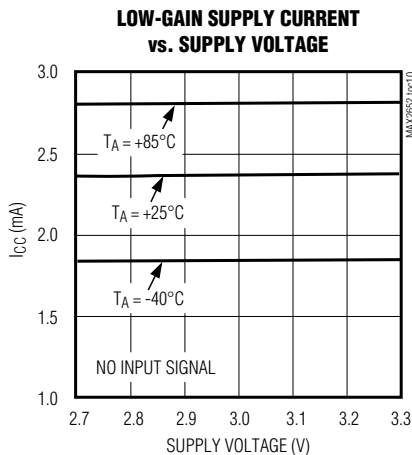
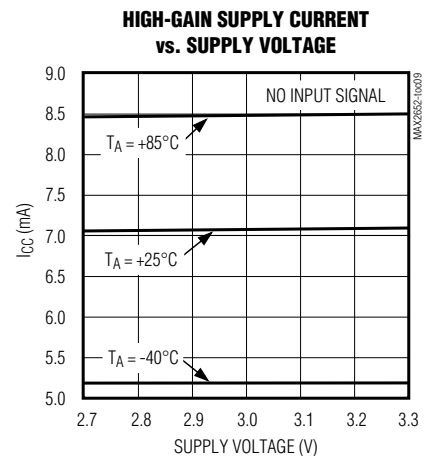
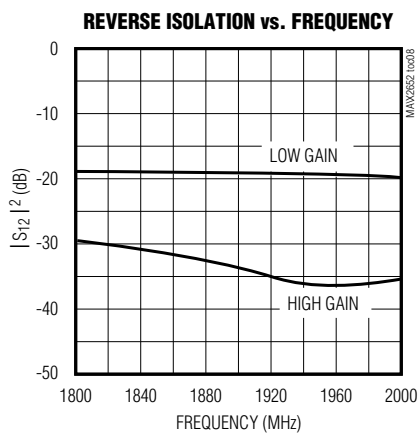
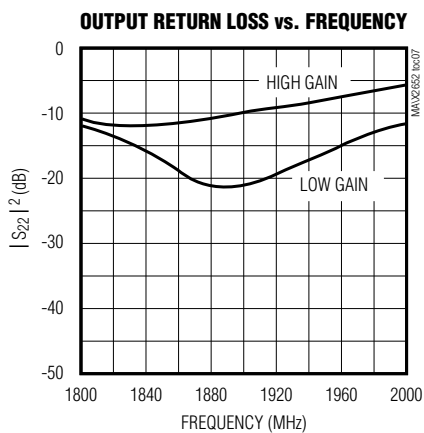
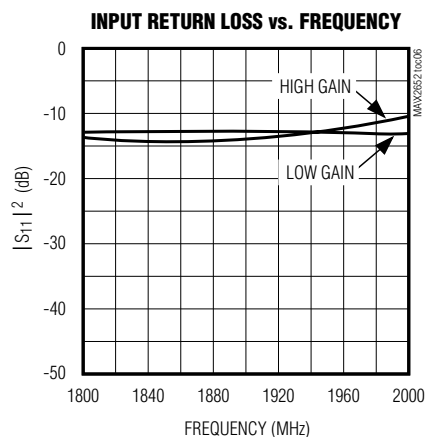
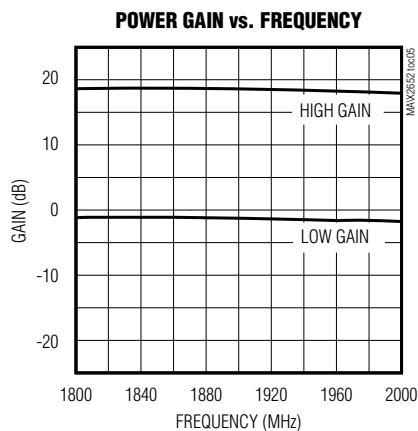
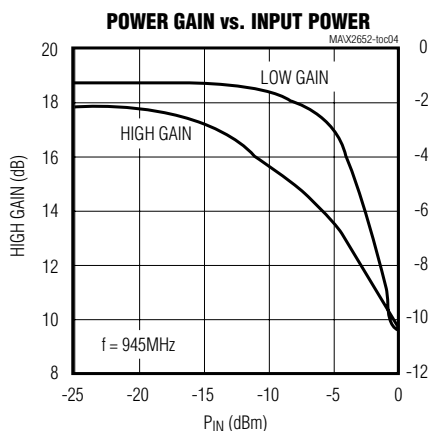

MAX2651/MAX2652/MAX2653

# GSM900 and DCS1800/PCS1900 Dual-Band, Low-Noise Amplifiers

## Typical Operating Characteristics (continued)

(MAX2653 EV kit,  $V_{CC} = +3.0V$ , input and output matched with recommended matching networks,  $T_A = +25^\circ C$ , unless otherwise noted.)

### MAX2653 (DCS Band)

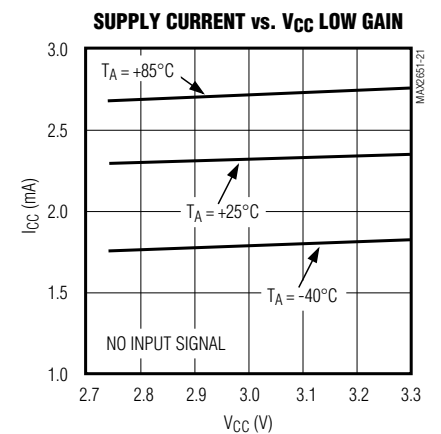
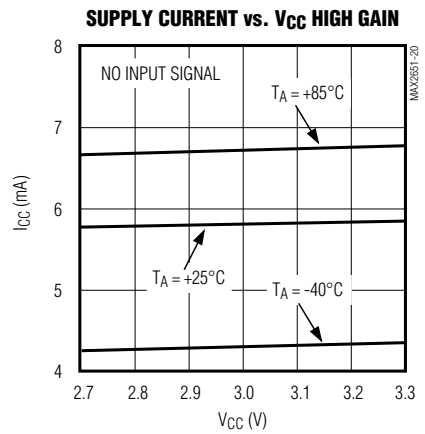
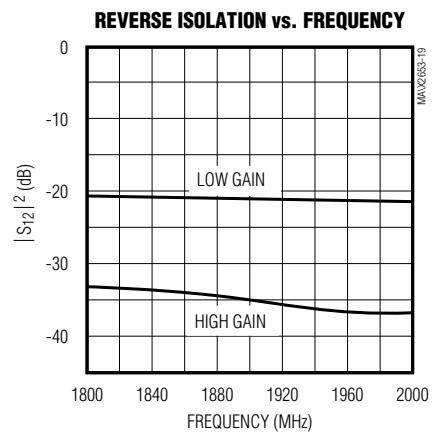
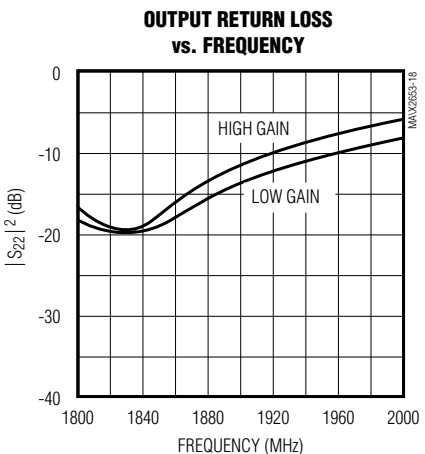
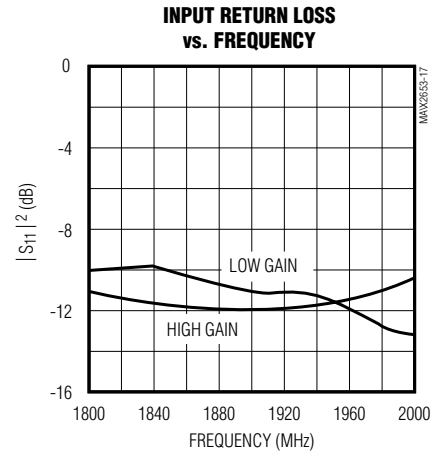
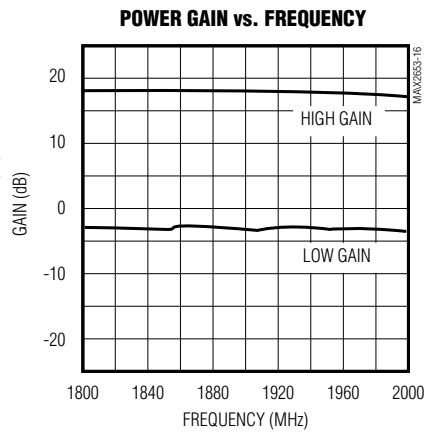
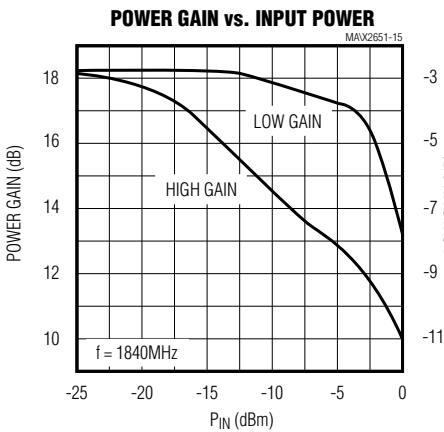

# GSM900 and DCS1800/PCS1900 Dual-Band, Low-Noise Amplifiers

## Pin Description

PIN			NAME	FUNCTION
MAX2651	MAX2652	MAX2653		
—	1	1	$\overline{\text{SHDN}}$	Shutdown Logic Input. Drive low to enter shutdown; drive high or connect to $V_{CC}$ for normal operation.
1, 3, 6	3, 6	2, 4, 5	GND	RF Ground. Connect to the ground plane as close to the IC as possible to minimize trace inductance.
2	2	—	GSMIN	RF Input for GSM Band
4	4	3	DCSIN	RF Input for DCS and PCS bands
5	5	—	BAND	Band-Select Logic Input. Drive BAND high to enable DCS/PCS LNA; drive low to enable GSM LNA.
7	7	6	DCSOUT	RF Output for DCS and PCS Bands
8	8	7	$V_{CC}$	Supply Voltage Input, $+2.7V < V_{CC} < +3.3V$
9	9	—	GSMOUT	RF Output for GSM Band
10	10	8	GAIN	Gain-Select Logic Input. Drive GAIN high for high-gain operation; drive GAIN low for low-gain operation.

MAX2651/MAX2652/MAX2653

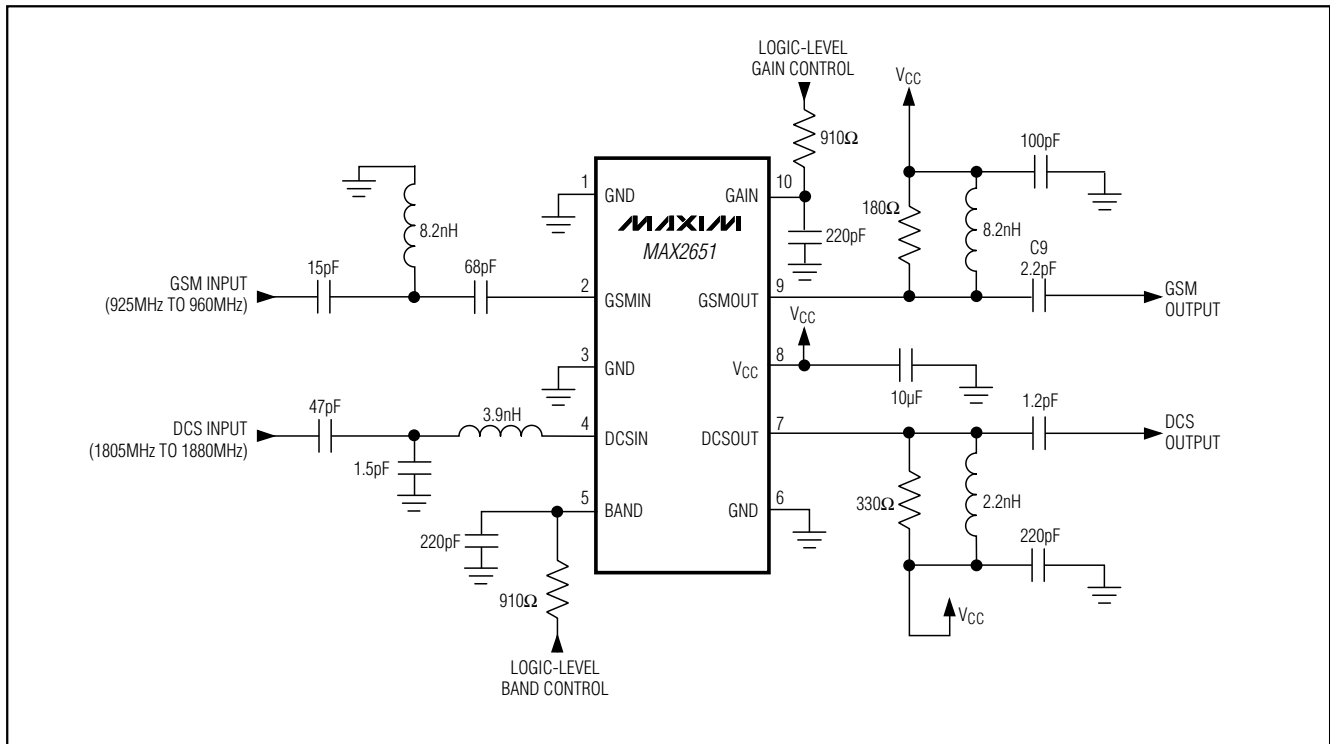

Figure 1. MAX2651 Typical Application Circuit

# GSM900 and DCS1800/PCS1900 Dual-Band, Low-Noise Amplifiers

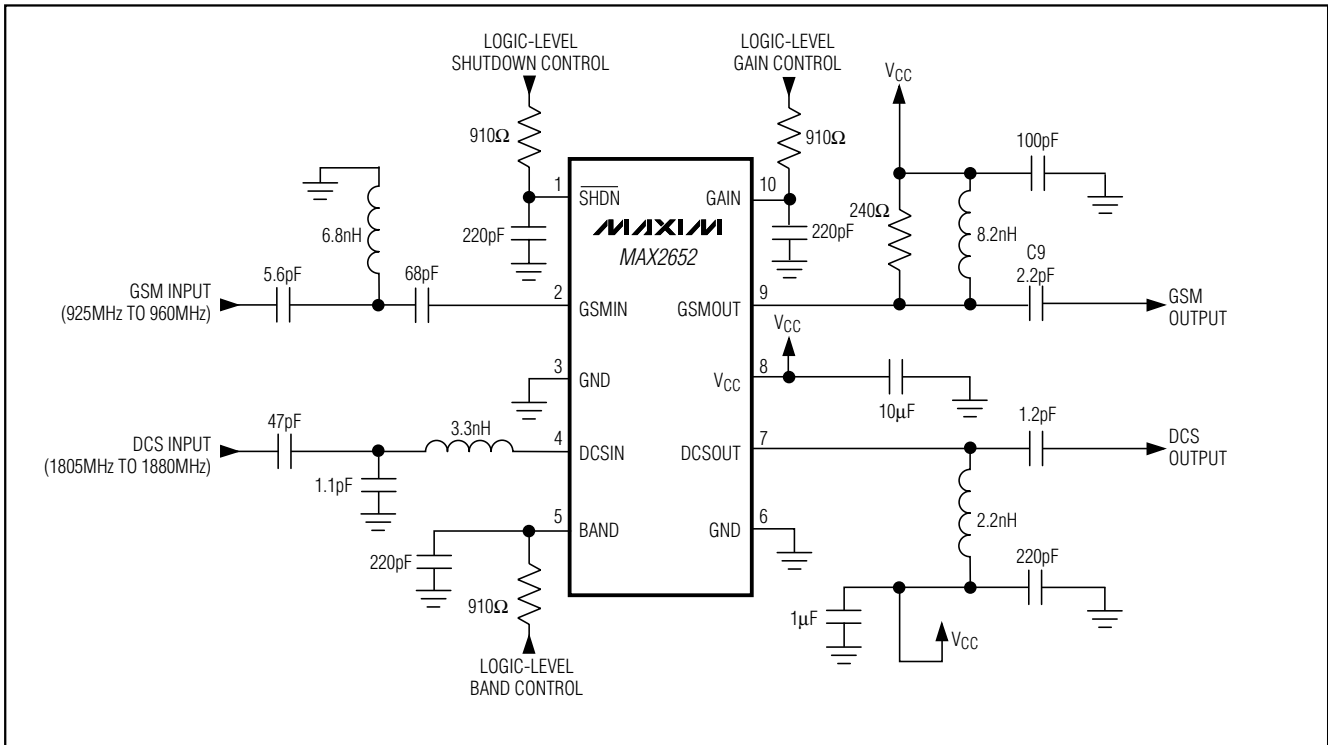

Figure 2. MAX2652 Typical Application Circuit

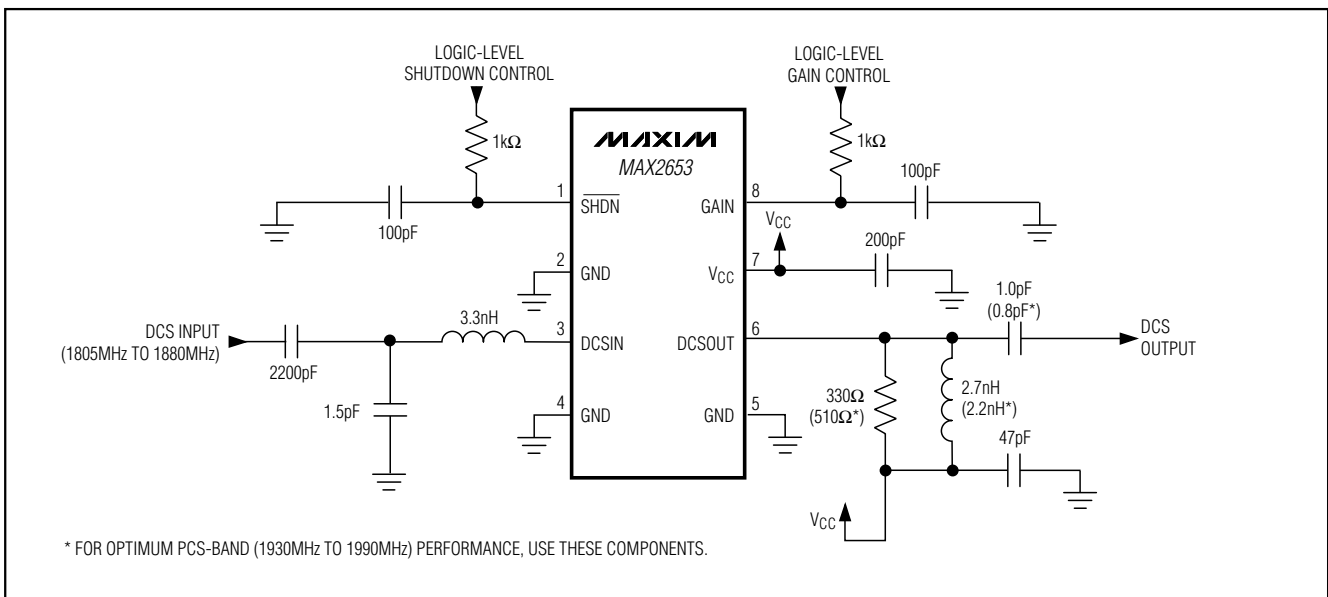

Figure 3. MAX2653 Typical Application Circuit

# GSM900 and DCS1800/PCS1900 Dual-Band, Low-Noise Amplifiers

## Detailed Description

### Gain Select

The MAX2651/MAX2652/MAX2653 offer a step gain in the LNA to optimize the receiver's dynamic range. A logic-level low at GAIN reduces the active LNA's gain by about 20dB and reduces supply current by 3.5mA.

### Shutdown Functionality

The MAX2652/MAX2653 offer a low-current shutdown feature. Drive SHDN low to power down the LNA and reduce supply current to less than 0.25 $\mu$ A.

## Applications Information

### External Components

The MAX2651/MAX2652/MAX2653 require matching circuits at their inputs and outputs for operation in a 50 $\Omega$  system. The application circuits in Figures 1, 2, and 3 describe the matching circuits for each device's LNA; suggested component values, suppliers, and part numbers are listed in the MAX2651/MAX2652/MAX2653 EV kits manual. These values are optimized for best simultaneous noise figure, gain, and return loss performance.

Input and output impedance matching networks are very sensitive to layout-related parasitics. It is important to keep all matching components as close to the device as possible to minimize the effects of stray inductance and stray capacitance of PC board traces, particularly for the 1800MHz and 1900MHz bands.

### Using the Collector Load Resistor to Set Gain

The MAX2651/MAX2652/MAX2653 provide open-collector output stages to allow an external resistor to set the gain. The collector pull-up resistors set the gain for each LNA to about 18dB. Lower gains are achieved by reducing this resistance, and higher gains are achieved by increasing it. The maximum achievable gain is defined by the maximum collector current swing. Note that the value of the collector gain-setting resistor principally defines the LNA's output impedance, and that the matching networks are tuned to match this impedance to 50 $\Omega$ . Redefining the LNA gain by changing the collector gain-setting resistor requires retuning the output matching networks.

### Layout and Power-Supply Bypassing

A properly designed PC board is essential to any RF/microwave circuit. Be sure to use controlled impedance lines on all high-frequency inputs and outputs. Proper grounding of the GND pins is fundamental; if the PC board uses a topside RF ground, connect all GND pins directly to it. For boards where the ground plane is not on the component side, it's best to connect all GND pins to the ground plane with plated through-holes close to the package.

To minimize coupling between different sections of the system, the ideal power-supply layout is a star configuration with a large decoupling capacitor at a central VCC node. The VCC traces branch out from this central node, each leading to a separate VCC node on the PC board. A second bypass capacitor that has low ESR at the RF frequency of operation is placed at the end of each trace. This arrangement provides local decoupling at the VCC pin. At high frequencies, any signal leaking out of one supply pin sees a relatively high impedance (formed by the VCC trace inductance) to the central VCC node and an even higher impedance to any other supply pin, as well as a low impedance to ground through its bypass capacitor.

## Chip Information

MAX2651 TRANSISTOR COUNT: 272

MAX2652 TRANSISTOR COUNT: 272

MAX2653 TRANSISTOR COUNT: 253

MAX2651/MAX2652/MAX2653

# GSM900 and DCS1800/PCS1900 Dual-Band, Low-Noise Amplifiers

## Package Information

(The package drawing(s) in this data sheet may not reflect the most current specifications. For the latest package outline information, go to [www.maxim-ic.com/packages](http://www.maxim-ic.com/packages).)

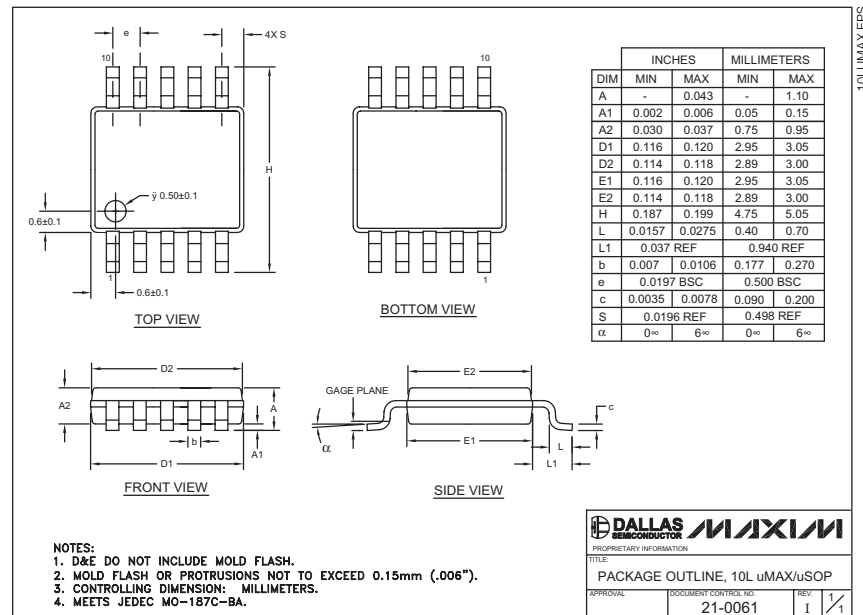
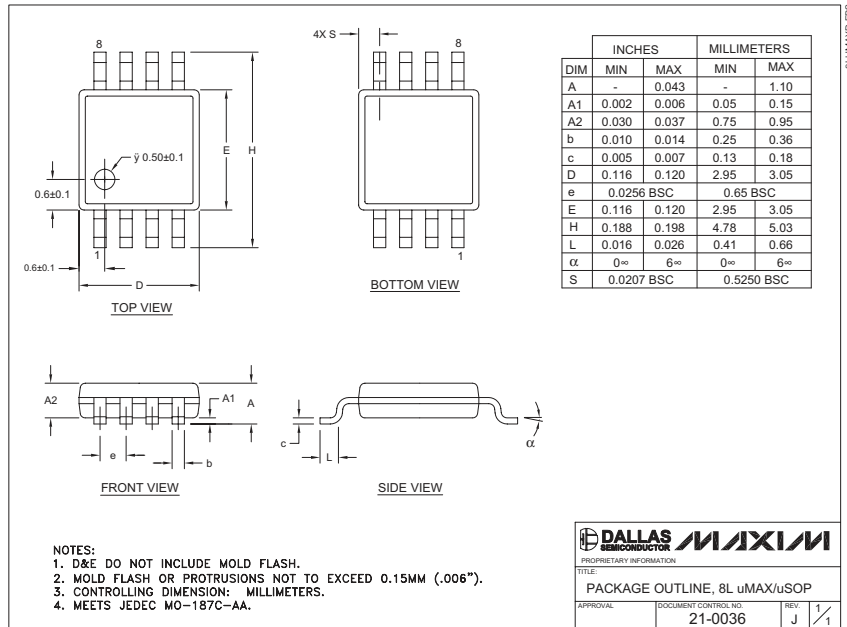

**Note:** The packages for these devices do not feature the exposed pad.

Maxim cannot assume responsibility for use of any circuitry other than circuitry entirely embodied in a Maxim product. No circuit patent licenses are implied. Maxim reserves the right to change the circuitry and specifications without notice at any time.

16 **Maxim Integrated Products, 120 San Gabriel Drive, Sunnyvale, CA 94086 408-737-7600**