

GlobTek, Inc. www.globtek.com 186 Veterans Drive, Northvale, NJ 07647 Tel. (201) 784-1000 Fax (201) 784-0111	Drawing Title: GT-96180-1848-T3-PP, PoE, Passive Power Injector, Efficiency Level: USA DOE Level VI / Eco-design Directive 2009/125/EC, (EU) 2019/1782, Case Color/Style: GlobTek Black, Desktop/External, Single Port Power Over Ethernet Midspan (IEEE802.3af PoE PSE), Input Rating: 100-240V~, 50-60 Hz, IEC 60320/C14 , Output Rating: 18W, 48.0V@0.375A, Output Configuration: N/A mm, N/A/ Cond, N/A, None, Ferrite: None, N/A, GT Cord # C0745, Pin Out: PoE injector wiring Data, Data+Power, RJ45 x 2, Blades/Input Cord: Not Applicable, Approvals: CB 62368; Patent US9838207B2; EAC; UKCA; ETL 62368; cETLus 62368-1; Morocco; S-Mark 62368; CE; China RoHS; Level VI; PSE; RoHS; Ukraine; VCCI; WEEE; Class I; ETL; S-Mark 60950; CB 60335; LPS 62368;	
	Model No. GT-96180-1848-T3-PP	
	Part No./Ordering No. GT-96180-1848-T3-PP	Rev D1

In Addition to GlobTek Inc.'s renewed ISO9001:2015 - Quality Management System Certification, GlobTek Inc. is now certified to:

ISO13485:2016 - Medical Devices Quality Management System Certification
ISO14001:2015 - Environmental Management System Certification

ISO Certificates are available online at <https://www.globtek.com/iso-certificates/>

The acceptance of this specification and use of the product described in this document indicates the acceptance and binding of the customer to Globtek TERMS AND CONDITIONS (attached to the end of this document), which supersede all other agreements, terms, and conditions (<https://en.globtek.com/terms-and-conditions/>).

The purchaser of this product (Customer) agrees that it is their sole responsibility to determine suitability/fitness of the product described in this specification for their application and to take precautions for protection against any hazards attendant to the handling and use of the product.

Footnote:

GlobTek Inc. will not be liable for the safety and performance of these power supplies/battery packs if unauthorized access and repair occurs. End user should consult applicable UL, CSA or EN standards for proper installation instruction.

Limitation of Use:

GlobTek products are intended for use with commercial, medical, and/or industrial equipment only. GlobTek product are not authorized for use as mission critical components in life support hazardous environment, nuclear or aircraft applications without prior written approval from the CEO of GlobTek Inc.

Contents of this document are subject to change without prior notice.

Customer Approval of Specification:

Please approve, sign and send back to GlobTek so we can complete order processing.
A delay in receipt of this form will delay delivery schedule.

Company Name: _____	Customer P/N: _____
Quote Number: _____	Date: _____
Authorized Representative Name: _____	Authorized Representative Signature: _____

GlobTek, Inc. www.globtek.com 186 Veterans Drive, Northvale, NJ 07647 Tel. (201) 784-1000 Fax (201) 784-0111	Drawing Title: GT-96180-1848-T3-PP, PoE, Passive Power Injector, Efficiency Level: USA DOE Level VI / Eco-design Directive 2009/125/EC, (EU) 2019/1782, Case Color/Style: GlobTek Black, Desktop/External, Single Port Power Over Ethernet Midspan (IEEE802.3af PoE PSE), Input Rating: 100-240V~, 50-60 Hz, IEC 60320/C14 , Output Rating: 18W, 48.0V@0.375A, Output Configuration: N/A mm, N/A/ Cond, N/A, None, Ferrite: None, N/A, GT Cord # C0745, Pin Out: PoE injector wiring Data, Data+Power, RJ45 x 2, Blades/Input Cord: Not Applicable, Approvals: CB 62368; Patent US9838207B2; EAC; UKCA; ETL 62368; cETLus 62368-1; Morocco; S-Mark 62368; CE; China RoHS; Level VI; PSE; RoHS; Ukraine; VCCI; WEEE; Class I; ETL; S-Mark 60950; CB 60335; LPS 62368;	
	Model No. GT-96180-1848-T3-PP	
	Part No./Ordering No. GT-96180-1848-T3-PP	Rev D1

REVISION HISTORY

REV	DESCRIPTION	SUB	DATE	APPROVED
D1	Update grounding configuration from E1 to F3	QA	07/17/2020	QA
D	Update pinout to POE RJ45X2, change packing: master carton dimensions to 442*330*275 mm, gidd box dimensions to 125*105*43 mm, Qty to 60pcs/carton	QA	07/25/2019	QA
C	Add EAC to approvals	QA	07/06/2018	QA
B	Update output current from 0.37A to 0.375A	QA	02/07/2018	QA
A	Initial Release	jwarn	05/02/2017	QA

POWER SUPPLY INFORMATION

TYPE	Desktop/External
TECHNOLOGY	Single Port Power Over Ethernet Midspan (IEEE802.3af PoE PSE)
CASE COLOR	GlobTek Black
NAMEPLATE RATED INPUT	100-240V~, 50-60 Hz, 0.6A
INPUT CONFIG	IEC 60320/C14
WATTS	18.00
VOLTS OUT	48.0
CURRENT OUT (Amps)	0.375
BLADE/CORD INCLUDED	N/A Not Applicable
BLADE/CORD INSTALLED	N/A :Not Applicable
INGRESS PROTECTION	
GROUNDING CONFIGURATION	(F3) Floating output/Isolated Common by Capacitor
EFFICIENCY LEVEL	USA DOE Level VI / Eco-design Directive 2009/125/EC, (EU) 2019/1782
OUTPUT CONFIGURATION	N/A mm, N/A/ Cond, N/A, None, Ferrite: None, N/A, GT Cord # C0745
CONNECTOR PIN OUT	PoE injector wiring Data, Data+Power, RJ45 x 2
LABEL SPECS	Standard GT,L-1186
SPECIAL BARCODE LABEL MATERIAL	No
PACK SPEC	Standard DT, Individually Box
USER MANUAL	

PROPRIETARY INFORMATION

PROPRIETARY OF GLOBTEK, INC. ANY REPRODUCTION, DISCLOSURE OR USE OF THIS DRAWING, IN WHOLE OR IN PART, IS HEREBY PROHIBITED EXCEPT AS SPECIFIED IN

WRITING BY GLOBTEK, INC. © GlobTek, Inc. 2017 - 2023

quest / 08/08/2023 12:00:02 AM GMT

GlobTek, Inc. www.globtek.com 186 Veterans Drive, Northvale, NJ 07647 Tel. (201) 784-1000 Fax (201) 784-0111	Drawing Title: GT-96180-1848-T3-PP, PoE, Passive Power Injector, Efficiency Level: USA DOE Level VI / Eco-design Directive 2009/125/EC, (EU) 2019/1782, Case Color/Style: GlobTek Black, Desktop/External, Single Port Power Over Ethernet Midspan (IEEE802.3af PoE PSE), Input Rating: 100-240V~, 50-60 Hz, IEC 60320/C14 , Output Rating: 18W, 48.0V@0.375A, Output Configuration: N/A mm, N/A/ Cond, N/A, None, Ferrite: None, N/A, GT Cord # C0745, Pin Out: PoE injector wiring Data, Data+Power, RJ45 x 2, Blades/Input Cord: Not Applicable, Approvals: CB 62368; Patent US9838207B2; EAC; UKCA; ETL 62368; cETLus 62368-1; Morocco; S-Mark 62368; CE; China RoHS; Level VI; PSE; RoHS; Ukraine; VCCI; WEEE; Class I; ETL; S-Mark 60950; CB 60335; LPS 62368;	
	Model No. GT-96180-1848-T3-PP	
	Part No./Ordering No. GT-96180-1848-T3-PP	Rev D1

Notes/Modifications/Customizations (notes in this section supersede the values shown in the standard spec)

DIMENSIONS ARE IN MM UNLESS SPECIFIED OTHERWISE

GloTek, Inc. www.globtek.com 186 Veterans Drive, Northvale, NJ 07647 Tel. (201) 784-1000 Fax (201) 784-0111	Drawing Title: GT-96180-1848-T3-PP, PoE, Passive Power Injector, Efficiency Level: USA DOE Level VI / Eco-design Directive 2009/125/EC, (EU) 2019/1782, Case Color/Style: GlobTek Black, Desktop/External, Single Port Power Over Ethernet Midspan (IEEE802.3af PoE PSE), Input Rating: 100-240V~, 50-60 Hz, IEC 60320/C14 , Output Rating: 18W, 48.0V@0.375A, Output Configuration: N/A mm, N/A/ Cond, N/A, None, Ferrite: None, N/A, GT Cord # C0745, Pin Out: PoE injector wiring Data, Data+Power, RJ45 x 2, Blades/Input Cord: Not Applicable, Approvals: CB 62368; Patent US9838207B2; EAC; UKCA; ETL 62368; cETLus 62368-1; Morocco; S-Mark 62368; CE; China RoHS; Level VI; PSE; RoHS; Ukraine; VCCI; WEEE; Class I; ETL; S-Mark 60950; CB 60335; LPS 62368;	
	Model No. GT-96180-1848-T3-PP	
	Part No./Ordering No. GT-96180-1848-T3-PP	Rev D1

ELECTRICAL SPECIFICATIONS

GloTek's 18W and 36W Passive Power over Ethernet Midspan Injectors offers cost effective and reliable solution for remote powering of specialized non-standard Ethernet Powered Devices requiring up to 36 Watts over existing network infrastructure. These Passive Injectors are configured to provide 18 or 36 watts of power over two pairs (4,5 + and 7,8 -) per IEEE 802.3 defined wires. When the load device is connected, GloTek's Passive PoE Injector will immediately source power to the Powered Device. GloTek's 56V Passive PoE Injectors are designed to function with and provide power to any IEEE 802.3af or 802.3at PoE device. For specialized applications GloTek can also provide lower output voltage models between 18V and 54V with reduced circuit complexity, these are referred to as our Simple Power over Ethernet Injector products.

MAIN FEATURES

- Cost Effective Passive PoE, supplies continuous power without requiring handshaking communications
- Output can source up to 18W or 36W at 18V, 24V, 36V, 48V, 54V or 56V
- Withstands high energy EMI Immunity events without going into latched shutdown state
- Short Circuit and Overload Protection protects Ethernet cabling if Splitter has a Short Circuit
- Green LED Indicates Output Power Availability
- Passive PoE models can transfer 10/100/1000 BaseT Data Rates (Gigabit compatible)
- Simple, Low Cost PoE models can transfer 10/100 BaseT Data Rates
- Universal Input Power from 100Vac to 240Vac
- Green Design: Compliant to DoE Efficiency level VI requirement
- Full Protection for Over Voltage and Current
- Compact 104 x 54 x 40 mm (w/o MTG Flange)

APPLICATIONS

- Custom Ethernet Power Distribution Architecture
- Network Security Cameras
- Point of Sales
- Industrial Controllers
- Electronic Time Card Readers
- Building Security Systems
- Network Camera with Pan, Tilt and Zoom Features
- Electronic Signs
- RFID Readers
- Motion Sensors
- HVAC Controllers
- Magnetic Card Readers
- Digital Time clock

A) ELECTRICAL SPECIFICATIONS:

INPUT

Input Range: 90-264 Vac (85-264Vac @ 85% of rated output power)

Input Line Frequency: 47-63Hz

PROPRIETARY INFORMATION

PROPRIETARY OF GLOBTEK, INC. ANY REPRODUCTION, DISCLOSURE OR USE OF THIS DRAWING, IN WHOLE OR IN PART, IS HEREBY PROHIBITED EXCEPT AS SPECIFIED IN

WRITING BY GLOBTEK, INC. © GloTek, Inc. 2017 - 2023

quest / 08/08/2023 12:00:02 AM GMT

GloTek, Inc. www.globtek.com 186 Veterans Drive, Northvale, NJ 07647 Tel. (201) 784-1000 Fax (201) 784-0111	Drawing Title: GT-96180-1848-T3-PP, PoE, Passive Power Injector, Efficiency Level: USA DOE Level VI / Eco-design Directive 2009/125/EC, (EU) 2019/1782, Case Color/Style: GlobTek Black, Desktop/External, Single Port Power Over Ethernet Midspan (IEEE802.3af PoE PSE), Input Rating: 100-240V~, 50-60 Hz, IEC 60320/C14, Output Rating: 18W, 48.0V@0.375A, Output Configuration: N/A mm, N/A Cond, N/A, None, Ferrite: None, N/A, GT Cord # C0745, Pin Out: PoE injector wiring Data, Data+Power, RJ45 x 2, Blades/Input Cord: Not Applicable, Approvals: CB 62368; Patent US9838207B2; EAC; UKCA; ETL 62368; cETLus 62368-1; Morocco; S-Mark 62368; CE; China RoHS; Level VI; PSE; RoHS; Ukraine; VCCI; WEEE; Class I; ETL; S-Mark 60950; CB 60335; LPS 62368;	
	Model No. GT-96180-1848-T3-PP	
	Part No./Ordering No. GT-96180-1848-T3-PP	Rev D1

Input Current: < 1A RMS @ 90Vac Full Load for 36W
< 0.6A RMS @ 90Vac Full Load for 18W
Inrush Current: 30/60A max at 115/230Vac
No load Power: < 100mW
Efficiency: > 87.4%, 4 Point Avg efficiency. Typical at Full Load for 36W
> 85.0%, 4 Point Avg efficiency. Typical at Full Load for 18W
Turn on-delay: 1 Second Typical @ 115Vac
Input Line Protection: MOV Transient protected.
Hold-up time: 8ms typical at nominal input voltage and full load
Touch current at output: <100uA
Earth Leakage current at input: <100uA
Isolation: Input to Output, 3000 VAC

OUTPUT

Power Injection Pins: 4&5 for V+ and 7&8 for Common
Port Voltage: 56V standard, 18V to 54V optional
Port Power: 18W or 36W Max
Port Voltage Regulation: +/-3%, and less than 57Vdc
Port Voltage Ripple: 100mVpp max

B) ENVIRONMENTAL

Temperature: Operating, -10C to 40C
Storage, -30C to 80C
Humidity: 0% to 95% Relative Humidity, Non-Condensing
Altitude: Operating, Up to 5000M

C) MECHANICALS / ENCLOSURE

Housing: High impact plastic, 94V0 polycarbonate, non-vented
Markings: Label and/or Pad Printed and/or Molded in the case
Dimensions: 104*54*40 mm (w/o MTG Flange)
Weight: 0.35 Lb, 155 gr.
AC Input mechanical options: Desktop C6, C8, C14 or C18 IEC Inlet.
Hybrid option (Desktop or Changeable Blade Wall Plug-in) Class I or Class II input
Data and Data+Power Connector: Fully Shielded RJ45

D) EMISSIONS and IMMUNITY

Emission: Meets FCC Class B Part 15, EN55022 Class B
Immunity: Meets the following;
EN610000-6-2 (Industrial Level Immunity Compliance, extended levels shown in parenthesis)
EN 61000-4-2 ESD (+/-18KV Air, +/-8KV Contact, criteria A) (+/-20KV Air, +/-10KV Contact, criteria B)
EN 61000-4-3 Radiated Immunity
EN 61000-4-4 EFT (+/-2.5KV, criteria A) (+/-4KV, criteria B)

PROPRIETARY INFORMATION

PROPRIETARY OF GLOBTEK, INC. ANY REPRODUCTION, DISCLOSURE OR USE OF THIS DRAWING, IN WHOLE OR IN PART, IS HEREBY PROHIBITED EXCEPT AS SPECIFIED IN

WRITING BY GLOBTEK, INC. © GlobTek, Inc. 2017 - 2023

quest / 08/08/2023 12:00:02 AM GMT

GloBtek, Inc. www.globtek.com 186 Veterans Drive, Northvale, NJ 07647 Tel. (201) 784-1000 Fax (201) 784-0111	Drawing Title: GT-96180-1848-T3-PP, PoE, Passive Power Injector, Efficiency Level: USA DOE Level VI / Eco-design Directive 2009/125/EC, (EU) 2019/1782, Case Color/Style: GloBtek Black, Desktop/External, Single Port Power Over Ethernet Midspan (IEEE802.3af PoE PSE), Input Rating: 100-240V~, 50-60 Hz, IEC 60320/C14, Output Rating: 18W, 48.0V@0.375A, Output Configuration: N/A mm, N/A Cond, N/A, None, Ferrite: None, N/A, GT Cord # C0745, Pin Out: PoE injector wiring Data, Data+Power, RJ45 x 2, Blades/Input Cord: Not Applicable, Approvals: CB 62368; Patent US9838207B2; EAC; UKCA; ETL 62368; cETLus 62368-1; Morocco; S-Mark 62368; CE; China RoHS; Level VI; PSE; RoHS; Ukraine; VCCI; WEEE; Class I; ETL; S-Mark 60950; CB 60335; LPS 62368;	
	Model No. GT-96180-1848-T3-PP	
	Part No./Ordering No. GT-96180-1848-T3-PP	Rev D1

EN 61000-4-5 Surge (+/-2KV Line-Line, +/-4KV Line to Gnd, criteria A)
EN 61000-4-6 Conducted Susceptibility
EN 61000-4-11 Voltage Dips and Interrupts
EN 61000-3-2 Harmonics, Class A

E) SAFETY APPROVALS

Compliant Safety Standards: See listings at end of this drawing for specifics

F) INTEROPERABILITY: Passive and Simple 48V and 56V models work with all types of AF and AT Splitters and PoE appliances with appropriate input power requirements

G) SPECIAL OPTIONS

1. Custom Markings
2. High Rel PCB laminate with Plated through Holes for IPC610 Class 2 Compliance
3. Special Housing Color
4. Reduced Output Voltage, 18V to 54V

18W PoE Injector, Ethernet InterOperability and Compatibility Testing

Injector tested: *Model GT-96180-1856*, rated 18W output, 56Vdc, IEEE802.3-2003 af Compliant

Note, assuming 80% eff splitter, max Pout = 14.4W (14.4/18 = 0.8)

Splitter Model Used	Splitter Description	Splitter O/P Power Rating	Splitter Load During Testing
GloBtek GT-91087	5V, af type	8W	7.5W
PowerDSine PD-AS-601/5	5V, af type	10W	
Linksys POEES5	5V, af type	10W	
Axis 5008-001-02	5V, af type	10W	14W
PowerDSine PD-AS-701/12	12V, at type	24W	
Phihong POE21-120-R	12V, at type	21W	
Cisco 7970 Series Phone	IP Phone, af type	Input to Phone rating 48V, 0.38A	

100BaseT/1000 Base T network digital transmission testing

(During testing ethernet communications is passed thru Injector and then Splitter and then to a computer)

Injector tested: *Model GT-96180-1856*, rated 18W output, 56Vdc, IEEE802.3-2003 af Compliant

Injector is Gigabit designed and tested, to 100 Base T and 1000 Base T

Splitter Model Used	Splitter Description	P/F	Notes:
Axis 5008-001-02	100 Base T rating	P	Limited bandwidth splitter
PowerDSine PD-AS-701/12	1000 Base T rating	P	Full bandwidth splitter

GlobTek, Inc. www.globtek.com 186 Veterans Drive, Northvale, NJ 07647 Tel. (201) 784-1000 Fax (201) 784-0111	Drawing Title: GT-96180-1848-T3-PP, PoE, Passive Power Injector, Efficiency Level: USA DOE Level VI / Eco-design Directive 2009/125/EC, (EU) 2019/1782, Case Color/Style: GlobTek Black, Desktop/External, Single Port Power Over Ethernet Midspan (IEEE802.3af PoE PSE), Input Rating: 100-240V~, 50-60 Hz, IEC 60320/C14 , Output Rating: 18W, 48.0V@0.375A, Output Configuration: N/A mm, N/A/ Cond, N/A, None, Ferrite: None, N/A, GT Cord # C0745, Pin Out: PoE injector wiring Data, Data+Power, RJ45 x 2, Blades/Input Cord: Not Applicable, Approvals: CB 62368; Patent US9838207B2; EAC; UKCA; ETL 62368; cETLus 62368-1; Morocco; S-Mark 62368; CE; China RoHS; Level VI; PSE; RoHS; Ukraine; VCCI; WEEE; Class I; ETL; S-Mark 60950; CB 60335; LPS 62368;	
	Model No. GT-96180-1848-T3-PP	
	Part No./Ordering No. GT-96180-1848-T3-PP	Rev D1

TO ADDRESS SYSTEM-LEVEL EMI CONCERNS, FERRITE CHOKES/BEADS MAY BE ADDED/REVISED UPON REQUEST. A SAMPLE KIT OF GLOBTEK'S STANDARD FERRITES IS AVAILABLE UNDER GLOBTEK P/N: EMI-MITIGATION-KIT1

FOR ADDITIONAL INFORMATION, PLEASE READ OUR WHITE PAPER AT: <https://r.globtek.info/3QeaqtD>

<p>GlobTek, Inc. www.globtek.com 186 Veterans Drive, Northvale, NJ 07647 Tel. (201) 784-1000 Fax (201) 784-0111</p>	<p>Drawing Title: GT-96180-1848-T3-PP, PoE, Passive Power Injector, Efficiency Level: USA DOE Level VI / Eco-design Directive 2009/125/EC, (EU) 2019/1782, Case Color/Style: GlobTek Black, Desktop/External, Single Port Power Over Ethernet Midspan (IEEE802.3af PoE PSE), Input Rating: 100-240V~, 50-60 Hz, IEC 60320/C14 , Output Rating: 18W, 48.0V@0.375A, Output Configuration: N/A mm, N/A/ Cond, N/A, None, Ferrite: None, N/A, GT Cord # C0745, Pin Out: PoE injector wiring Data, Data+Power, RJ45 x 2, Blades/Input Cord: Not Applicable, Approvals: CB 62368; Patent US9838207B2; EAC; UKCA; ETL 62368; cETLus 62368-1; Morocco; S-Mark 62368; CE; China RoHS; Level VI; PSE; RoHS; Ukraine; VCCI; WEEE; Class I; ETL; S-Mark 60950; CB 60335; LPS 62368;</p>
	<p>Model No. GT-96180-1848-T3-PP</p>
	<p>Part No./Ordering No. GT-96180-1848-T3-PP</p>
	<p>Rev D1</p>

3D File Download <https://www.globtek.com/dl/GT-96180-WVVV-T3-PP.stp>

Mechanical drawing

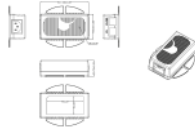

GlobTek, Inc.
 www.globtek.com
 186 Veterans Drive,
 Northvale, NJ 07647
 Tel. (201) 784-1000
 Fax (201) 784-0111

Drawing Title: GT-96180-1848-T3-PP, PoE, Passive Power Injector, Efficiency Level: USA DOE Level VI / Eco-design Directive 2009/125/EC, (EU) 2019/1782, Case Color/Style: GlobTek Black, Desktop/External, Single Port Power Over Ethernet Midspan (IEEE802.3af PoE PSE), Input Rating: 100-240V~, 50-60 Hz, IEC 60320/C14, Output Rating: 18W, 48.0V@0.375A, Output Configuration: N/A mm, N/A Cond, N/A, None, Ferrite: None, N/A, GT Cord # C0745, Pin Out: PoE injector wiring Data, Data+Power, RJ45 x 2, Blades/Input Cord: Not Applicable, Approvals: CB 62368; Patent US9838207B2; EAC; UKCA; ETL 62368; cETLus 62368-1; Morocco; S-Mark 62368; CE; China RoHS; Level VI; PSE; RoHS; Ukraine; VCCI; WEEE; Class I; ETL; S-Mark 60950; CB 60335; LPS 62368;

Model No. GT-96180-1848-T3-PP

Part No./Ordering No. GT-96180-1848-T3-PP

Rev D1

DERATING CURVE

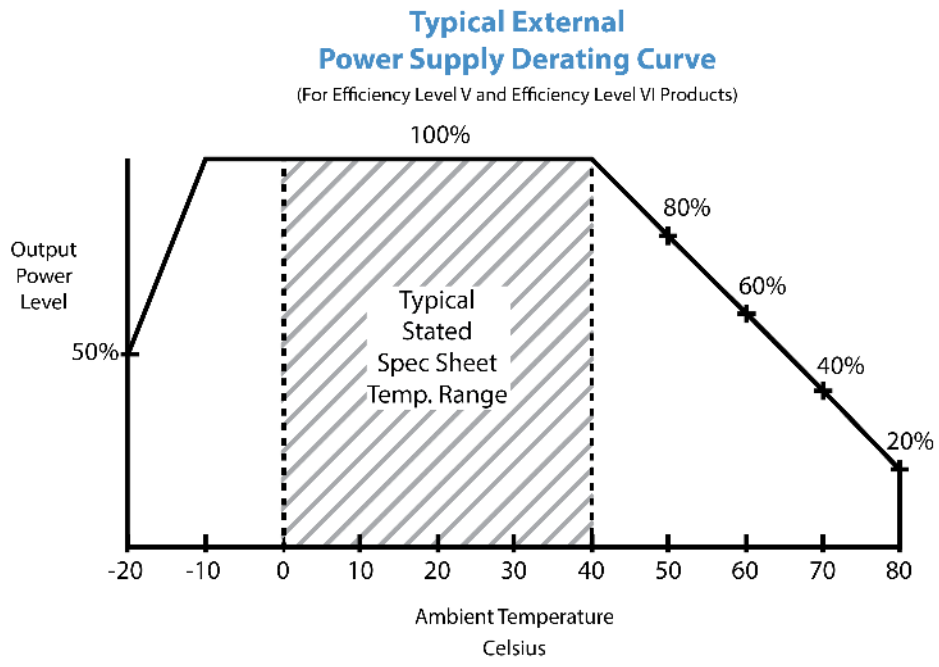

GlobTek, Inc.
 www.globtek.com
 186 Veterans Drive,
 Northvale, NJ 07647
 Tel. (201) 784-1000
 Fax (201) 784-0111

Drawing Title: GT-96180-1848-T3-PP, PoE, Passive Power Injector, Efficiency Level: USA DOE Level VI / Eco-design Directive 2009/125/EC, (EU) 2019/1782, Case Color/Style: GlobTek Black, Desktop/External, Single Port Power Over Ethernet Midspan (IEEE802.3af PoE PSE), Input Rating: 100-240V~, 50-60 Hz, IEC 60320/C14 , Output Rating: 18W, 48.0V@0.375A, Output Configuration: N/A mm, N/A/ Cond, N/A, None, Ferrite: None, N/A, GT Cord # C0745, Pin Out: PoE injector wiring Data, Data+Power, RJ45 x 2, Blades/Input Cord: Not Applicable, Approvals: CB 62368; Patent US9838207B2; EAC; UKCA; ETL 62368; cETLus 62368-1; Morocco; S-Mark 62368; CE; China RoHS; Level VI; PSE; RoHS; Ukraine; VCCI; WEEE; Class I; ETL; S-Mark 60950; CB 60335; LPS 62368;

Model No. GT-96180-1848-T3-PP

Part No./Ordering No. GT-96180-1848-T3-PP

Rev D1

INPUT CONFIGURATION

(F3) Floating output/Isolated Common by Capacitor

GTM21089, GTM21097 and
 GTM961600 Optional Config

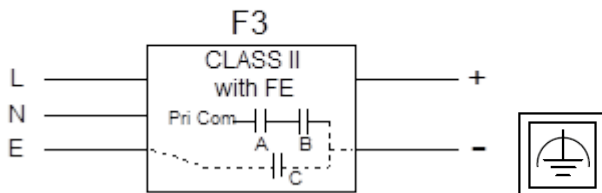

[Alternate grounding configurations](#) available upon request.

Blades/Cord Included:N/A:Not Applicable

Blades/Cord Installed:N/A:Not Applicable

IEC 60320/C14 AC Inlet Connector, Class I, Earth Ground

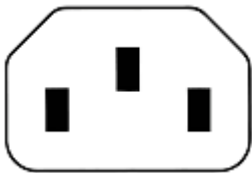

Mates with IEC 60320/C13 Plug

Optional Locking IEC60320 Receptacle and cord option available on some models by request.:



[Standard International IEC 320/C13 Cordsets](#)

Below are standard cordsets which are "not included" (unless stated above); these can be purchased separately or packaged with the power supply. Contact your Sales Engineer if the style required is not shown below. Many more available in different lengths, colors or cable material.

GlobTek, Inc. www.globtek.com 186 Veterans Drive, Northvale, NJ 07647 Tel. (201) 784-1000 Fax (201) 784-0111	Drawing Title: GT-96180-1848-T3-PP, PoE, Passive Power Injector, Efficiency Level: USA DOE Level VI / Eco-design Directive 2009/125/EC, (EU) 2019/1782, Case Color/Style: GlobTek Black, Desktop/External, Single Port Power Over Ethernet Midspan (IEEE802.3af PoE PSE), Input Rating: 100-240V~, 50-60 Hz, IEC 60320/C14, Output Rating: 18W, 48.0V@0.375A, Output Configuration: N/A mm, N/A Cond, N/A, None, Ferrite: None, N/A, GT Cord # C0745, Pin Out: PoE injector wiring Data, Data+Power, RJ45 x 2, Blades/Input Cord: Not Applicable, Approvals: CB 62368; Patent US9838207B2; EAC; UKCA; ETL 62368; cETLus 62368-1; Morocco; S-Mark 62368; CE; China RoHS; Level VI; PSE; RoHS; Ukraine; VCCI; WEEE; Class I; ETL; S-Mark 60950; CB 60335; LPS 62368;	
	Model No. GT-96180-1848-T3-PP	
	Part No./Ordering No. GT-96180-1848-T3-PP	Rev D1

Stock Power Supply Cords

Part Number/ Link	Country	Plug	Termination	Length (mm)	(Ft)
3021457F701(R)	N. American (Type B)	NEMA 5-15P	IEC 320/C13	2150	7
1191068F0701(R)	N. American (Type B)	NEMA 5-15P Hospital	IEC 320/C13	2459	8
2194272M5701-T(R)	Argentina (Type I)	IRAM 2073	IEC 320/C13	2500	8
5502022M5701A(R)	Australian (Type I)	AS3112 / 3 PRONG	IEC 320/C13	2500	8
204B4272M5701(R)	Brazil (Type N)	BRAZIL	IEC 320/C13	2500	8
6023602M5701(R)	China (Type I)	CCC GR2099	IEC 320/C13	2500	8
G8014272M5701(R)	Danish (Type K)	AFSNIT SECTION 107-2-D1	IEC 320/C13	2500	8
23144272M5701-T(R)	Europe (Type E)	CEE 7/7	IEC 320/C13	2500	8
23134272M5701EUKR(R)	Europe/Korea Combo (Type E)	CEE 7/7 / KSC8305	IEC 320/C13	2500	8
205IN4272M5701(R)	India (Type D)	India IS 1293 (also known as IA16A3 or BS546)	IEC 320/C13	2500	8
208IN4272M5701(R)	India (Type M)	India IS 1293 (also known as IA16A3 or BS546)	IEC320/C13	2500	8
377C4272M5701(R)	Israel (Type H)	ISL 377C	IEC 320/C13	2500	8
23024272M5701(R)	Italy (Type L)	CEI 23-16/VII	IEC 320/C13	2500	8
3003339F701(R) [3x1.25mm2]	Japan (Type B)	JIS 8303 / 3 PINS	IEC 320/C13	2500	8
3003068F2701-HK(R) [3 x 2.0mm2]					
302J115J6F0701J(R)	North America / Japan (Type B – 12A)	NEMA 5-15P (cULus approved), Japan JIS C 8303 (PSE Approved)	IEC 320/C13	1830	6
302J104J6F0701J(R)	North America / Japan (Type B – 15A)	NEMA 5-15P (cULus approved), Japan JIS C 8303 (PSE Approved)	IEC 320/C13	1830	6
302JT104J9F0701JT(R)	North America / Japan / Taiwan (Type B – 15A)	NEMA 5-15P (cULus approved), Japan JIS C 8303 (PSE Approved), Taiwan CNS 6797 (BSMI Approved)	IEC 320/C13	2800	9
2313K3432M5701(R)	Korea (Type F)	KS C 8305	IEC 320/C13	2500	8
5804272M5701(R)	Russia (Type F)	GOST 7396	IEC 320/C13	2500	8
2084272M5701(R)	South Africa (Type M)	South Africa SABS164-1 (16A type)	IEC 320/C13	2500	8

PROPRIETARY INFORMATION

PROPRIETARY OF GLOBTEK, INC. ANY REPRODUCTION, DISCLOSURE OR USE OF THIS DRAWING, IN WHOLE OR IN PART, IS HEREBY PROHIBITED EXCEPT AS SPECIFIED IN Page 11 of 19

WRITING BY GLOBTEK, INC. © GlobTek, Inc. 2017 - 2023

quest / 08/08/2023 12:00:02 AM GMT

GloBtek, Inc. www.globtek.com 186 Veterans Drive, Northvale, NJ 07647 Tel. (201) 784-1000 Fax (201) 784-0111	Drawing Title: GT-96180-1848-T3-PP, PoE, Passive Power Injector, Efficiency Level: USA DOE Level VI / Eco-design Directive 2009/125/EC, (EU) 2019/1782, Case Color/Style: GloBtek Black, Desktop/External, Single Port Power Over Ethernet Midspan (IEEE802.3af PoE PSE), Input Rating: 100-240V~, 50-60 Hz, IEC 60320/C14 , Output Rating: 18W, 48.0V@0.375A, Output Configuration: N/A mm, N/A/ Cond, N/A, None, Ferrite: None, N/A, GT Cord # C0745, Pin Out: PoE injector wiring Data, Data+Power, RJ45 x 2, Blades/Input Cord: Not Applicable, Approvals: CB 62368; Patent US9838207B2; EAC; UKCA; ETL 62368; cETLus 62368-1; Morocco; S-Mark 62368; CE; China RoHS; Level VI; PSE; RoHS; Ukraine; VCCI; WEEE; Class I; ETL; S-Mark 60950; CB 60335; LPS 62368;	
	Model No. GT-96180-1848-T3-PP	
	Part No./Ordering No. GT-96180-1848-T3-PP	Rev D1

23214272M5701(R)	Switzerland (Type J)	SEV 1011	IEC 320/C13	2500	8
3003322M5701(R)	Taiwan (Type B)	BSMI	IEC 320/C13	2500	8
6363762M5701(R)	Thailand (Type O)	TIS 166-2549	IEC 320/C13	2500	8
PZ0800100-2M5BK13H(R)	UK, Hong Kong, Singapore, Gulf States (Type G)	BS 1363A	IEC 320/C13	2500	8
7055002M5701A(R)	International	IEC 320 C14-C13	IEC 320/C13	2500	8

<p>GlobTek, Inc. www.globtek.com 186 Veterans Drive, Northvale, NJ 07647 Tel. (201) 784-1000 Fax (201) 784-0111</p>	<p>Drawing Title: GT-96180-1848-T3-PP, PoE, Passive Power Injector, Efficiency Level: USA DOE Level VI / Eco-design Directive 2009/125/EC, (EU) 2019/1782, Case Color/Style: GlobTek Black, Desktop/External, Single Port Power Over Ethernet Midspan (IEEE802.3af PoE PSE), Input Rating: 100-240V~, 50-60 Hz, IEC 60320/C14 , Output Rating: 18W, 48.0V@0.375A, Output Configuration: N/A mm, N/A/ Cond, N/A, None, Ferrite: None, N/A, GT Cord # C0745, Pin Out: PoE injector wiring Data, Data+Power, RJ45 x 2, Blades/Input Cord: Not Applicable, Approvals: CB 62368; Patent US9838207B2; EAC; UKCA; ETL 62368; cETLus 62368-1; Morocco; S-Mark 62368; CE; China RoHS; Level VI; PSE; RoHS; Ukraine; VCCI; WEEE; Class I; ETL; S-Mark 60950; CB 60335; LPS 62368;</p>
	<p>Model No. GT-96180-1848-T3-PP</p>
	<p>Part No./Ordering No. GT-96180-1848-T3-PP</p>
	<p>Rev D1</p>

OUTPUT CONNECTOR HOOK UP

TO ADDRESS SYSTEM-LEVEL EMI CONCERNS, FERRITE CHOKES/BEADS MAY BE ADDED/REVISED UPON REQUEST. A SAMPLE KIT OF GLOBTEK'S STANDARD FERRITES IS AVAILABLE UNDER GLOBTEK P/N: EMI-MITIGATION-KIT1

FOR ADDITIONAL INFORMATION, PLEASE READ OUR WHITE PAPER AT:

<https://en.globtek.com/technical-articles/ferrite-kit-radiated-emi-suppression-kit-for-globtek-power-supplies-cable-assemblies>

GloTek, Inc. www.globtek.com 186 Veterans Drive, Northvale, NJ 07647 Tel. (201) 784-1000 Fax (201) 784-0111	Drawing Title: GT-96180-1848-T3-PP, PoE, Passive Power Injector, Efficiency Level: USA DOE Level VI / Eco-design Directive 2009/125/EC, (EU) 2019/1782, Case Color/Style: GlobTek Black, Desktop/External, Single Port Power Over Ethernet Midspan (IEEE802.3af PoE PSE), Input Rating: 100-240V~, 50-60 Hz, IEC 60320/C14, Output Rating: 18W, 48.0V@0.375A, Output Configuration: N/A mm, N/A/ Cond, N/A, None, Ferrite: None, N/A, GT Cord # C0745, Pin Out: PoE injector wiring Data, Data+Power, RJ45 x 2, Blades/Input Cord: Not Applicable, Approvals: CB 62368; Patent US9838207B2; EAC; UKCA; ETL 62368; cETLus 62368-1; Morocco; S-Mark 62368; CE; China RoHS; Level VI; PSE; RoHS; Ukraine; VCCI; WEEE; Class I; ETL; S-Mark 60950; CB 60335; LPS 62368;	
	Model No. GT-96180-1848-T3-PP	
	Part No./Ordering No. GT-96180-1848-T3-PP	Rev D1

LABEL:L-1186

LABEL P/N	Standard GT
MATERIAL	Flat Thermal Transfer, Imprintable, Polyester Label and/or Pad Printed and/or Molded, and/or Laser Engraved in the case
BACKGROUND COLOR	Black if housing is Black, White or Silver if housing is White or Gray.
TEXT COLOR	White or Silver if label is Black Background for Black housing. Black if label is White or Silver background and Housing is White or Gray.
LABEL WIDTH (mm)	40
LABEL HEIGHT (mm)	80
SPECIAL BARCODE LABEL MATERIAL	No

Below is the minimum information which will appear on the label. NOTE: in the logo area additional/actual positioning of symbols and text is subjected to change as per agency updates/requirements or additional model approvals become available.
Regulatory certifications/label markings may be in logo area on the label or molded into the case housing outside the label area.
Information will be shown via label and/or pad printed and/or molded and/or laser engraved in the case. * Date code markings at GlobTek option

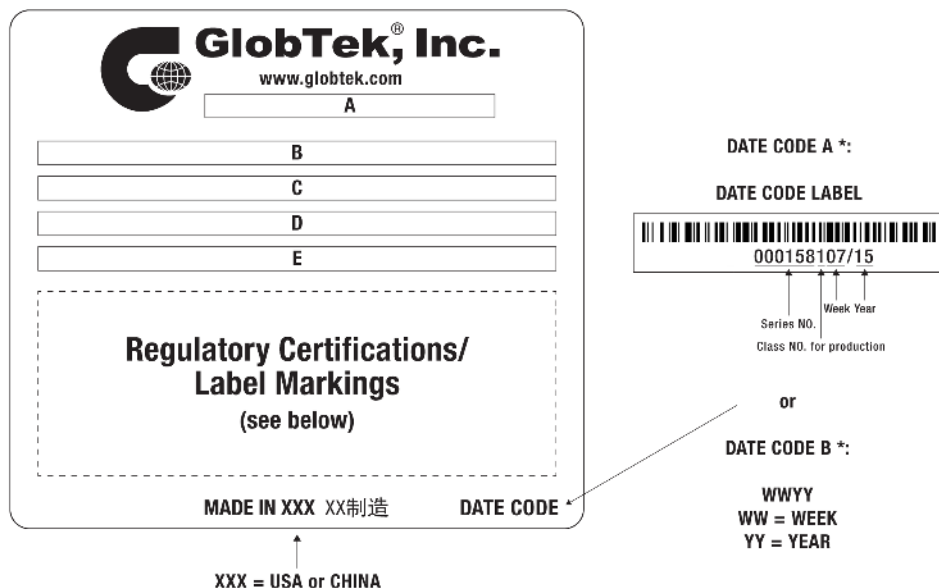

A=PoE, Passive Power Injector
B=P/N: (料号) GT-96180-1848-T3-PP
C=Model (型号) GT-96180-1848-T3-PP
D=Input (输入)100-240V~, 50-60 Hz, 0.6A
E=Output (输出)48.0 V 0.375 A, 18.00W

GlobTek, Inc. www.globtek.com 186 Veterans Drive, Northvale, NJ 07647 Tel. (201) 784-1000 Fax (201) 784-0111	Drawing Title: GT-96180-1848-T3-PP, PoE, Passive Power Injector, Efficiency Level: USA DOE Level VI / Eco-design Directive 2009/125/EC, (EU) 2019/1782, Case Color/Style: GlobTek Black, Desktop/External, Single Port Power Over Ethernet Midspan (IEEE802.3af PoE PSE), Input Rating: 100-240V~, 50-60 Hz, IEC 60320/C14 , Output Rating: 18W, 48.0V@0.375A, Output Configuration: N/A mm, N/A/ Cond, N/A, None, Ferrite: None, N/A, GT Cord # C0745, Pin Out: PoE injector wiring Data, Data+Power, RJ45 x 2, Blades/Input Cord: Not Applicable, Approvals: CB 62368; Patent US9838207B2; EAC; UKCA; ETL 62368; cETLus 62368-1; Morocco; S-Mark 62368; CE; China RoHS; Level VI; PSE; RoHS; Ukraine; VCCI; WEEE; Class I; ETL; S-Mark 60950; CB 60335; LPS 62368;	
	Model No. GT-96180-1848-T3-PP	
	Part No./Ordering No. GT-96180-1848-T3-PP	Rev D1

AGENCY ONLINE DOCUMENTS	http://www.globtek.info/certs/GT-96180-POE/
CE EC-Declaration for Medical	Contact GlobTek for more information
CE EC-Declaration for Industrial/Commercial/ITE	http://globtek.force.com/models/ec_declaration_product?id=01ta0000007dRJx&i=2
CE EC-Declaration for Household	Contact GlobTek for more information
UKCA-Declaration for Medical	Contact GlobTek for more information
UKCA-Declaration for Industrial/Commercial/ITE	http://globtek.force.com/models/ukca_declaration_product?id=01ta0000007dRJx&i=2
UKCA-Declaration for Household	Contact GlobTek for more information
Morocco SDoC Declaration	https://globtek.secure.force.com/models/Morocco_SDoC_Declaration?id=a0Oa0000000JPEFEA5
RoHS/RoHS3 Declaration	https://www.globtek.com/pdf/rohs_cert/01ta0000007dRJxAAM
REACH Declaration	https://www.globtek.com/pdf/iso_certificates/REACH.pdf
Conflict Minerals Declaration	https://www.globtek.com/pdf/conflict-minerals.pdf
Prop 65 Statement	https://en.globtek.com/prop-65-statement.pdf
IPXY rating is based on 3rd party testing and customers should check suitability and test system level IPXY rating before ordering.	

Regulatory Certifications/Label Markings

Below follows a link to the latest regulatory certifications and marks for this specific product. National standards as well as certification schemes are constantly changing and so is the set of certification marks and symbols applicable to this product. Various standards, marks and symbols, and certificates are subject to change at any time without notice.

Additional standards or unique country certifications are available upon request. Please contact Globtek to request a quotation.

LATEST PRODUCT/MODEL CERTIFICATIONS: <https://www.globtek.com/datasheet/w71144>

AGENCY ONLINE DOCUMENTS <http://www.globtek.info/certs/GT-96180-POE/>



(F3) Floating output/Isolated Common by Capacitor

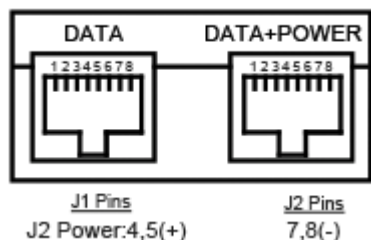

PoE injector wiring Data, Data+Power, RJ45 x 2

GlobTek, Inc. www.globtek.com 186 Veterans Drive, Northvale, NJ 07647 Tel. (201) 784-1000 Fax (201) 784-0111	Drawing Title: GT-96180-1848-T3-PP, PoE, Passive Power Injector, Efficiency Level: USA DOE Level VI / Eco-design Directive 2009/125/EC, (EU) 2019/1782, Case Color/Style: GlobTek Black, Desktop/External, Single Port Power Over Ethernet Midspan (IEEE802.3af PoE PSE), Input Rating: 100-240V~, 50-60 Hz, IEC 60320/C14 , Output Rating: 18W, 48.0V@0.375A, Output Configuration: N/A mm, N/A/ Cond, N/A, None, Ferrite: None, N/A, GT Cord # C0745, Pin Out: PoE injector wiring Data, Data+Power, RJ45 x 2, Blades/Input Cord: Not Applicable, Approvals: CB 62368; Patent US9838207B2; EAC; UKCA; ETL 62368; cETLus 62368-1; Morocco; S-Mark 62368; CE; China RoHS; Level VI; PSE; RoHS; Ukraine; VCCI; WEEE; Class I; ETL; S-Mark 60950; CB 60335; LPS 62368;	
	Model No. GT-96180-1848-T3-PP	
	Part No./Ordering No. GT-96180-1848-T3-PP	Rev D1

PACKAGING

Packing Spec P/N	Standard DT, Individually Box
Box Qty	60
Gift Box Size (mm)	125*105*43
Gift Box Color	White
Master Carton Size (mm)	442 x 330 x 275
Master Carton Cubic Volume (m³)	0.04
Master GW (Kg)	10.8 kg
BLADES INCLUDED	N/A: Not Applicable
BLADE/CORD INSTALLED	N/A: Not Applicable
USER MANUAL*	
USER MANUAL WEB LINK	

* This specification sheet is considered the user manual for all applications. It is expected that the buyer of this product will use it to formulate their own user manual for their end product and a user manual specifically for the power adapter is not usually required. If a user manual is not specifically listed above then none will be provided with this unit.

If specific packaging is required, this section must specify all requirements and note "no exceptions". If this section does not specify packaging, it is subject to change without notice at GlobTek's discretion

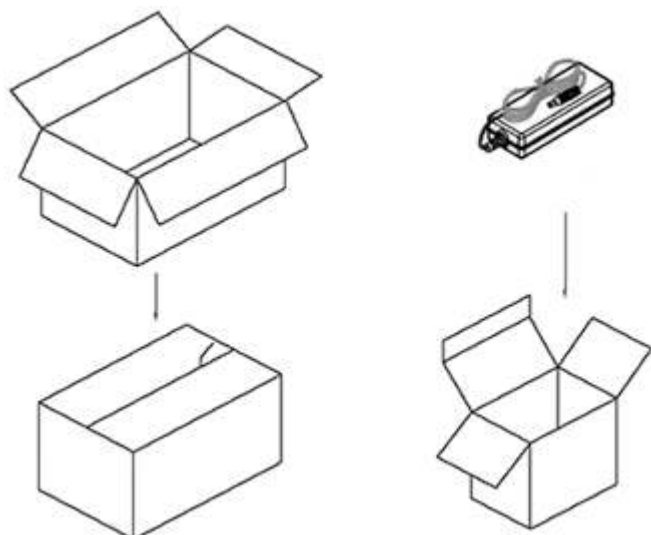

PROPRIETARY INFORMATION

GlobTek, Inc. www.globtek.com 186 Veterans Drive, Northvale, NJ 07647 Tel. (201) 784-1000 Fax (201) 784-0111	Drawing Title: GT-96180-1848-T3-PP, PoE, Passive Power Injector, Efficiency Level: USA DOE Level VI / Eco-design Directive 2009/125/EC, (EU) 2019/1782, Case Color/Style: GlobTek Black, Desktop/External, Single Port Power Over Ethernet Midspan (IEEE802.3af PoE PSE), Input Rating: 100-240V~, 50-60 Hz, IEC 60320/C14 , Output Rating: 18W, 48.0V@0.375A, Output Configuration: N/A mm, N/A Cond, N/A, None, Ferrite: None, N/A, GT Cord # C0745, Pin Out: PoE injector wiring Data, Data+Power, RJ45 x 2, Blades/Input Cord: Not Applicable, Approvals: CB 62368; Patent US9838207B2; EAC; UKCA; ETL 62368; cETLus 62368-1; Morocco; S-Mark 62368; CE; China RoHS; Level VI; PSE; RoHS; Ukraine; VCCI; WEEE; Class I; ETL; S-Mark 60950; CB 60335; LPS 62368;	
	Model No. GT-96180-1848-T3-PP	
	Part No./Ordering No. GT-96180-1848-T3-PP	Rev D1

INSTRUCTIONS TO THE OEM SYSTEMS ENGINEER

It is the responsibility of the OEM systems engineer to provide the end system user instructions and warnings for the use of this product in the end system.

If an input cord is required for this product, AC Mains voltage should be provided to the power supply by a power supply cord approved to the national standards of the country in which it will be used.

This product is not designed to be repaired. No serviceable parts inside. A blown internal fuse is an indication of catastrophic failure of circuit component(s). If a Failure Analysis is required for a failed power supply/battery charger, please return the damaged unit to GlobTek for an accurate determination of the root cause of the failure.

EMC Compliance of the complete OEM product, including the GlobTek power supply/battery charger needs to be verified by the OEM systems engineer.

INSTRUCTION SHEET

N/A

<p>GlobTek, Inc. www.globtek.com 186 Veterans Drive, Northvale, NJ 07647 Tel. (201) 784-1000 Fax (201) 784-0111</p>	<p>Drawing Title: GT-96180-1848-T3-PP, PoE, Passive Power Injector, Efficiency Level: USA DOE Level VI / Eco-design Directive 2009/125/EC, (EU) 2019/1782, Case Color/Style: GlobTek Black, Desktop/External, Single Port Power Over Ethernet Midspan (IEEE802.3af PoE PSE), Input Rating: 100-240V~, 50-60 Hz, IEC 60320/C14 , Output Rating: 18W, 48.0V@0.375A, Output Configuration: N/A mm, N/A/ Cond, N/A, None, Ferrite: None, N/A, GT Cord # C0745, Pin Out: PoE injector wiring Data, Data+Power, RJ45 x 2, Blades/Input Cord: Not Applicable, Approvals: CB 62368; Patent US9838207B2; EAC; UKCA; ETL 62368; cETLus 62368-1; Morocco; S-Mark 62368; CE; China RoHS; Level VI; PSE; RoHS; Ukraine; VCCI; WEEE; Class I; ETL; S-Mark 60950; CB 60335; LPS 62368;</p>
	<p>Model No. GT-96180-1848-T3-PP</p>
	<p>Part No./Ordering No. GT-96180-1848-T3-PP</p>
	<p>Rev D1</p>

