



Computing & Communications SBU - AC-DC APPLICATIONS GROUP

222 Kansas Street, EL Segundo 90245 CALIFORNIA, USA

# **IRAC1150-300W Demo Board User's Guide**

**Rev 3.0**

8/2/2005

## Table of Contents

1	INTRODUCTION.....	3
1.1	Features .....	3
2	DESCRIPTION.....	4
2.1	Demo Board Specifications .....	4
2.2	Schematic.....	5
2.3	Demo Board Component Layout .....	6
2.4	Demo Board Picture .....	6
2.5	Demo Board PCB Layout .....	7
2.6	Demo Board Bill of Material.....	8
3	DEMO BOARD OPERATING PROCEDURE.....	9
3.1	Load Connection .....	9
3.2	AC Input.....	9
3.3	DC Power Supply Voltage .....	9
3.4	Power-up Sequence .....	10
4	PERFORMANCE CHARACTERIZATION DATA .....	11
4.1	AC Line Voltage and Current Waveforms.....	11
4.2	Output Voltage at AC Line Start Up.....	12
4.3	100% Load Step.....	14
4.4	Power Factor .....	16
4.5	EMI .....	17
5	Demo Board Warnings and Operating Restrictions.....	18

## Table of Figures

Figure 1	- Demo Board Schematic Diagram .....	5
Figure 2	- Demo Board Component Placement .....	6
Figure 3	- Demo Board Photo .....	6
Figure 4	- Demo Board Top Layer Copper.....	7
Figure 5	- Demo Board Bottom Layer Copper.....	7
Figure 6	- VCC connector and test points .....	9
Figure 7	- Recommended Demo Board Test Setup.....	10
Figure 8	- Power Factor vs. Line/Load .....	16
Figure 9	- EMI Plot 115VAC @ 300W Load.....	17

# 1 INTRODUCTION

This document details the IRAC1150-300W Demo Board featuring the IR1150S Power Factor Correction control IC. The document includes a description of the application in addition to schematics, PCB layout, bill of material, design process, and test setup and results.

The IRAC1150-300W Demo Board is designed to demonstrate the performance of the IR1150S control IC in a 300W continuous conduction mode boost converter for power factor correction.

The board is designed for universal AC input and 387VDC output.

**There are high voltages present whenever the board is energized and proper precautions should be taken to avoid potential shock and personal injury.**

## 1.1 Features

- IEC1000-3-2 (EN61000-3-2) Compliant, Low Harmonic Distortion
- Universal Input Voltage
- Regulated 387VDC  $\pm 2.5\%$  Output Voltage
- Current Loop Controlled Power Limiting
- Brownout Protection
- Over voltage Protection
- Open Feedback loop Protection
- 100kHz  $\pm 11\%$  Switching Frequency, (User Programmable from 50kHz to 200kHz)
- High Efficiency IRFP27N60K Power Switch
- Hyper Fast Recovery IR 8ETX06 Boost Diode
- Full Load Start Up
- No Minimum Load Requirements
- Sleep Mode Enable for Low Standby Current Requirement, (Blue Angel, etc.)

## 2 DESCRIPTION

The IR1150S is designed for use in continuous conduction mode boost converter applications for power factor correction and harmonic current reduction. The controller allows for near unity power factor and exceeds all requirements of IEC1000-3-2 (EN61000-3-2) for harmonic distortion.

The IC utilizes trailing edge modulation and peak current mode control to force the input current to follow the sinusoidal input voltage in both shape and phase. The IC incorporates numerous protection features for robust operation and provides a high performance solution while minimizing external components, design time, and printed circuit board real estate, all in an 8 pin SOIC package.

The IR1150S provides a cost effective solution for lower power designs, which are typically dominated by discontinuous mode solutions, as well as high power designs typical of the 16 pin solutions requiring more external components and valuable PCB space.

### 2.1 Demo Board Specifications

AC Line Voltage Range.....	90 – 264VAC
AC Line Frequency Range.....	47 – 63Hz
Converter Switching Frequency.....	100kHz $\pm$ 11%
Output Voltage.....	387VDC $\pm$ 2.5%
Maximum Output Power.....	300W
Minimum Load Requirement.....	None
OVP Threshold (Max).....	418VDC
Efficiency (@ 90VAC / 300W).....	92%
Power Factor (@115VAC / 300W).....	0.999
Operating Ambient Temp Range.....	0 - 40°C

Note: A fan is recommended whenever operating at maximum output power

## 2.2 Schematic

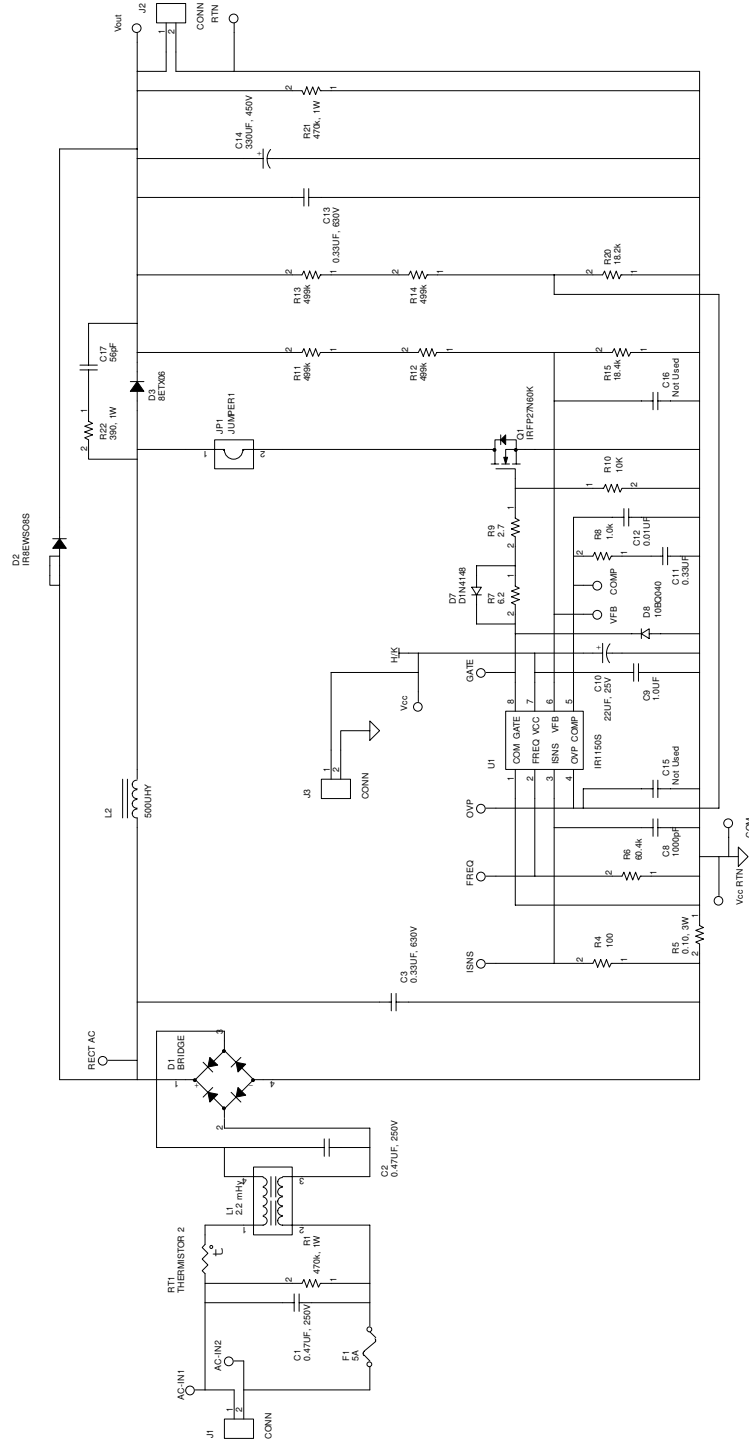

Figure 1 - Demo Board Schematic Diagram

## 2.3 Demo Board Component Layout

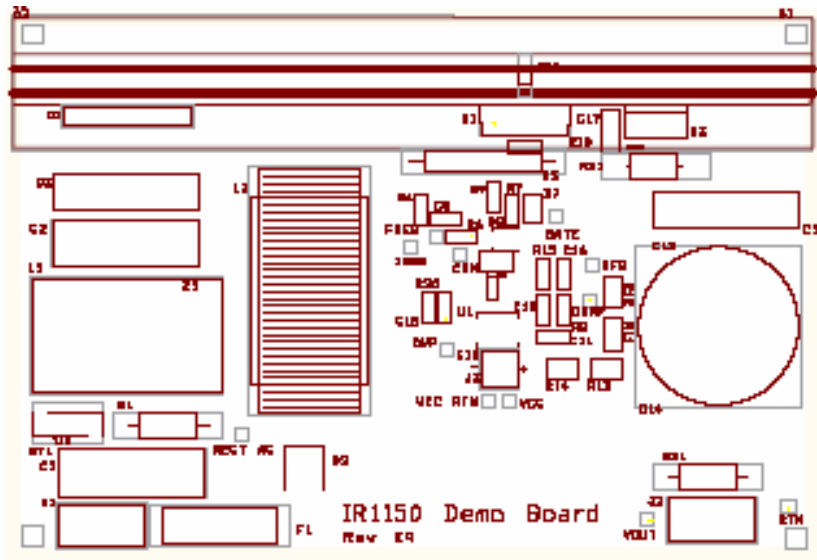

Figure 2 - Demo Board Component Placement

## 2.4 Demo Board Picture

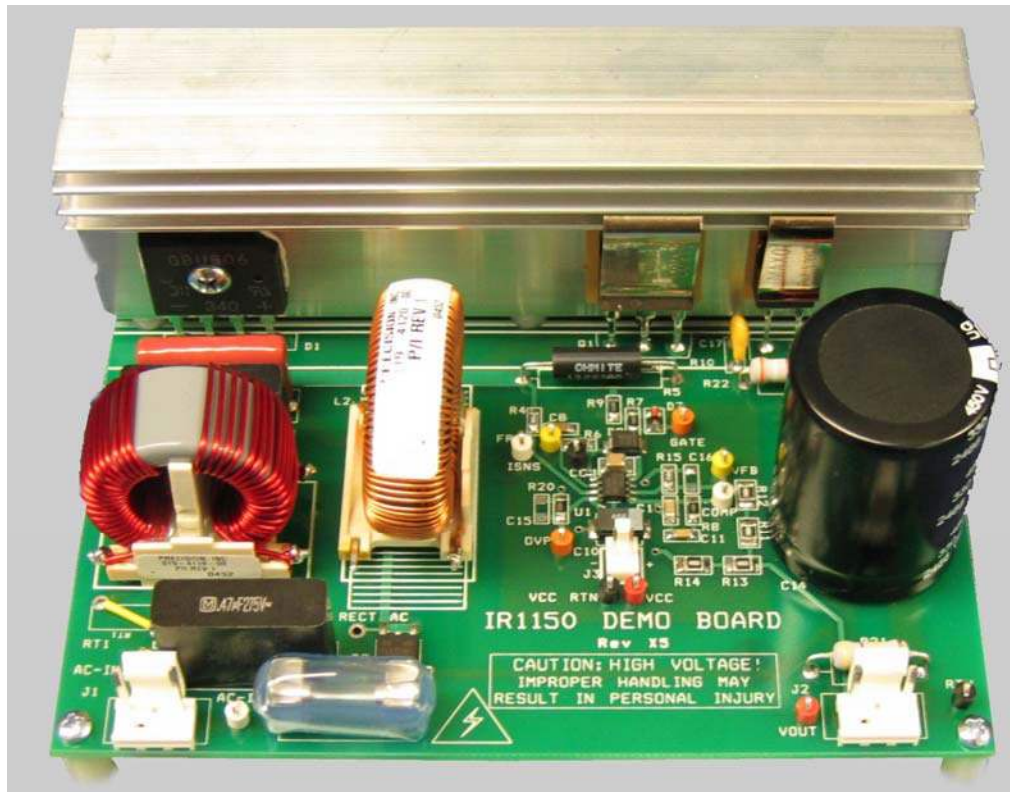

Figure 3 - Demo Board Photo

## 2.5 Demo Board PCB Layout

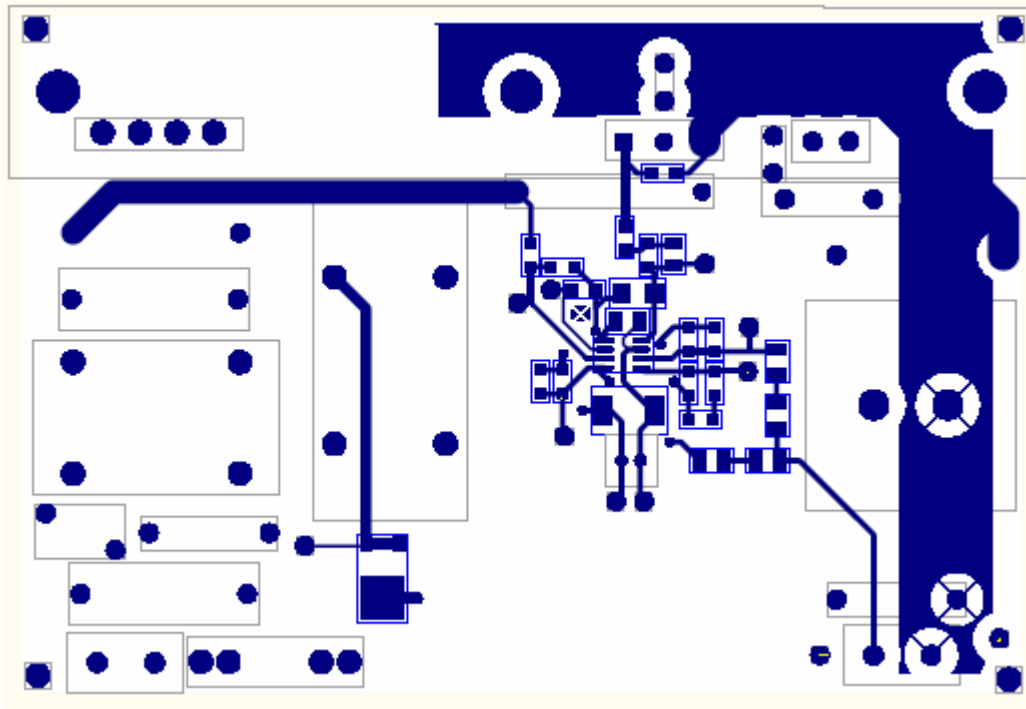

Figure 4 - Demo Board Top Layer Copper

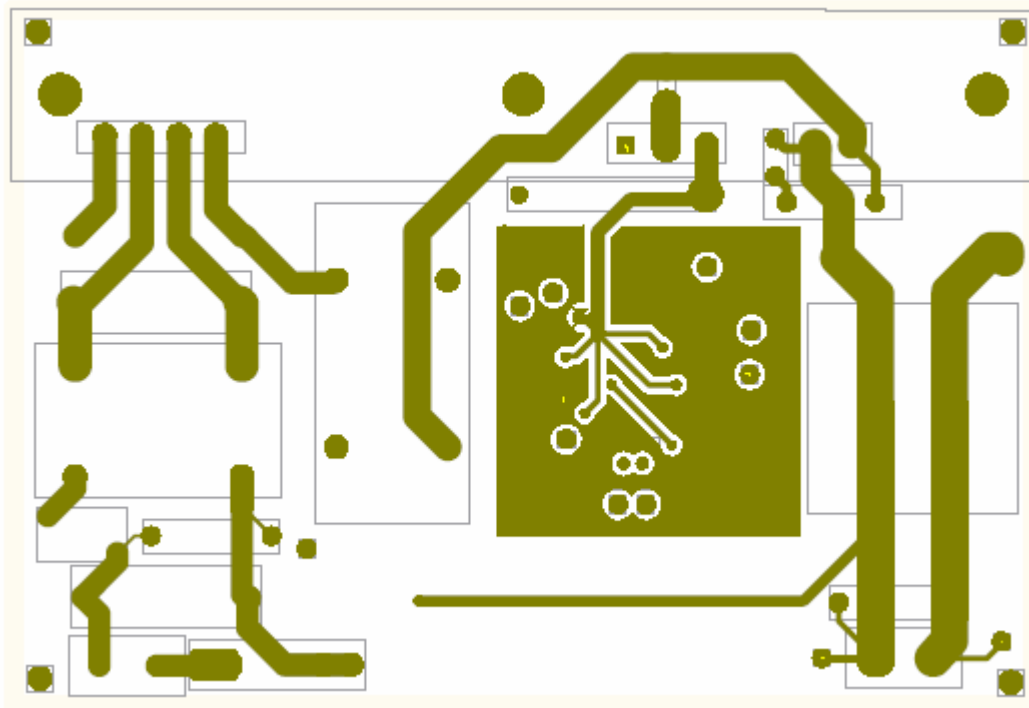

Figure 5 - Demo Board Bottom Layer Copper

## 2.6 Demo Board Bill of Material

IRAC1150-300W DEMO BOARD - BILL OF MATERIAL						
REV: D						
	LOCATION	DESCRIPTION	SIZE:	QTY:	VENDOR	PART NUMBER
1	U1	IR1150 Control IC	SO8	1	IR	IR1150S
2	R1, R21	470K Ohm metal film 1W 5%	Thru Hole	2	DIGI-KEY	BC470KW-1CT-ND
3	R4	100 Ohm 1/4W 1%	1206 SMD	1	DIGI-KEY	311-100FCT-ND
4	R5	CURRENT SENSE .10 OHM 3W	Thru Hole	1	DIGI-KEY	13FR100-ND
5	R6	78.7K OHM 1/4W 1%	1206 SMD	1	DIGI-KEY	311-78.7KFCT-ND
6	R7	6.20 OHM 1/4W 1%	1206 SMD	1	DIGI-KEY	311-6.20FCT-ND
7	R8	8.87K OHM 1/4W 1%	1206 SMD	1	DIGI-KEY	311-8.87KFCT-ND
8	R9	2.70 OHM 1/4W 1%	1206 SMD	1	DIGI-KEY	311-2.70FCT-ND
9	R10	10.0K OHM 1/4W 1%	1206 SMD	1	DIGI-KEY	311-10.0KFCT-ND
10	R11 - R14	499K OHM 1/4W 1%	1210 SMD	4	DIGI-KEY	P499KAACT-ND
11	R15	18.4K OHM 1/4W 0.1%	1206 SMD	1	TTI	TNPW120618K4BETY
12	R20	18.2K OHM 1/4W 0.1%	1206 SMD	1	TTI	TNPW120618K2BEEN
13	R22	390 OHM METAL FILM 1W 5%	Thru Hole	1	DIGI-KEY	BC390W-1CT-ND
14	C1, C2	.47UF 250/275VAC ECQ-UL	Thru Hole	2	DIGI-KEY	P10734-ND
15	C3, C13	.33UF/630VAC METAL POLY CAP	Thru Hole	2	DIGI-KEY	EF6334-ND
16	C8	1000PF 50V CERM CHIP	1206 SMD	1	DIGI-KEY	PCC102BCT-ND
17	C9	1UF 50V CERAMIC X5R	1210 SMD	1	DIGI-KEY	PCC2303CT-ND
18	C10	22UF 35V TANTALUM TEL SMD	2010 SMD	1	DIGI-KEY	P11302CT-ND
19	C11	.33UF 25V CERAMIC X7R	1206 SMD	1	DIGI-KEY	PCC1889CT-ND
20	C12	.01UF 10% 50V X7R	1206 SMD	1	DIGI-KEY	478-1542-1-ND
21	C14	330UF 450V ELECT TS-UQ	Thru Hole	1	DIGI-KEY	P11947-ND
22	C15, C16	NOT USED	N/A	N/A	N/A	N/A
23	C17	56PF 1KVDC CERAMIC SL/GP 5%	Thru Hole	1	DIGI-KEY	P10801-ND
24	D1	RECT BRIDGE GPP 600V 8A GBU	Thru Hole	1	DIGI-KEY	GBU806DI-ND
25	D2	DIODE STD REC 800V 8A D-PAK	D-PAK	1	DIGI-KEY	8EWS08S-ND
26	D3	DIODE HYPERFAST 600V 8A TO-220AC	Thru Hole	1	DIGI-KEY	8ETX06-ND
27	D7	RECTIFIER SILICON .15A 75V	MINIMELF	1	DIGI-KEY	DL4148MSCT-ND
28	D8	DIODE SCHOTTKY 40V 1A SMB	2010 SMD	1	DIGI-KEY	10BQ040-ND
29	Q1	IRFP27N60K	Thru Hole	1	IR	IRFP27N60K
30	L1	EMI Common Mode Choke - 2.2MHY	Thru Hole	1	PRECISION	019-4119-00
31	L2	500UHY BOOST CHOKE	Thru Hole	1	PRECISION	019-4120-00
32	F1	FUSE 5A/250V 5X20MM FAST ACT	GLASS FUSE	1	DIGI-KEY	F952-ND
33	F1 CLIP	CLIP FUSE 10A 5X20MM PC MOUNT	Thru Hole	2	DIGI-KEY	F063-ND
34	FUSE COVER	COVER FUSE VINYL 5MM	VINYL	1	DIGI-KEY	3527CK-ND
35	J1, J2	CONN HEADER 3POS.156 VERT TIN	Thru Hole	2	DIGI-KEY	WM4621-ND
36	J3	CONN HEADER 2POS.100 VERT TIN	Thru Hole	1	DIGI-KEY	WM4200-ND
37	RTN, VCC RTN, COM	TEST POINT PC COMPACT .063"D BLK	Thru Hole	3	DIGI-KEY	5006K-ND
38	VOUT, VCC	TEST POINT PC COMPACT .063"D RED	Thru Hole	2	DIGI-KEY	5005K-ND
39	OVP, GATE	TEST POINT PC COMPACT .063"D ORN	Thru Hole	2	DIGI-KEY	5008K-ND
40	AC-IN1, FREQ, VFB	TEST POINT PC COMPACT .063"D YLW	Thru Hole	3	DIGI-KEY	5009K-ND
41	AC-IN2, ISNS, COMP	TEST POINT PC COMPACT .063"D WHT	Thru Hole	3	DIGI-KEY	5007K-ND
42	THERMAL INSUL	BERGQUIST SIL-PAD K10 (For Q1)	TO-247	1	BERGQUIST	BG80269 (K10-104 no hole)
43	THERMAL INSUL	BERGQUIST SIL-PAD K10 (For D3)	TO-220	1	BERGQUIST	K10-43
44	HEATSINK	AAVID 78060 Extrusion	5.5"	1	AAVID	NP974752
45	SPACER ROUND	SPACER ROUND #6 SCREW NYLON CLR	Thru Hole	2	DIGI-KEY	883K-ND
46	HEATSINK SCREW	SCREW, MACHINE, PHILLIPS 6-32X5/16	6-32x5/16	3	DIGI-KEY	H355-ND
47	JP1	0.2" 18GA LONG JUMPER WIRE	.2"	1	DIGI-KEY	923345-02-ND
48	STANDOFF HEX.	STANDOFF HEX .500/4-40THR NYLON	.500"4-40	4	DIGI-KEY	1902CK-ND
49	STANDOFF SCREW	SCREW, MACHINE, PHIL 4-40x5/16SS	4-40x5/16	4	DIGI-KEY	H704-ND
50	Q1 Clip TO-247	AAVID MAX CLIP 03	TO-247	1	MOUSER	532-MAXCLIP03
51	D3 Clip-TO220	AAVID MAX CLIP 01	TO-220	1	MOUSER	532-MAXCLIP01
52	PCB	IRAC1150-300W Rev D	5.5 x 3.75	1	Advanced	IRAC1150-300W_D
53	D1 SREW	SCREW, MACHINE, PHILLIPS 6-32x1/4	6-32x1/4	1	DIGI-KEY	H354-ND
54	RT1 JUMPER	JUMPER, 0.4" - RT1	0.4"	1	DIGI-KEY	923345-04-ND
55	Thermal Compound	Aavid Thermalloy ThermalCote 251	For D1	A/R	AAVID	ThermalCote 251



### 3 DEMO BOARD OPERATING PROCEDURE

**CAUTION: Potentially lethal voltages exist on this demo board when powered up. Improper or unsafe handling of this board may result in serious injury or death.**

The recommended test setup is shown in Figure 7.

#### 3.1 Load Connection

Connect resistive or electronic load, capable of 300W continuous power, to J2-1 (+) and J2-2 (-). Output voltage is monitored at Test Points  $V_{OUT}$  and RTN. There is no minimum load requirement.

*There is a 475k $\Omega$  bleed resistor on the output of the converter. Always monitor the output voltage to ensure that output voltage has discharged completely prior to adding or removing load connections from the demo board, or contacting the output connector in any way*

**Failure to follow these precautions may result in serious injury.**

#### 3.2 AC Input

Connect a 50/60Hz AC power source, capable of operation up to 264Vrms, to J1-1 and J1-2.

There is no inrush current protection circuitry to protect power train components from inrush current at initial application of full AC line voltage. A footprint for an NTC resistor is available but currently shorted.

Once power is applied to demo board, potentially lethal high voltages will be present on board and necessary precautions should be taken to avoid serious injury.

*The use of an isolation transformer on the AC side is highly recommended, so that all the control signals on the test points can easily be probed by using regular scope probes, and as an overall additional margin of safety to reduce potential shock hazard from high voltages.*

**Improper handling of demo board can result in injury or death.**

#### 3.3 DC Power Supply Voltage

To bias the demo board, apply external DC voltage to connector J3 or alternatively between Test Points  $V_{CC}$  (+) and  $V_{CC}$  RTN(-): The recommended voltage is 14V while a maximum voltage of 22V can be applied without damaging the IC.

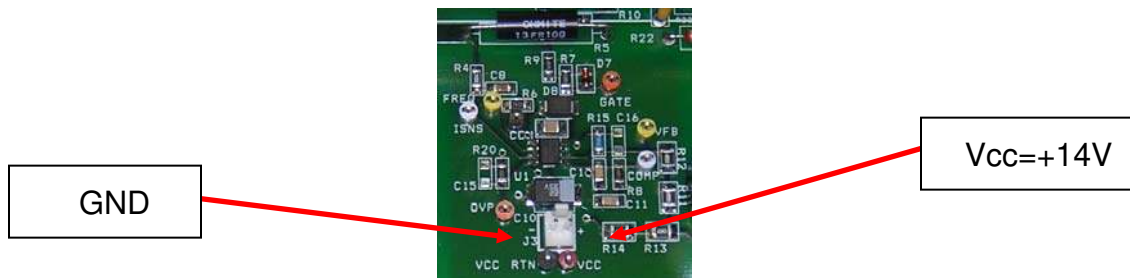

Figure 6 - VCC connector and test points

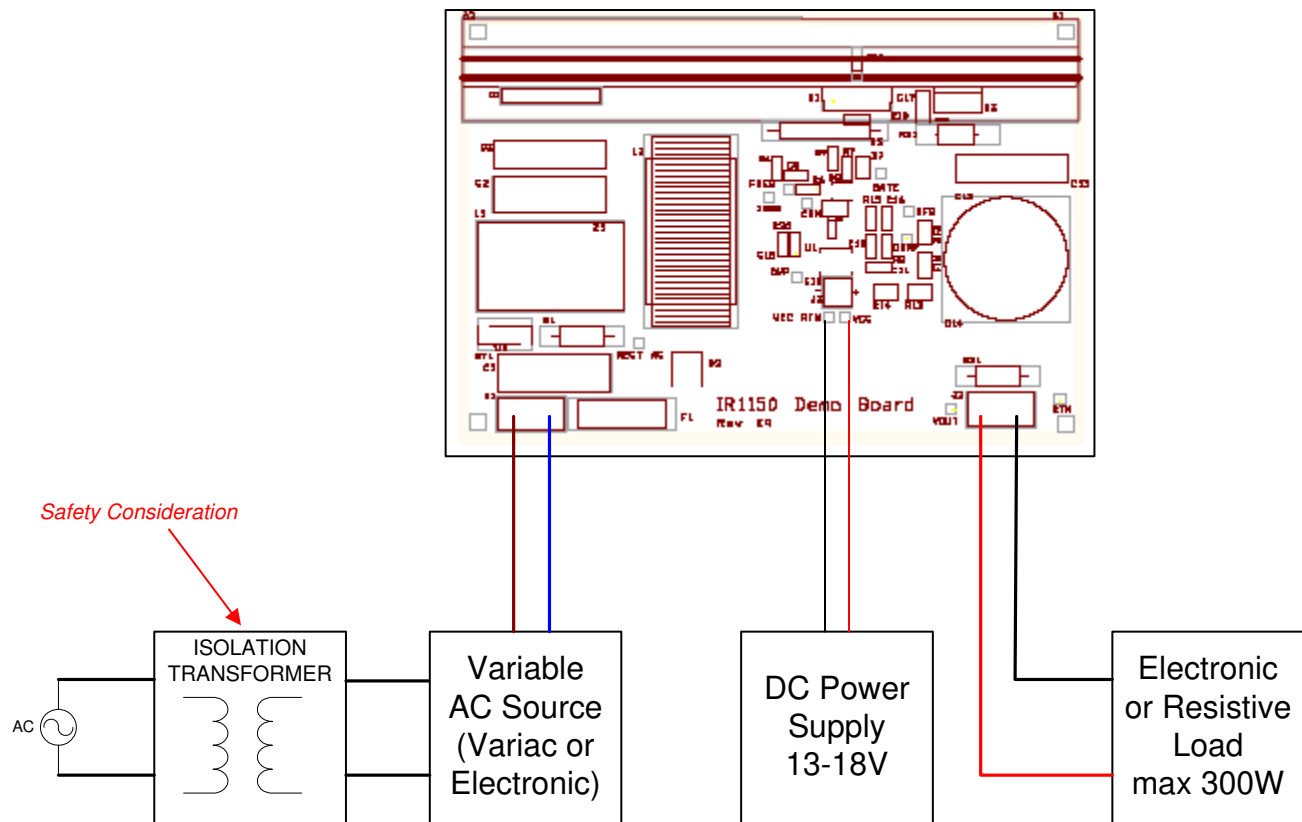

Figure 7 - Recommended Demo Board Test Setup

***Isolation transformer highly recommended in order to reduce shock hazard from potentially lethal voltages***

### 3.4 Power-up Sequence

Once all the connections are made the system can be powered up. Power up the DC supply for the control circuitry and then provide AC voltage. This sequence is not strictly necessary and the AC can be provided before powering up the control circuitry.

If the AC line is increased gradually the converter will start boosting around an AC voltage of 55Vrms or whenever the output voltage reaches 20% of the programmed output voltage.

# 4 PERFORMANCE CHARACTERIZATION DATA

## 4.1 AC Line Voltage and Current Waveforms

**Ch2** – AC Line Voltage      **Ch3** – AC Line Current

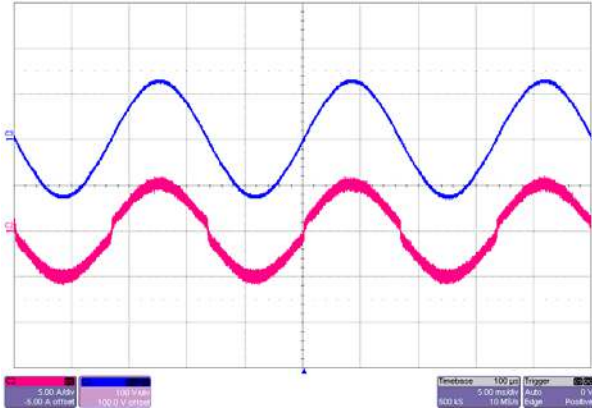

90VAC @ 300W Load

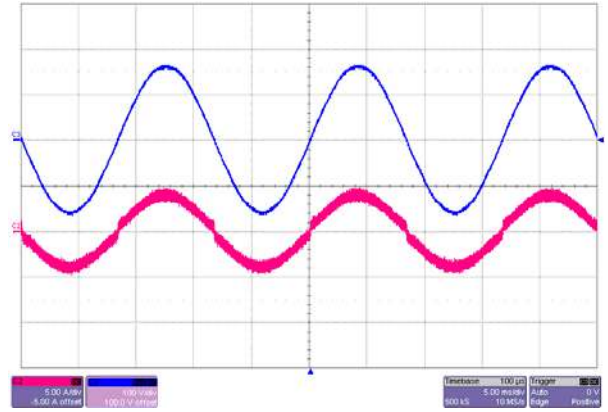

115VAC @ 300W Load

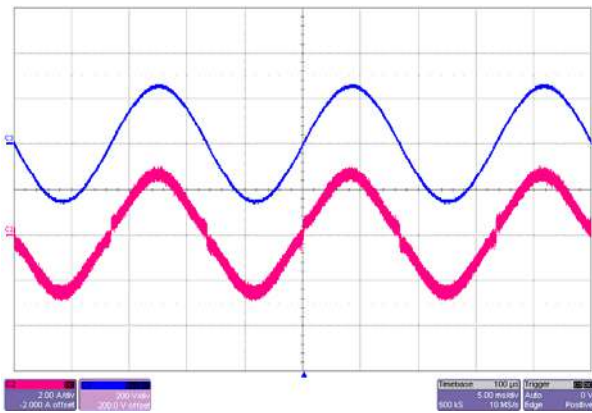

180VAC @ 300W Load

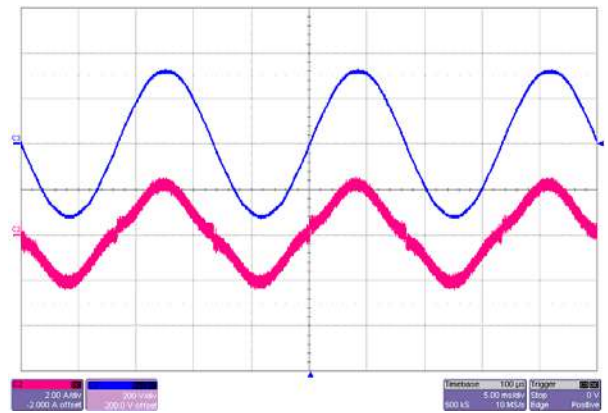

230VAC @ 300W Load

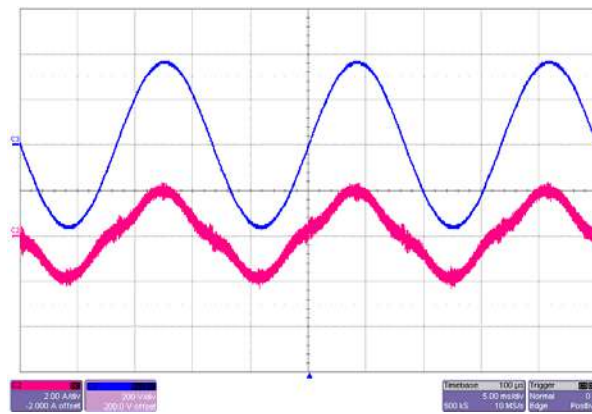

264VAC @ 300W Load

## 4.2 Output Voltage at AC Line Start Up

In this section the results for startup at different load and line conditions are reported. The initial inrush current (bulk cap charging current) will not be limited by the circuit. The board is able to withstand a full load startup without damage.

**Ch 2** – AC Line Voltage    **Ch 3** – AC Line Current    **Ch 4** – DC Output Voltage

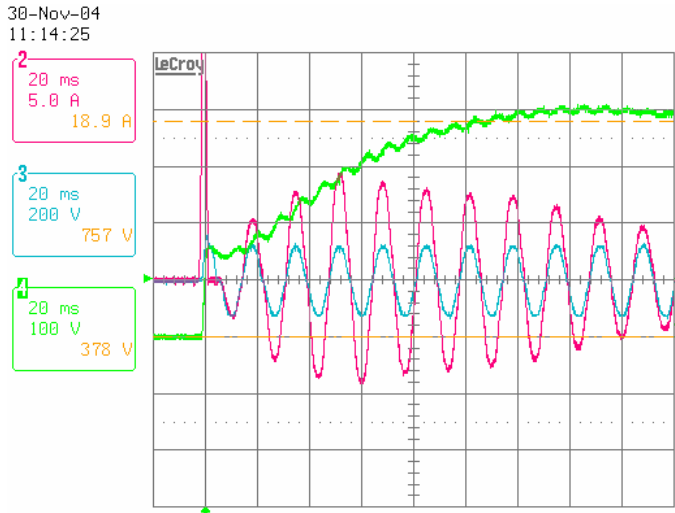

90VAC Startup @ 300W Load

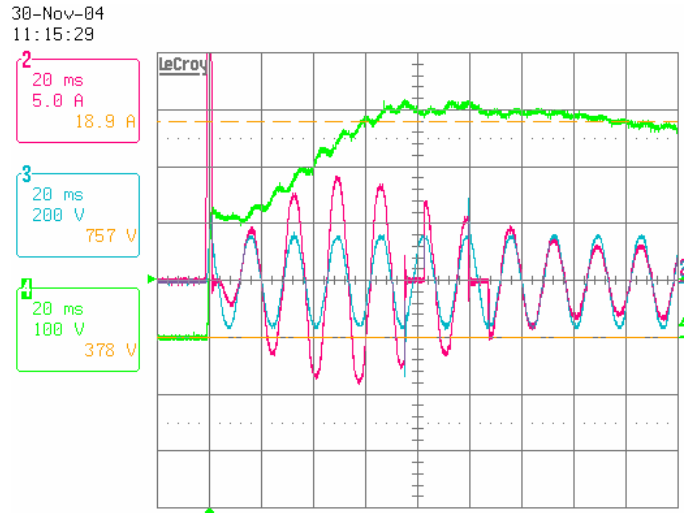

115VAC Startup @ 300W Load

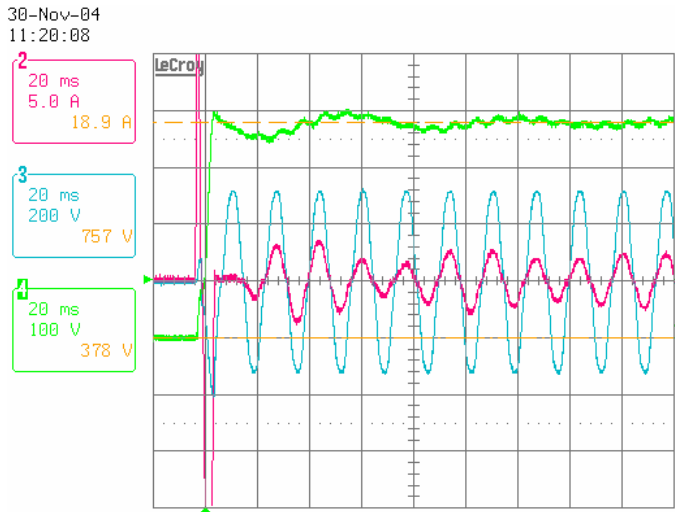

230VAC Startup @ 300W Load

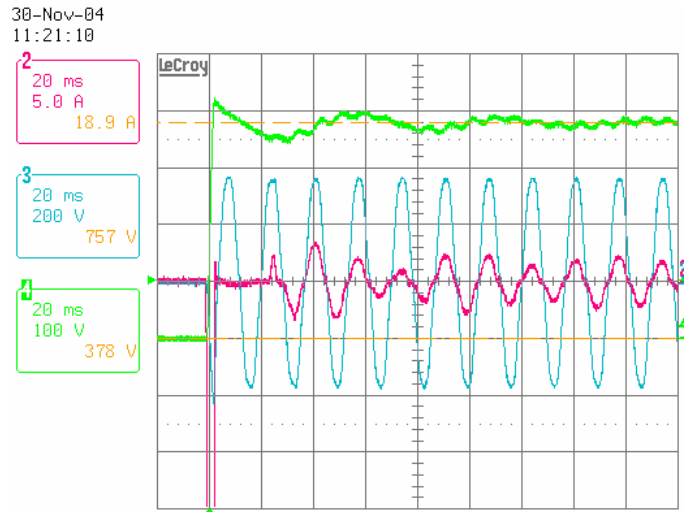

264VAC Startup @ 300W Load

30-Nov-04  
11:23:07

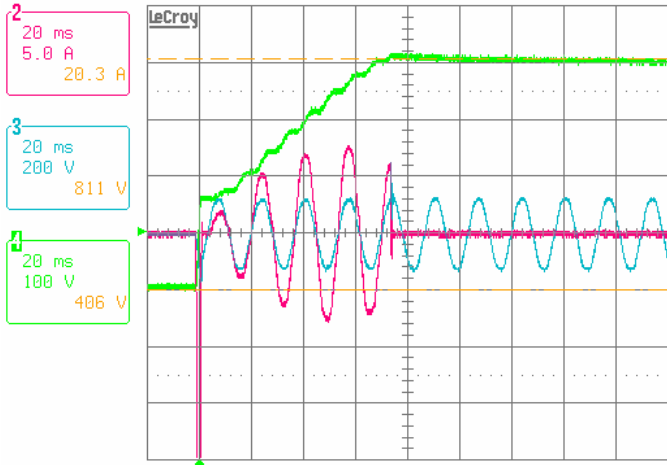

90VAC Startup @ No Load

30-Nov-04  
11:24:24

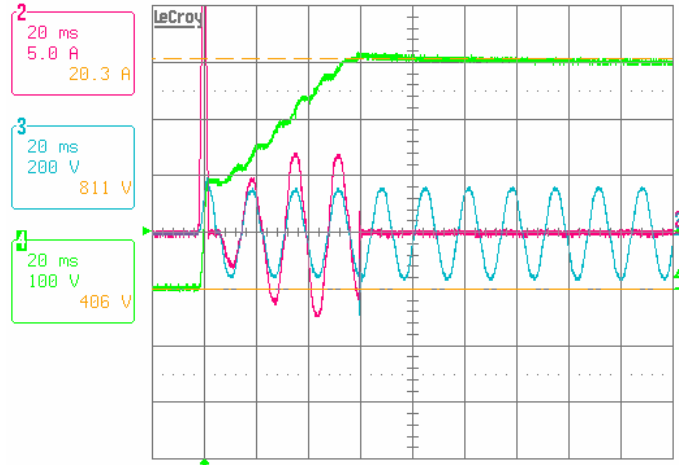

115VAC Startup @ No Load

30-Nov-04  
11:26:24

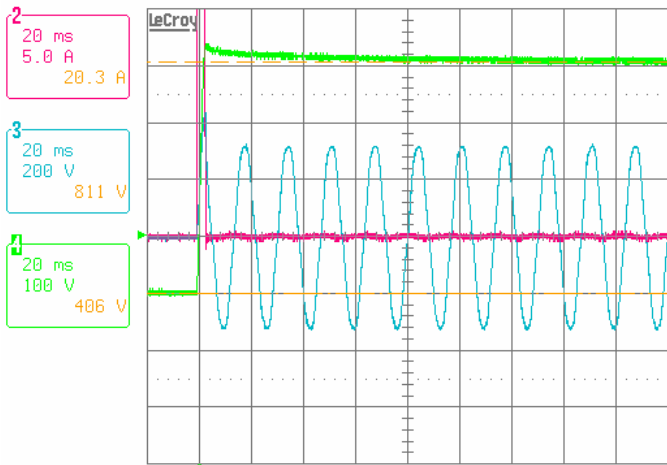

230VAC Startup @ No Load

30-Nov-04  
11:27:24

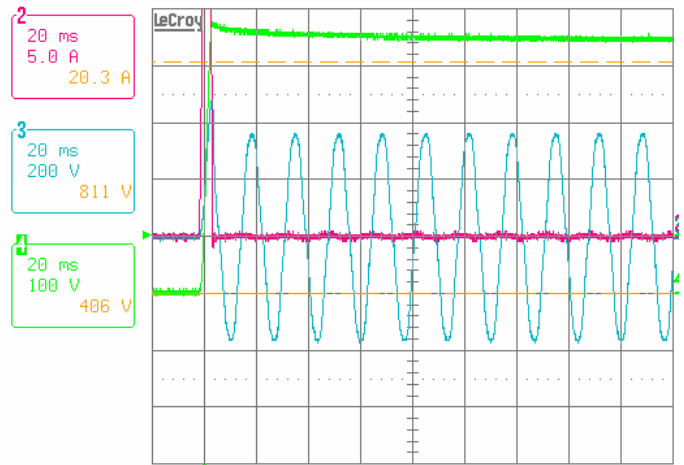

264VAC Startup @ No Load

### 4.3 100% Load Step

A load step from full load to no load and from no load to full load was applied at different AC line voltages, to test the dynamic response.

**Ch 1:** Output Voltage AC Coupled -- **Ch 2:** AC Line Voltage

**Ch 3:** AC Line Current **Ch 4:** DC Output Voltage

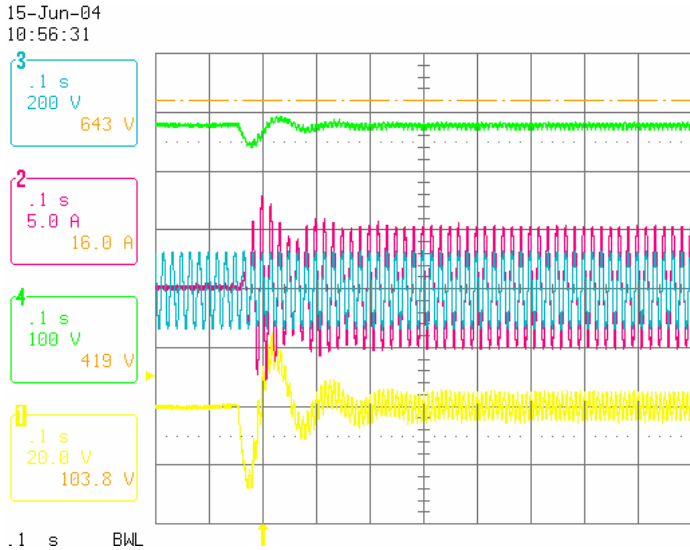

No Load to 300W Step @ 90VAC

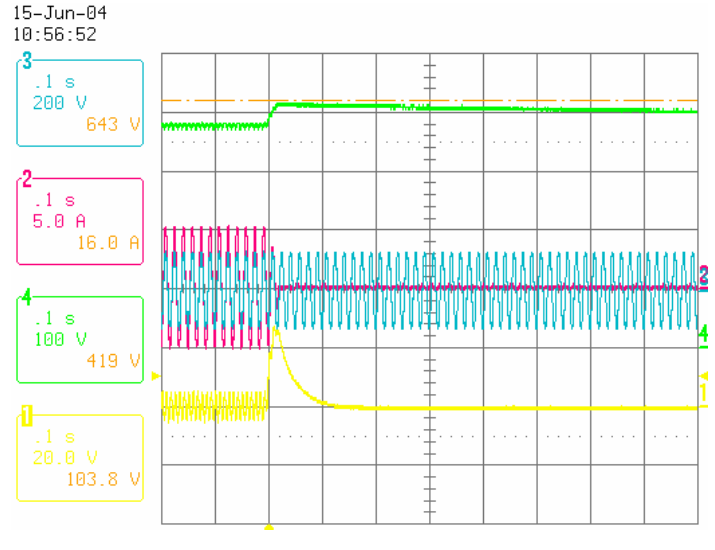

300W to No Load Step @ 90VAC

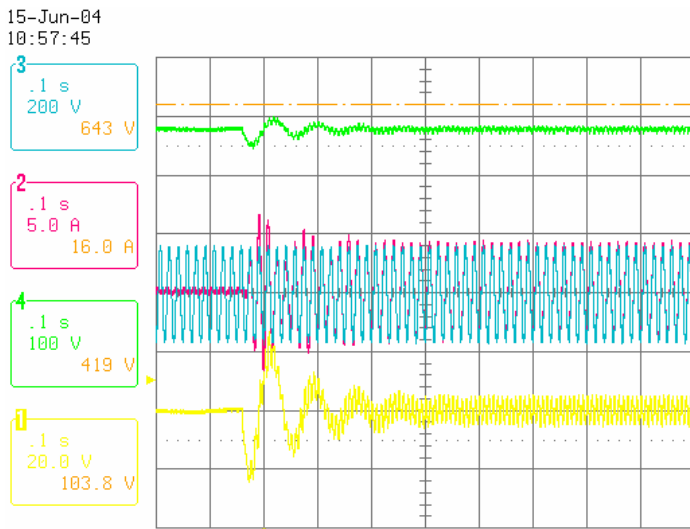

No Load to 300W Step @ 115VAC

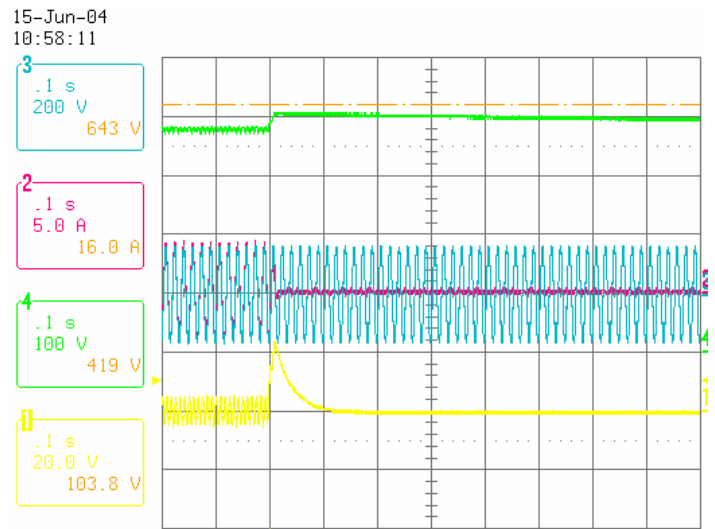

300W to No Load Step @ 115VAC

15-Jun-04  
10:58:51

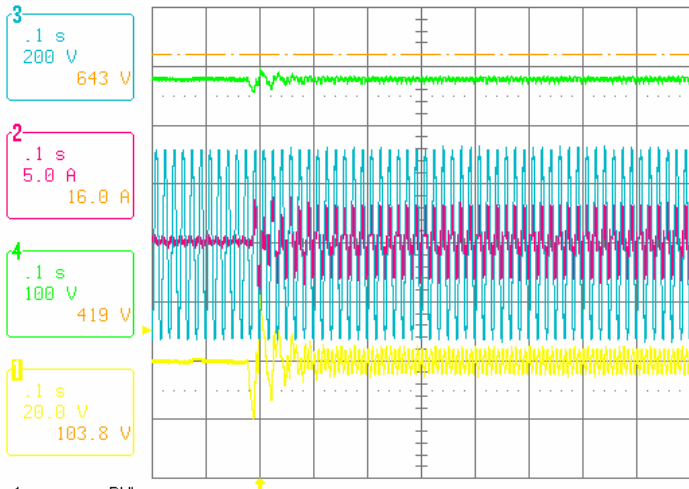

No Load to 300W Step @ 230VAC

15-Jun-04  
10:59:14

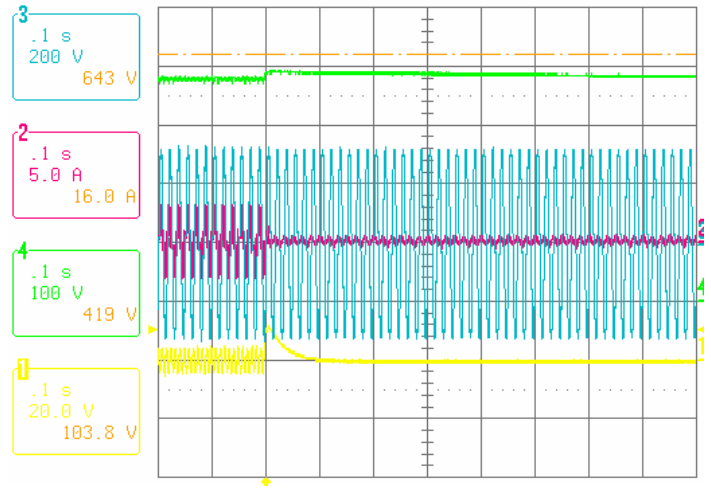

300W to No Load Step @ 230VAC

15-Jun-04  
10:59:43

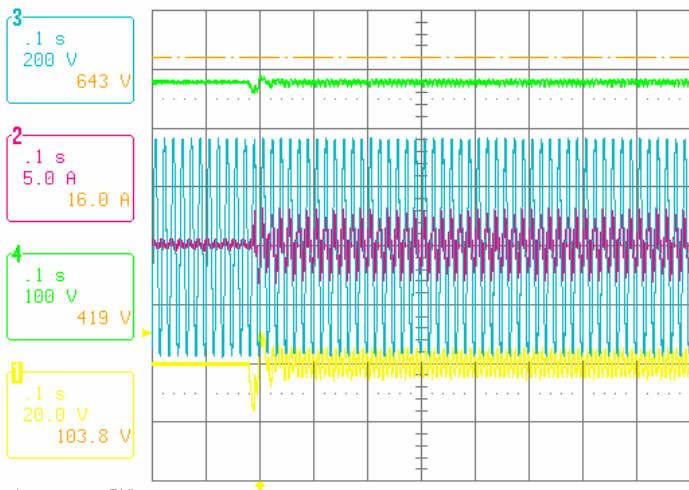

No Load to 300W Step @ 264VAC

15-Jun-04  
11:00:07

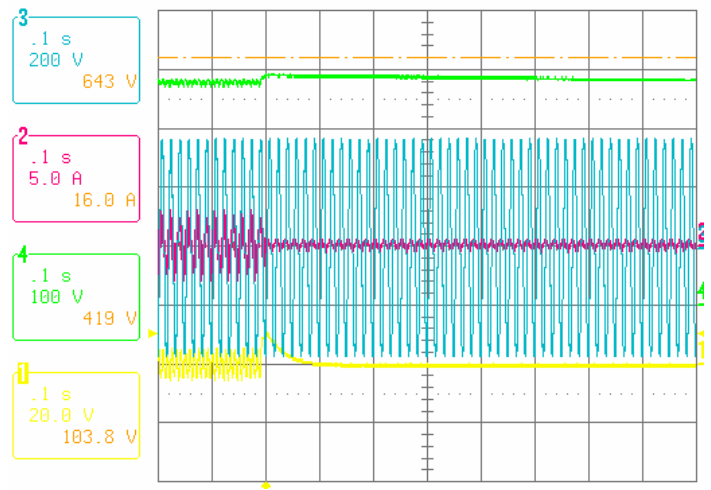

300W to No Load Step @ 264VAC

## 4.4 Power Factor

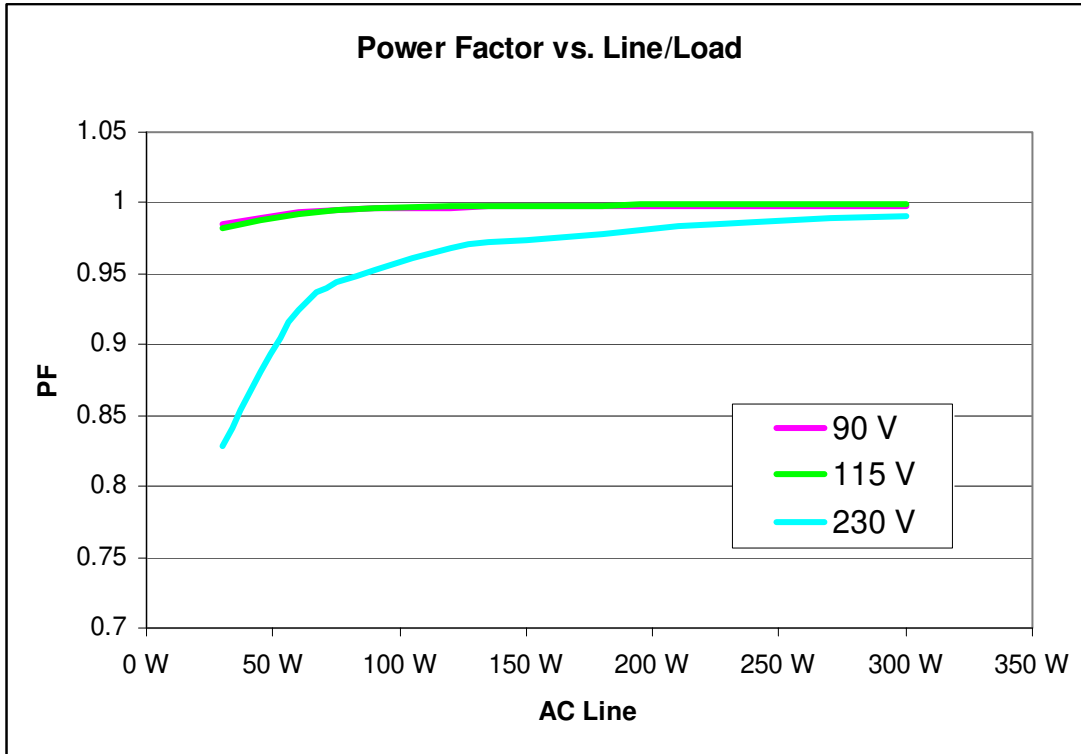

Figure 8 - Power Factor vs. Line/Load

Table 1 – Power Factor vs. Line/Load

Pout/Vin	90 V	115 V	230 V
30 W	0.985	0.9816	0.8284
60 W	0.994	0.9923	0.9237
90 W	0.9961	0.996	0.9529
120 W	0.9966	0.9973	0.968
150 W	0.9981	0.9979	0.9737
180 W	0.9982	0.9981	0.9786
210 W	0.9981	0.9985	0.9831
240 W	0.9981	0.9989	0.9864
270 W	0.9981	0.9991	0.9891
300 W	0.9981	0.999	0.991



## 4.5 EMI

EMI has been tested for Quasi-Peak conducted noise, completely open frame with no chassis ground. Although limits are exceeded (CISPR-22 Class B), it must be considered that the use of metal enclosure and Y caps should easily improve the situation.

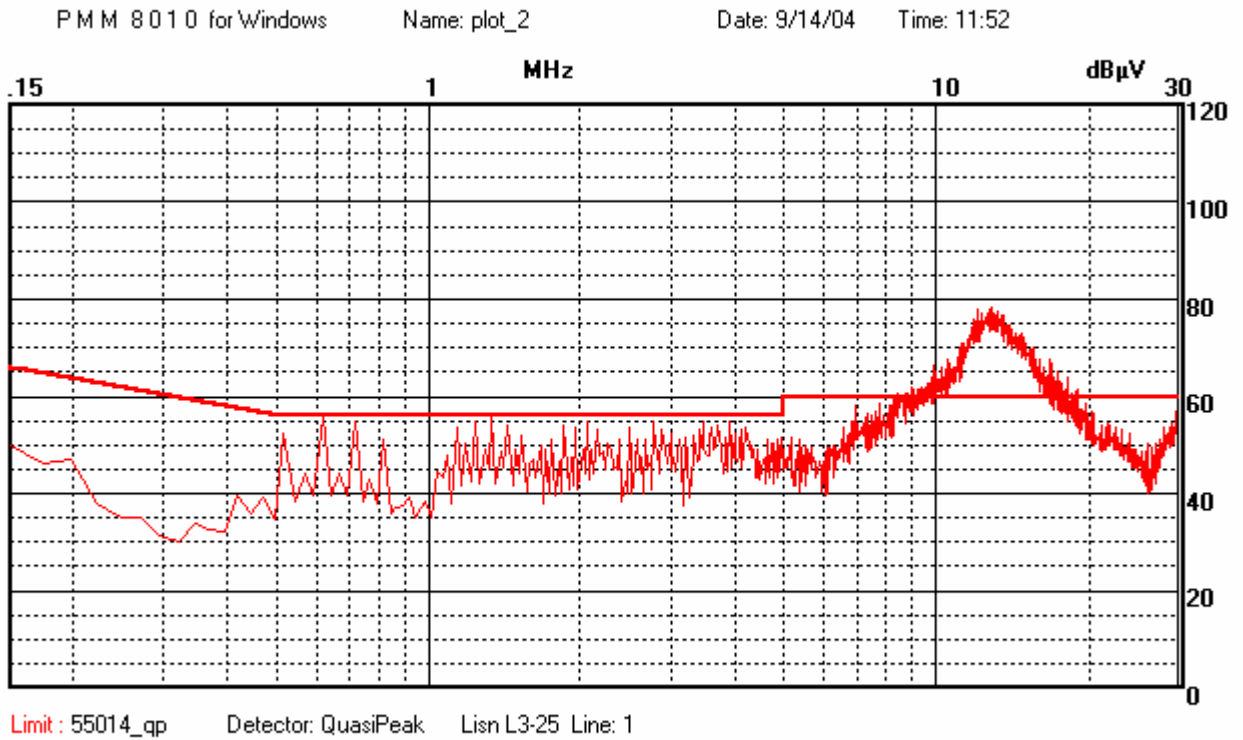

**Figure 9 - EMI Plot 115VAC @ 300W Load**

## 5 Demo Board Warnings and Operating Restrictions

The IRAC1150-300W Demo Board is designed for universal input voltage range of 85Vrms to 264Vrms, and 387VDC  $\pm$ 2.5% output voltage. Operation outside the specified operating range of input voltage may result in unpredictable behavior, and/or catastrophic failure of demo board and load. Should questions arise with regard to input voltage range, please contact an IR Field Applications Engineer for support, prior to application of AC power.

The IRAC1150-300W Demo Board is designed for continuous operation at 300W load. Operation outside the specified load range may result in unpredictable behavior, and/or catastrophic failure of demo board and load. Should questions arise with regard to output power ratings and capability, please contact an IR Field Applications Engineer for support, prior to connection of load to Demo Board. It should be noted that high voltage levels can exist at output connection for some time following removal of AC power at input. Take necessary steps, (monitor output voltage), to ensure voltage level is safe prior to application or removal of load connection.

During normal operation within the specified operating ranges, demo board components and heat sink may yield case temperatures in excess of 50°C. Demo Board components operating at case temperatures greater than 50°C are within their maximum thermal limits, so long as Demo Board is operating within specified input voltage and output power limits. Nevertheless, these devices will be hot to the touch and contact should be avoided at all times. Care should be taken whenever placing or removing measuring probes anywhere on the demo board, particularly near devices yielding elevated temperatures.

*An isolation transformer is highly recommended to reduce the likelihood of injury due to electrical shock and/or damage to the demo board when using oscilloscope probes.*

*It is a good safety practice to avoid any personal contact with the Demo Board whenever it is powered up under AC input voltage. Following this important guideline will greatly reduce the chance of personal injury due to electrical shock and/or burn.*

For additional margin of safety, International Rectifier AC-DC Applications Team suggest the following guidelines for safe operation and handling of IRAC1150-300W Demo Board;

- Avoid personal contact with Demo Board whenever AC voltage is applied
- Turn off Demo Board when placing or removing measurement probes
- Always wear safety glasses whenever operating Demo Board
- Always monitor input and output voltages to ensure safe removal from, and/or connection to, input and output connectors
- Pay close attention and use caution whenever working around operating Demo Board