

PART NUMBER (FROM 20Pos. TO 40Pos.)
10159549-120XXLF ~ 10159549-140XXLF

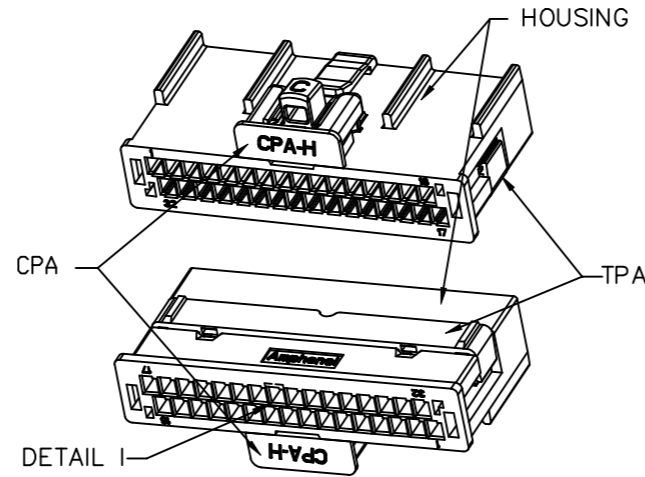
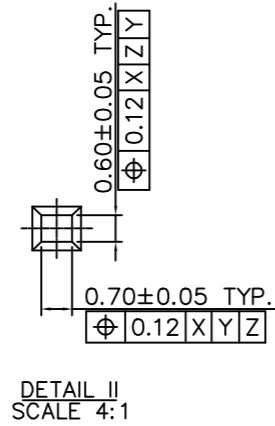
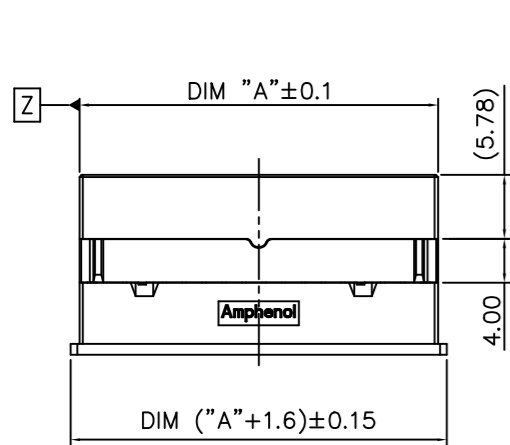
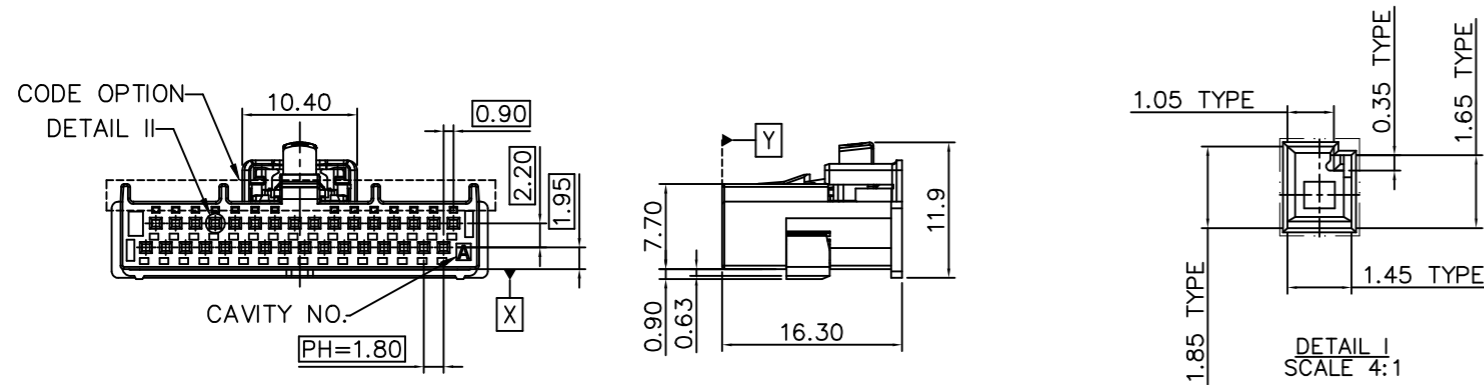

10159549-132XALF

POS.	PART NO.	DIM "A"	POS.	PART NO.	DIM "A"	POS.	PART NO.	DIM "A"
20	10159549-120XALF	21.70	28	10159549-128XALF	28.90	36	10159549-136XALF	36.10
	10159549-120XBLF			10159549-128XBLF			10159549-136XBLF	
	10159549-120XCFL			10159549-128KCFL			10159549-136XCFL	
	10159549-120XDLF			10159549-128KDLF			10159549-136XDLF	
22	10159549-122XALF	23.50	30	10159549-130XALF	30.70	38	10159549-138XALF	37.90
	10159549-122XBLF			10159549-130XBLF			10159549-138XBLF	
	10159549-122XCFL			10159549-130XCFL			10159549-138XCFL	
	10159549-122XDLF			10159549-130XDLF			10159549-138XDLF	
24	10159549-124XALF	25.30	32	10159549-132XALF	32.50	40	10159549-140XALF	39.70
	10159549-124XBLF			10159549-132XBLF			10159549-140XBLF	
	10159549-124XCFL			10159549-132XCFL			10159549-140XCFL	
	10159549-124XDLF			10159549-132XDLF			10159549-140XDLF	
26	10159549-126XALF	27.10	34	10159549-134XALF	34.30	REMARK, THIS SHEET SHOWS 20Pos. TO 40Pos.		
	10159549-126XBLF			10159549-134XBLF				
	10159549-126XCFL			10159549-134XCFL				
	10159549-126XDLF			10159549-134XDLF				

NOTES:

- 1 - MATERIAL: THERMOPLASTIC UL94V-0
COLOR: FOUR COLORS, DETAIL SEE TABLE
- 2 - PACKAGING SPEC: GS-14-2668
- 3 - PART NUMBER CODE: 10159549-1 XX X X LF

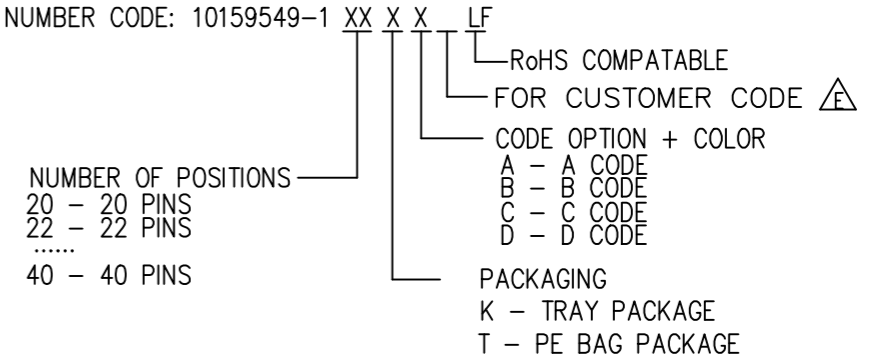

A CODE / COLOR: BLACK	B CODE / COLOR: GREEN; COLOR CODE: RAL6002
C CODE / COLOR: WHITE; COLOR CODE: RAL9001	D CODE / COLOR: BORDEAUX; COLOR CODE: RAL4004
REMARK, THIS SHEET SHOWS 20Pos. TO 40Pos.	

mat'l. code		surface		tolerance		projection		product family	
		ISO 1302 ✓		ISO 406/ISO 1101				HPL649	
ltr		ecn no		dr		date		title	
A		NEW DRAWING RELEASE		DW		10/23/2020		RECEPTACLE KITS, DUAL ROW, WITH CPA	
B		ELX-N-40676		DW		4/13/2021		WireLock® Series Cable Kits	
C		ELX-N-46633		DW		10/28/2022		dwg no	
D		ELX-N-47865		JWZ		3/18/2023		sheet 1 of 4	
E		ELX-N-48616		JWZ		6/29/2023		size	
				dr		DAISY WU		10159549	
				engr		NICK ZHANG		A4	
				chr		ZK HU		type	
				appd		TIM YAO		Product Customer Drawing	
sheet index		revision sheet		E		1~4			

PART NUMBER (FROM 18Pos.)

10159549-118XXLF

NOTES:

1 - MATERIAL: THERMOPLASTIC UL94V-0
COLOR: FOUR COLORS, DETAIL SEE TABLE

2 - PACKAGING SPEC: GS-14-2668

3 - PART NUMBER CODE: 10159549-1 18 X X LF

RoHS COMPATIBLE
FOR CUSTOMER CODE Δ
CODE OPTION + COLOR
A - A CODE
B - B CODE
C - C CODE
D - D CODE
PACKAGING
K - TRAY PACKAGE
T - PE BAG PACKAGE

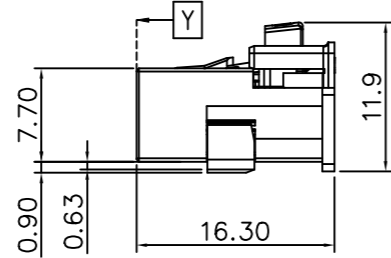
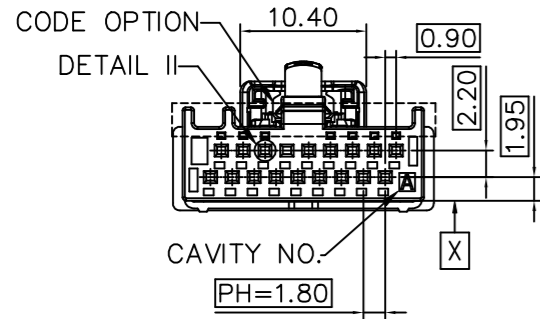

NUMBER OF POSITIONS
18 - 18 PINS

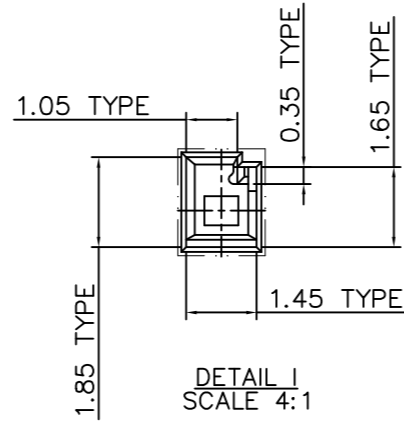
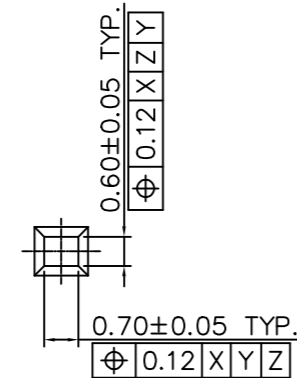
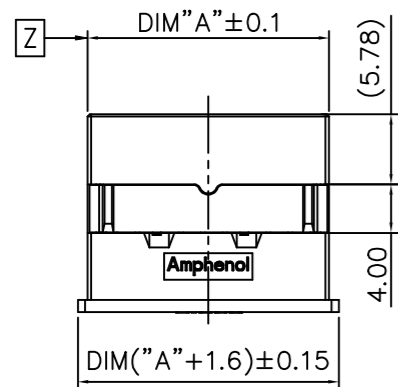

DETAIL II
SCALE 4:1

DETAIL I
SCALE 4:1

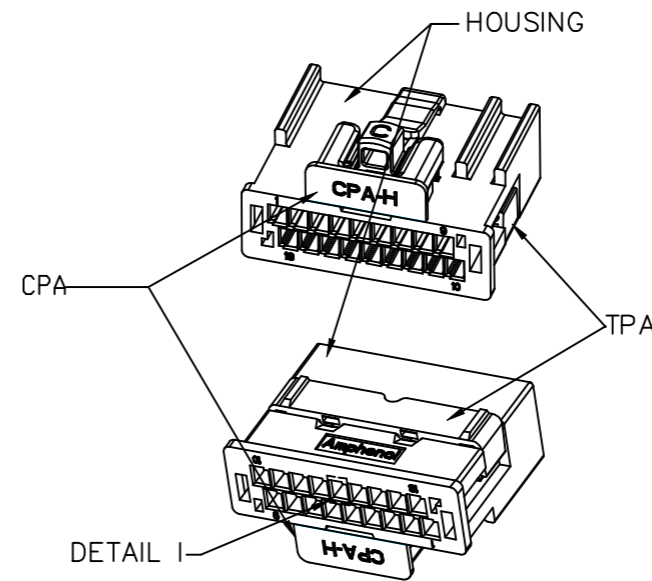

10159549-118XALF

POS.	PART NO.	DIM "A"
18	10159549-118XALF	19.90
	10159549-118XBLF	
	10159549-118XCLF	
	10159549-118XDLF	

REMARK,
THIS SHEET SHOWS 18Pos.

A CODE / COLOR: BLACK

B CODE / COLOR: GREEN; COLOR CODE: RAL6002

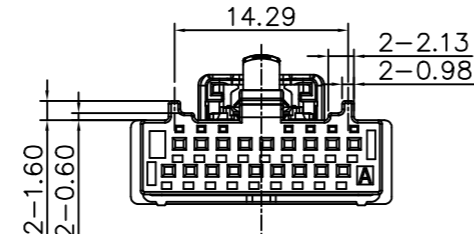
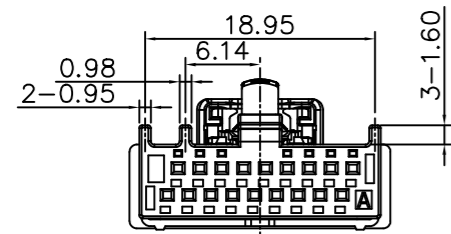

C CODE / COLOR: WHITE; COLOR CODE: RAL9001

D CODE / COLOR: BORDEAUX; COLOR CODE: RAL4004

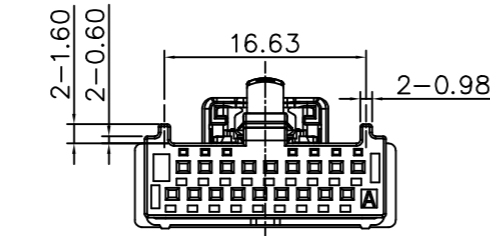
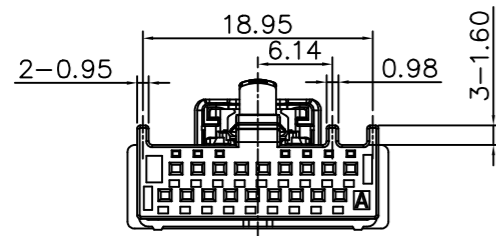

REMARK, THIS SHEET SHOWS 14Pos. TO 18Pos.

mat'l. code		surface	tolerance	projection	product family
		ISO 1302	ISO 406/ISO 1101		HPL649
ltr	ecn no	dr	date	tolerances unless otherwise specified	title
E				angles	RECEPTACLE KITS, DUAL ROW, WITH CPA
				linear	WireLock Series Cable Kits
				0°±2'	dwg no
				mm	sheet 2 of 4
				scale 1:1	size
		dr	DAISY WU	7/15/2022	10159549
		engr	NICK ZHANG	7/15/2022	A4
		chr	ZK HU	7/15/2022	type
		appd	TIM YAO	7/15/2022	Product Customer Drawing
sheet index	revision sheet	E	1~4		

PART NUMBER (FROM 14Pos. TO 16Pos.)

10159549-114XXLF ~ 10159549-116XXLF

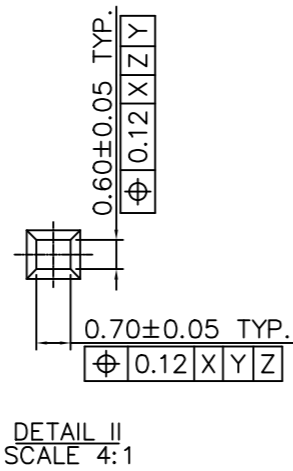
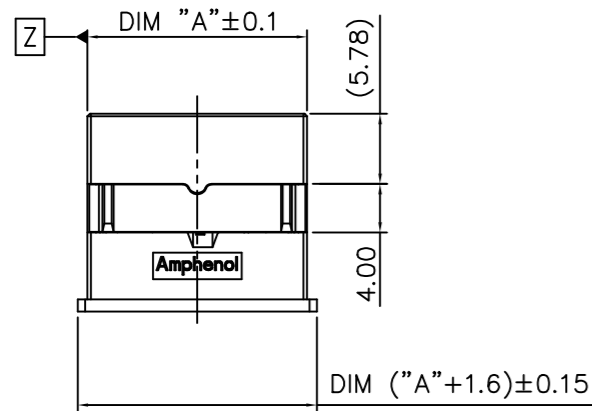
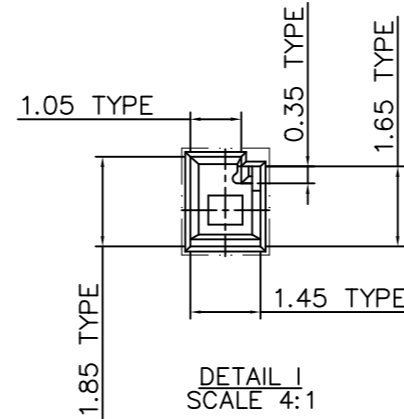
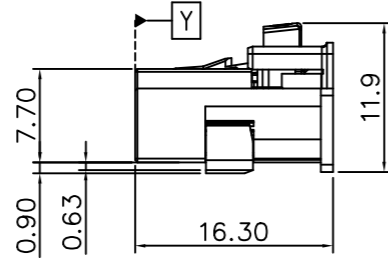
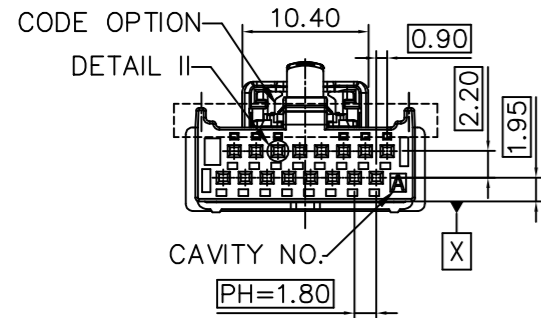

NOTES:

- 1 - MATERIAL: THERMOPLASTIC UL94V-0
COLOR: FOUR COLORS, DETAIL SEE TABLE
- 2 - PACKAGING SPEC: GS-14-2668
- 3 - PART NUMBER CODE: 10159549-1 XX X X LF

NUMBER OF POSITIONS
14 - 14 PINS
2
16 - 16 PINS

RoHS COMPATIBLE
FOR CUSTOMER CODE

CODE OPTION + COLOR
A - A CODE
B - B CODE
C - C CODE
D - D CODE

PACKAGING
K - TRAY PACKAGE
T - PE BAG PACKAGE

POS.	PART NO.	DIM "A"
14	10159549-114XALF	16.30
	10159549-114XBLF	
	10159549-114XCFLF	
	10159549-114XDLF	
16	10159549-116XALF	18.10
	10159549-116XBLF	
	10159549-116XCFLF	
	10159549-116XDLF	

REMARK,
THIS SHEET SHOWS 14Pos.
TO 16Pos.

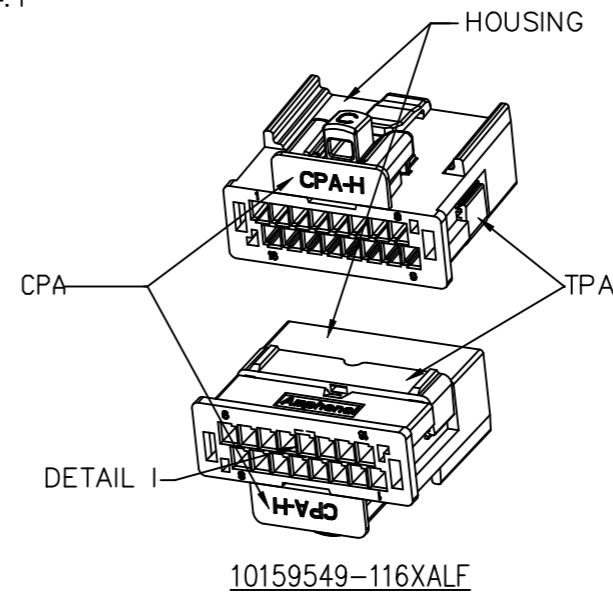

<p>A CODE / COLOR: BLACK</p>	<p>B CODE / COLOR: GREEN; COLOR CODE: RAL6002</p>
<p>C CODE / COLOR: WHITE; COLOR CODE: RAL9001</p>	<p>D CODE / COLOR: BORDEAUX; COLOR CODE: RAL4004</p>
<p>REMARK, THIS SHEET SHOWS 14Pos. TO 18Pos.</p>	

mat'l. code	surface ISO 1302	tolerance ISO 406/ISO 1101	projection	product family HPL649
ltr	ecn no	dr	date	title
E				RECEPTACLE KITS, DUAL ROW, WITH CPA WireLock® Series Cable Kits
				dwg no 10159549
				sheet 3 of 4
				size A4
				type Product Customer Drawing
sheet index	revision sheet	E	1~4	

PART NUMBER (FROM 10Pos. TO 12Pos.)
10159549-110XXLF ~ 10159549-112XXLF

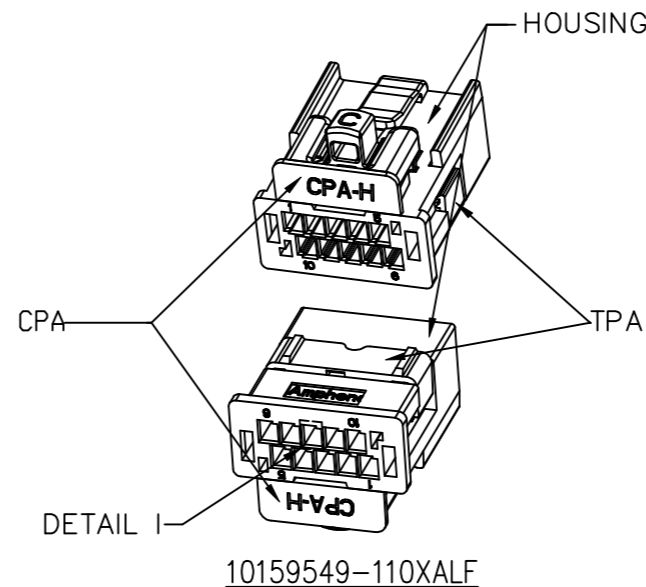
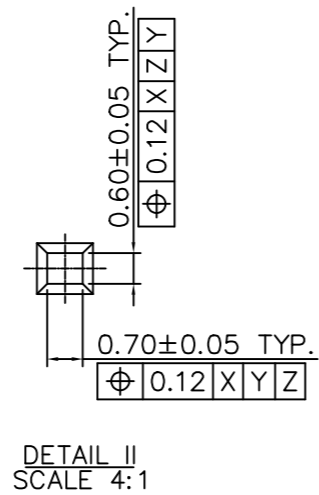
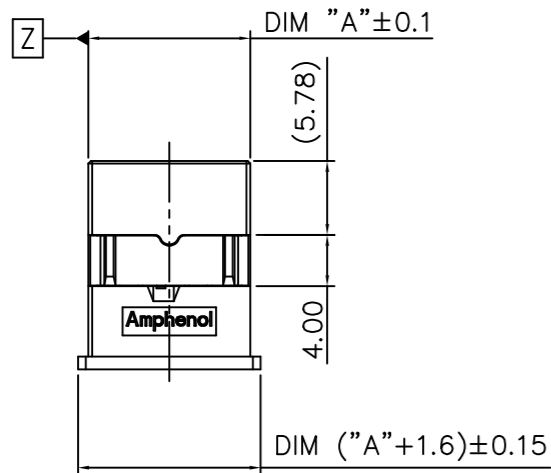
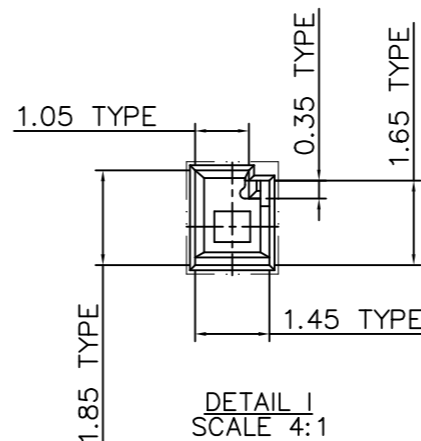
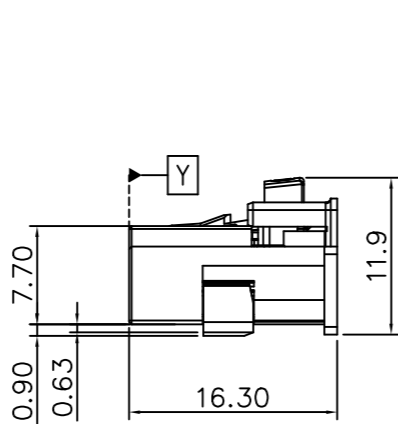
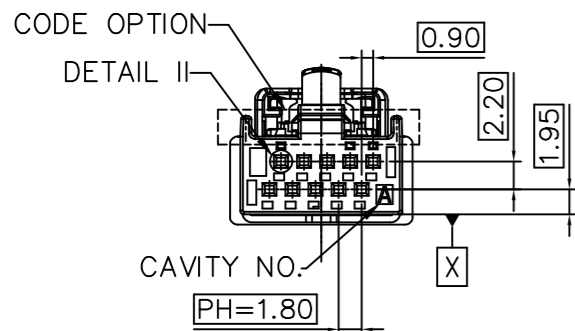

POS.	A CODE / COLOR: BLACK
10	
12	
REMARK, THIS SHEET SHOWS 10Pos. TO 12Pos. NO B/C/D CODE TO PROVIDE.	

POS.	PART NO.	DIM "A"	POS.	PART NO.	DIM "A"
10	10159549-110XALF	12.70	12	10159549-112XALF	14.50
REMARK, THIS SHEET SHOWS 10Pos. TO 12Pos.					

NOTES:

- 1 - MATERIAL: THERMOPLASTIC UL94V-0
COLOR: FOUR COLORS, DETAIL SEE TABLE
 - 2 - PACKAGING SPEC: GS-14-2668
 - 3 - PART NUMBER CODE: 10159549-1 XX X X LF
- RoHS COMPATIBLE FOR CUSTOMER CODE
- CODE OPTION + COLOR
A - A CODE
(NO B/C/D CODE TO PROVIDE.)
- PACKAGING
K - TRAY PACKAGE
T - PE BAG PACKAGE
- NUMBER OF POSITIONS
10 - 10 PINS
2
12 - 12 PINS

mat'l. code		surface ISO 1302	tolerance ISO 406/ISO 1101	projection	product family HPL649
ltr	ecn no	dr	date	tolerances unless otherwise specified	title
E				angles .0±.3 linear .00±.15 0°±2' .000±.010	RECEPTACLE KITS, DUAL ROW, WITH CPA WireLock® Series Cable Kits
				scale 1:1	dwg no 10159549 sheet 4 of 4 size A4
				dr DAISY WU 7/15/2022	Amphenol FCI type Product Customer Drawing
				engr NICK ZHANG 7/15/2022	
				chr ZK HU 7/15/2022	
				appd TIM YAO 7/15/2022	
sheet index	revision sheet	E	1~4		