

THIS DRAWING IS UNPUBLISHED. RELEASED FOR PUBLICATION 20
 © COPYRIGHT 20 BY - ALL RIGHTS RESERVED.

LOC	DIST	REVISIONS					
		P	LTR	DESCRIPTION	DATE	DWN	APVD
-	-	B		ECR-15-013292	24SEP2015	DL	CW
		B1		ECR-15-017530	02DEC2015	GY	CW
		B2		ECR-16-015492	12NOV2016	QY	CW
		C		ECR-21-105750	01JUL2021	BS	CW

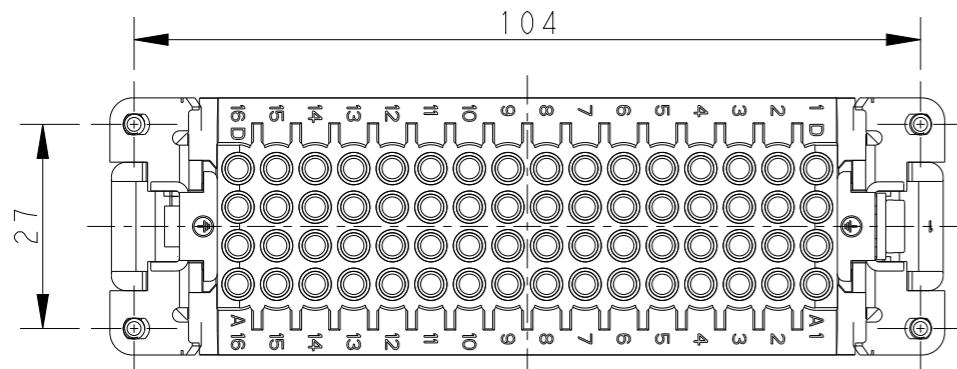

4X M3 SCREW RECOMMENDED
 TIGHTENING TORQUE 0.5Nm
 4X M3螺丝, 推荐锁紧力矩0.5Nm

M4 SCREW RECOMMENDED
 TIGHTENING TORQUE 1.2Nm
 M4 螺丝, 推荐锁紧力矩1.2Nm

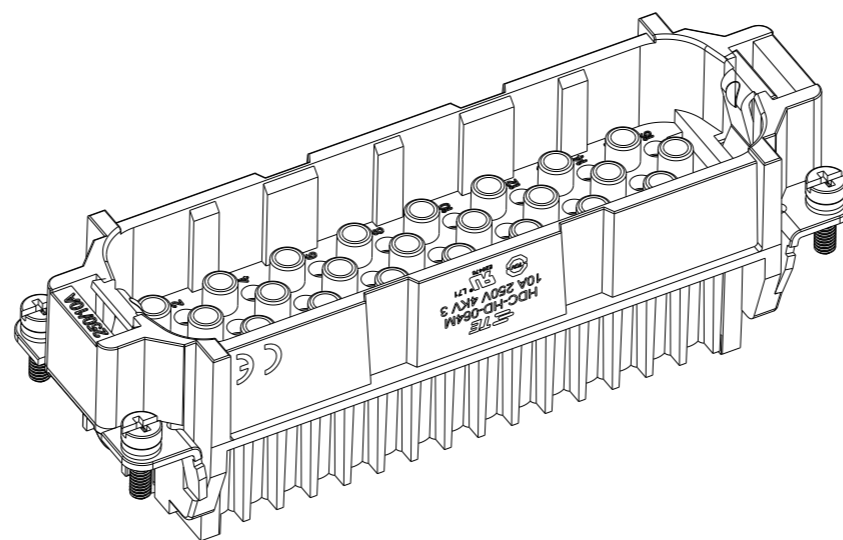
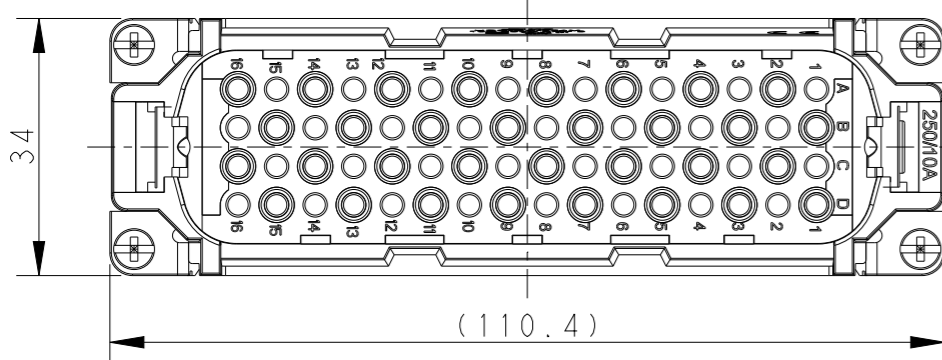
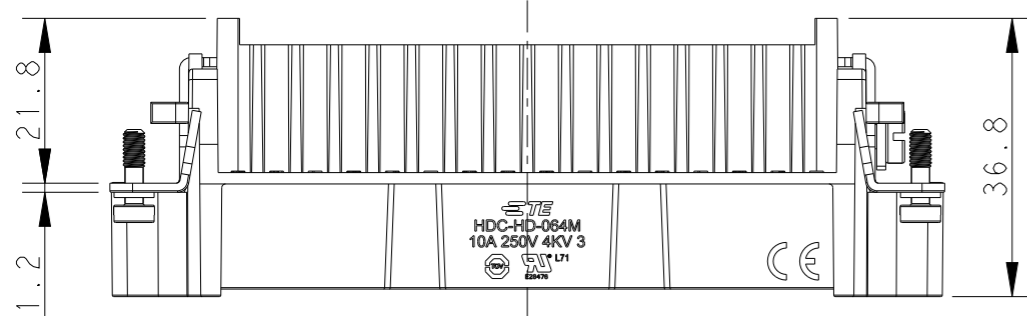

NOTES:
 1. TECHNICAL CHARACTERISTICS:
 INSULATION MATERIAL: PC
 RATED VOLTAGE: 250 V
 RATED CURRENT: 10 A
 INSULATION RESISTANCE: >=400MΩ
 RATED IMPULSE VOLTAGE: 4 KV
 POLLUTION DEGREE: 3
 FLAMMABILITY: UL94V-0
 MATING CYCLES: 500 CYCLES
 WIRE RANGE: 0.14-2.5 mm² (26-14 AWG)
 CONTACT TYPE: CRIMP CONTACT
 2. CONTACT NEED TO BE ORDERED SEPARATELY.
 (ORDER No. REFER TO DRAWING:T20200X10XX000)

注释:
 1. 技术参数:
 绝缘材料: PC
 额定电压: 250V
 额定电流: 10A
 绝缘电阻: >=400MΩ
 额定脉冲电压: 4 KV
 污染等级: 3
 阻燃等级: UL94V-0
 插拔次数: 500次
 接线范围: 0.14-2.5 mm² (26-14 AWG)
 接线类型: 冷压接
 2. 端子需要单独订购.
 (订货号参考图面: T20200X10XX000)

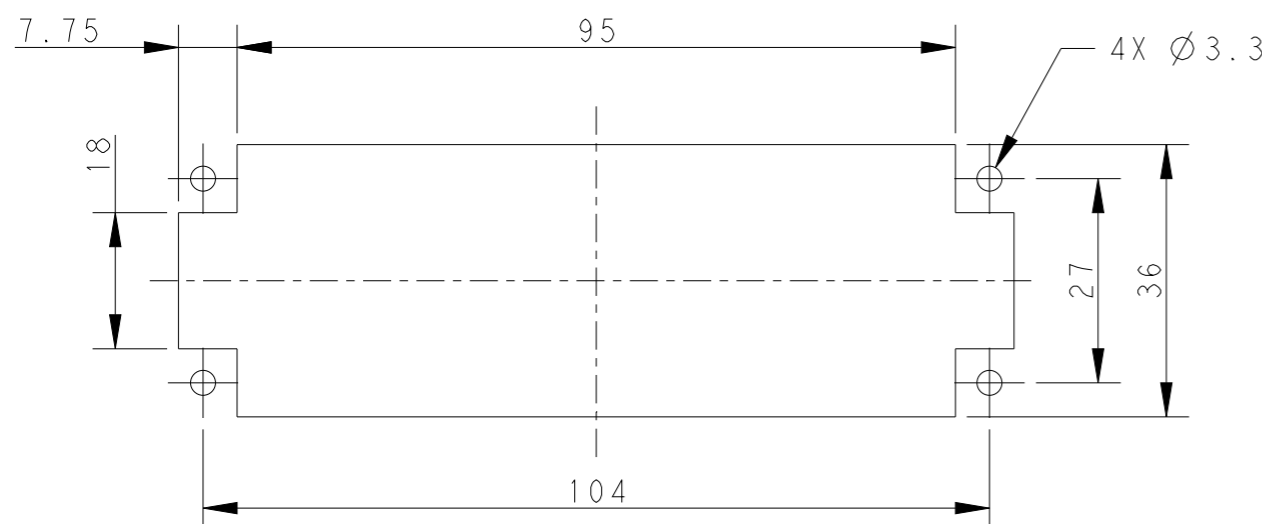

PANEL CUT FOR INSERTS FOR USE
 WITHOUT HOODS/ HOUSINGS
 不用防护外壳时芯件的安装开孔图

TYPE-1, T2020642101-000, TE LOGO
 类型-1, T2020642101-000, TE LOGO
 TYPE-2, T2020642101-001, STAINLESS STEEL SCREW, TE LOGO
 类型-2, T2020642101-001, 不锈钢螺丝, TE LOGO

THIS DRAWING IS A CONTROLLED DOCUMENT.		DWN 300CT2014 David Wang	 TE Connectivity	
DIMENSIONS: mm		CHK 300CT2014 Chris Wang		
TOLERANCES UNLESS OTHERWISE SPECIFIED:		APVD 300CT2014 Xiang Xu	NAME HD-064-M	
0 PLC ±- 1 PLC ±- 2 PLC ±- 3 PLC ±- 4 PLC ±- ANGLES ±-		PRODUCT SPEC 108-137042	SIZE	
MATERIAL -		APPLICATION SPEC 114-137042	CAGE CODE	DRAWING NO
FINISH -		WEIGHT -	A300779	©-T2020642101000
		Customer Drawing	RESTRICTED TO -	
		SCALE 1:1	SHEET 1 OF 2	REV C

4

3

2

1

THIS DRAWING IS UNPUBLISHED.

RELEASED FOR PUBLICATION

20

© COPYRIGHT 20 BY -

ALL RIGHTS RESERVED.

LOC	DIST	REVISIONS					
		P	LTR	DESCRIPTION	DATE	DWN	APVD
-	-	-	-	SEE SHEET 1	-	-	-

NOTE:
SEE SHEET 1
注释:
见页 1

TYPE-3, T2020642101-002, STAINLESS STEEL SCREW, NO LOGO
类型-3, T2020642101-002, 不锈钢螺丝, 无LOGO

T2020642101-002	HD-064-M	HD-064 MALE INSERT, STAINLESS STEEL SCREW, NO LOGO HD-064 公插, 不锈钢螺丝, 无LOGO	TYPE-3 类型-3
T2020642101-001	HD-064-M	HD-064 MALE INSERT, STAINLESS STEEL SCREW HD-064 公插, 不锈钢螺丝	TYPE-2 类型-2
T2020642101-000	HD-064-M	HD-064 MALE INSERT HD-064 公插	TYPE-1 类型-1
PART NUMBER 料号		PART DESCRIPTION 描述	TYPE 类型

ALL DIMENSIONS ARE SAME AS TYPE 1,
EXCEPT THOSE DEFINED IN THIS TYPE.
除了在本类型中定义的尺寸外, 其它尺寸同类型 1

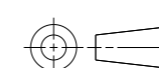
THIS DRAWING IS A CONTROLLED DOCUMENT.		DWN David Wang 30OCT2014	 TE Connectivity		
DIMENSIONS: mm		CHK Chris Wang 30OCT2014			
TOLERANCES UNLESS OTHERWISE SPECIFIED:		APVD Xiang Xu 30OCT2014	NAME HD-064-M		
 0 PLC ±- 1 PLC ±- 2 PLC ±- 3 PLC ±- 4 PLC ±- ANGLES ±-		PRODUCT SPEC 108-137042	RESTRICTED TO		
MATERIAL		APPLICATION SPEC 114-137042	SIZE A3	CAGE CODE 00779	DRAWING NO T2020642101000
FINISH		WEIGHT	SCALE 1:1		
		Customer Drawing	SHEET 2 OF 2		
			REV C		

1470-19 (3/11)