

SECTION Z-Z

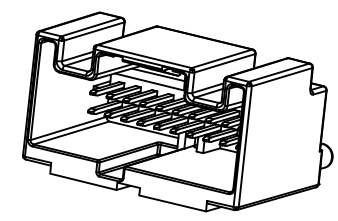

DATECODE, SEE NOTE 6

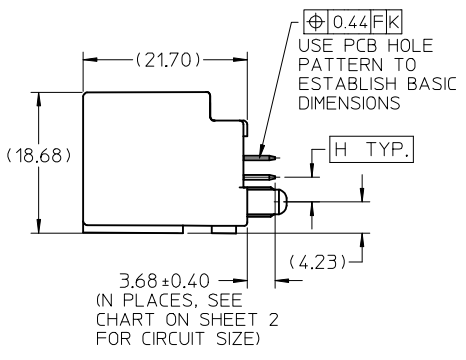
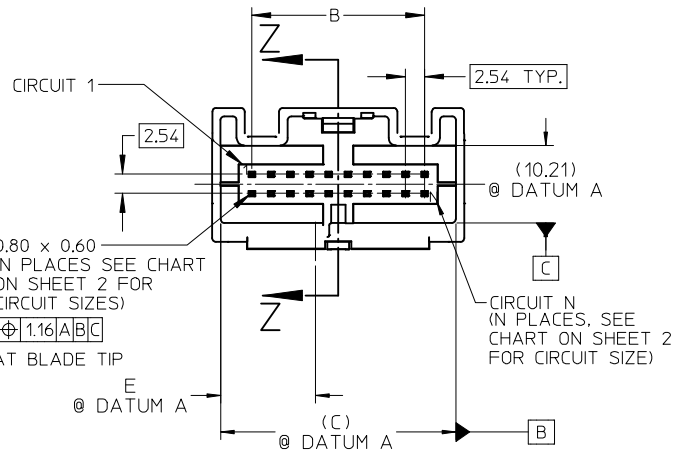

20 CIRCUIT VERTICAL HEADER ASSEMBLY SHOWN

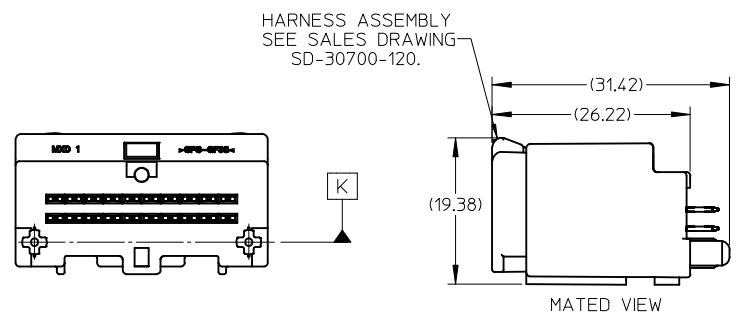

- NOTES:
- MATERIAL: HOUSING: SPS, GLASS FILLED, COLOR: SEE CHART. TERMINAL: COPPER ALLOY C26000.
 - FINISHES: TERMINAL: 150-250µm TIN (Sn) OVERALL; 125µm MIN NICKEL (Ni) UNDERPLATE OVERALL.
 - PRODUCT SPECIFICATION: PS-30700-0001
 - PACKAGING SPECIFICATION: TUBE: PK-30907-227, TRAY: PK-30907-260
 - MATES WITH: SERIES 30700, SEE SALES DRAWING SD-30700-120.
 - DATECODE DESCRIPTION:
 - 1ST DIGIT: MACHINE ID#
 - 2ND THROUGH 4TH DIGIT: DAY # OF THE CALENDAR YEAR (EXAMPLE: FEB. 3RD = "034")
 - 5TH DIGIT: LAST DIGIT OF THE CALENDAR YEAR (EXAMPLE: 1999 = "9")
 - 6TH THROUGH 7TH DIGIT: HOUR OF THE DAY.
 - RECOMMENDED OPTIONAL SCREW: M2 x 0.89, 6mm IN LENGTH, PAN COLLAR HEAD, 6 LOBE, TORQUE: 7 NEWTON CENTIMETERS

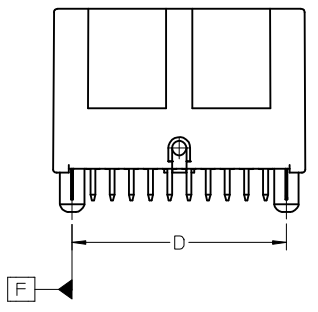

SEE ECN# UAU2001-0258 EC NO: UAU2017-0902 DRWN: JFISCHER02017/04/04 CHKD: APPR: RBAUMAN 2017/04/13	QUALITY SYMBOLS	GENERAL TOLERANCES (UNLESS SPECIFIED)		SCALE 2:1	DESIGN UNITS METRIC	THIRD ANGLE PROJECTION	REVISE ON CAD ONLY
	▼ -0 ∇ C -0	4 PLACES	± ---	± ---	DIMENSION STYLE MM ONLY		TITLE 6-20 CIRCUIT VERTICAL HEADER ASSEMBLY MOLEX INCORPORATED MATERIAL NO. ENTER-PART SD-30700-420 DOCUMENT NO. SD-30700-420 SHEET NO. 1 OF 3
		3 PLACES	± ---	± ---	DRAWN BY RCARLSON	DATE 01/03/20	
		2 PLACES	± 0.13	± ---	CHECKED BY CKRISHNA	DATE 01/03/27	
1 PLACE	± 0.25	± ---	APPROVED BY LGIEIB	DATE 01/03/28			
		ANGULAR ± 1 °		DRAFT WHERE APPLICABLE		THIS DRAWING CONTAINS INFORMATION THAT IS PROPRIETARY TO MOLEX INCORPORATED AND SHOULD NOT BE USED WITHOUT WRITTEN PERMISSION	
		MUST REMAIN WITHIN DIMENSIONS					

BELOW VIEWS APPLY TO
30700-4067/8/9 PART NUMBERS

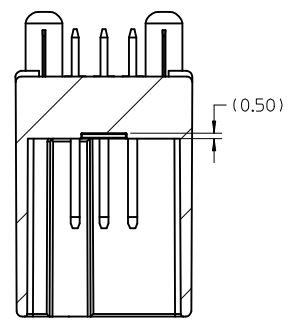

SECTION Y-Y
SCALE 3:1

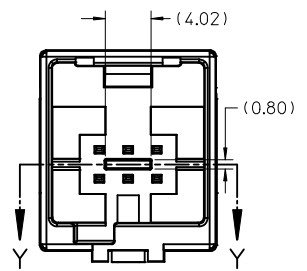

EC NO: UAU2017-0902 DRWN: JFISCHER02017/04/04 CHKD: APPR: RBAUMAN 2017/04/13	QUALITY SYMBOLS ▽ - 0 ∇ - 0	GENERAL TOLERANCES (UNLESS SPECIFIED)		SCALE 1:1	DESIGN UNITS METRIC	THIRD ANGLE PROJECTION	REVISE ON CAD ONLY		
		4 PLACES ± --- ± ---	3 PLACES ± --- ± ---	DIMENSION STYLE MM ONLY		TITLE 6-20 CIRCUIT VERTICAL HEADER ASSEMBLY			
		2 PLACES ± 0.13 ± ---	1 PLACE ± 0.25 ± ---	DRAWN BY R CARLSON	DATE 01/03/20	MOLEX INCORPORATED			
		ANGULAR ± 1 °		CHECKED BY CKRISHNA	DATE 01/03/27	APPROVED BY LGIEB	DATE 01/03/28	MATERIAL NO. ENTER-PART	DOCUMENT NO. SD-30700-420
E4	REV	DRAFT WHERE APPLICABLE MUST REMAIN WITHIN DIMENSIONS		THIS DRAWING CONTAINS INFORMATION THAT IS PROPRIETARY TO MOLEX INCORPORATED AND SHOULD NOT BE USED WITHOUT WRITTEN PERMISSION					

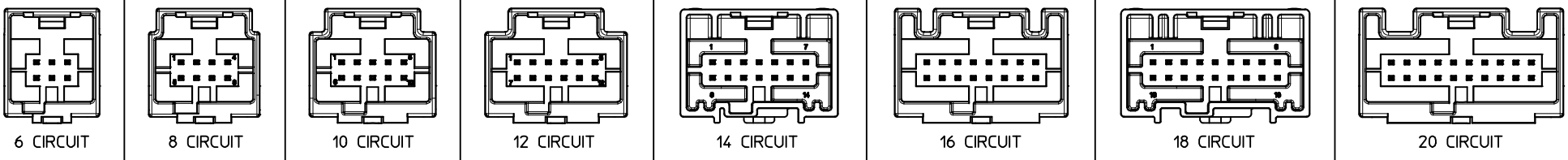

PACKAGING		POLARIZATION OPTIONS & CIRCUIT SIZE		PRODUCT DIMENSIONS								HOUSING COLOR	STATUS
ASSEMBLY P/N TRAY PACKED	ASSEMBLY P/N TUBE PACKED	VERTICAL HEADER ASSEMBLY (POLARIZATION OPTIONS)	CIRCUIT SIZE	(A)	B	(C)	D	E	H				
30700-4200	30700-4204	POLARIZATION OPTION #1	20	33.38	22.86	31.14	28.38	12.57	3.20	GRAY	RELEASED		
30700-4201	30700-4205	POLARIZATION OPTION #2	20	33.38	22.86	31.14	28.38	15.57		BLACK	RELEASED		
30700-4202	30700-4206	POLARIZATION OPTION #3	20	33.38	22.86	31.14	28.38	18.57		NATURAL (CREAM)	RELEASED		
30700-4187	---	POLARIZATION OPTION #1	18	30.84	20.32	28.60	25.84	11.31	3.25	GRAY	RELEASED		
30700-4188	---	POLARIZATION OPTION #2	18	30.84	20.32	28.60	25.84	14.31		BLACK	RELEASED		
30700-4189	---	POLARIZATION OPTION #3	18	30.84	20.32	28.60	25.84	17.31		NATURAL (CREAM)	RELEASED		
30700-4160	30700-4164	POLARIZATION OPTION #1	16	28.30	17.78	26.06	23.30	10.04	3.20	GRAY	RELEASED		
30700-4161	30700-4165	POLARIZATION OPTION #2	16	28.30	17.78	26.06	23.30	13.04		BLACK	RELEASED		
30700-4162	30700-4166	POLARIZATION OPTION #3	16	28.30	17.78	26.06	23.30	16.04		NATURAL (CREAM)	RELEASED		
30700-4147	---	POLARIZATION OPTION #1	14	25.76	15.24	23.52	20.76	8.77	3.25	GRAY	RELEASED		
30700-4148	---	POLARIZATION OPTION #2	14	25.76	15.24	23.52	20.76	11.77		BLACK	RELEASED		
30700-4149	---	POLARIZATION OPTION #3	14	25.76	15.24	23.52	20.76	14.77		NATURAL (CREAM)	RELEASED		
30700-4120	30700-4124	POLARIZATION OPTION #1	12	23.22	12.70	20.98	18.22	7.50	3.20	GRAY	RELEASED		
30700-4121	30700-4125	POLARIZATION OPTION #2	12	23.22	12.70	20.98	18.22	10.50		BLACK	RELEASED		
30700-4122	30700-4126	POLARIZATION OPTION #3	12	23.22	12.70	20.98	18.22	13.50		NATURAL (CREAM)	RELEASED		
30700-4100	30700-4104	POLARIZATION OPTION #1	10	20.68	10.16	18.44	15.68	6.23	3.20	GRAY	RELEASED		
30700-4101	30700-4105	POLARIZATION OPTION #2	10	20.68	10.16	18.44	15.68	9.23		BLACK	RELEASED		
30700-4102	30700-4106	POLARIZATION OPTION #3	10	20.68	10.16	18.44	15.68	12.23		NATURAL (CREAM)	RELEASED		
30700-4080	30700-4084	POLARIZATION OPTION #1	8	18.14	7.62	15.90	13.14	4.96	3.20	GRAY	RELEASED		
30700-4081	30700-4085	POLARIZATION OPTION #2	8	18.14	7.62	15.90	13.14	7.96		BLACK	RELEASED		
30700-4082	30700-4086	POLARIZATION OPTION #3	8	18.14	7.62	15.90	13.14	10.96		NATURAL (CREAM)	RELEASED		
30700-4060	30700-4064	POLARIZATION OPTION #1	6	15.60	5.08	13.36	10.60	3.69	3.20	GRAY	RELEASED		
30700-4061	30700-4065	POLARIZATION OPTION #2	6	15.60	5.08	13.36	10.60	6.69		BLACK	RELEASED		
30700-4062	30700-4066	POLARIZATION OPTION #3	6	15.60	5.08	13.36	10.60	9.69		NATURAL (CREAM)	RELEASED		

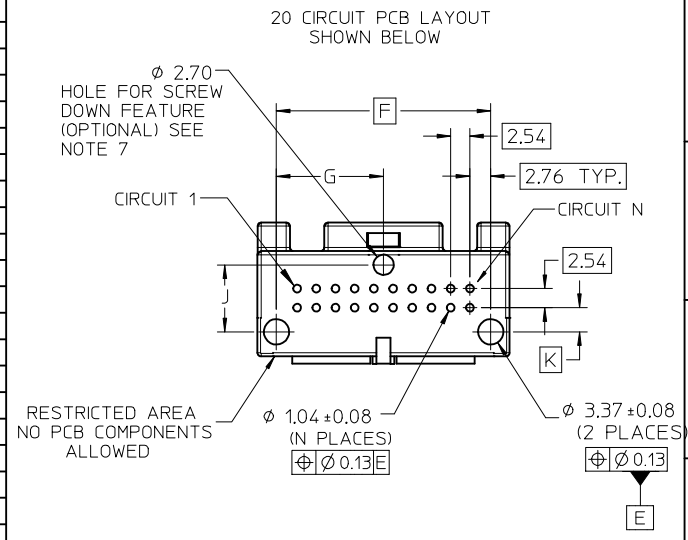

PCB LAYOUT: COMPONENT SIDE
RECOMMENDED PCB THICKNESS: 1.57±0.17

PCB LAYOUT DIMENSIONS				
CIRCUIT SIZE (N)	F	G	J	K
20	28.38	14.19	8.87	3.20
18	25.84	12.92	8.94	3.25
16	23.30	11.65	8.87	3.20
14	20.76	10.38	8.94	3.25
12	18.22	9.11	8.87	3.20
10	15.68	7.84	8.87	3.20
8	13.14	6.57	8.87	3.20
6	10.60	5.30	8.87	3.20

30700-4067/8/9 PART NUMBER DENOTES HDAC WITH MOAT FEATURE											
PACKAGING		POLARIZATION OPTIONS & CIRCUIT SIZE		PRODUCT DIMENSIONS							
ASSEMBLY P/N TRAY PACKED	ASSEMBLY P/N TUBE PACKED	VERTICAL HEADER ASSEMBLY (POLARIZATION OPTIONS)	CIRCUIT SIZE	(A)	B	(C)	D	E	HOUSING COLOR	STATUS	
30700-4067	TBD	POLARIZATION OPTION #1	6	15.60	5.08	13.36	10.60	3.69	GRAY	RELEASED	
30700-4068	TBD	POLARIZATION OPTION #2	6	15.60	5.08	13.36	10.60	6.69	BLACK	RELEASED	
30700-4069	TBD	POLARIZATION OPTION #3	6	15.60	5.08	13.36	10.60	9.69	NATURAL (CREAM)	RELEASED	

SEE ECN# UAU2001-0258 EC NO: UAU2017-0902 DRWN: JFISCHER02017/04/04 CHKD: RBAUJMAN 2017/04/13 APPR: RBAUJMAN 2017/04/13	QUALITY SYMBOLS ▽ - 0 ▽ - 0	GENERAL TOLERANCES (UNLESS SPECIFIED) mm INCH		SCALE 2:1	DESIGN UNITS METRIC	THIRD ANGLE PROJECTION	REVISE ON CAD ONLY	
		4 PLACES ± --- ± ---	3 PLACES ± --- ± ---	DIMENSION STYLE MM ONLY		TITLE		
		2 PLACES ± 0.13 ± ---	1 PLACE ± 0.25 ± ---	DRAWN BY RCARLSON DATE 01/03/20		6-20 CIRCUIT VERTICAL HEADER ASSEMBLY		
		ANGULAR ± 1 °		CHECKED BY CKRISHNA DATE 01/03/27		MOLEX INCORPORATED		
DRAFT WHERE APPLICABLE		APPROVED BY LGIEB DATE 01/03/28		MATERIAL NO. ENTER-PART		DOCUMENT NO. SD-30700-420		
MUST REMAIN WITHIN DIMENSIONS		THIS DRAWING CONTAINS INFORMATION THAT IS PROPRIETARY TO MOLEX INCORPORATED AND SHOULD NOT BE USED WITHOUT WRITTEN PERMISSION						SHEET NO. 3 OF 3