



Dynamic Series | Dynamic 1000 Series

TE Internal #: 1871303-1

Connector Contact, Receptacle, Component-to-Wire, 28 – 22 AWG

Wire Size, .08 – .38 mm² Wire Size, Tin, Reel & Box, Wire & Cable,

Dynamic 1000 Series

[View on TE.com >](#)

Connectors > PCB Connectors > Wire-to-Board Connectors > Wire-to-Board Connector Contacts >

Contact: Component To Wire; 3-5A, 30-18 Wire Size



Contact Type: **Receptacle**

Connector System: **Component-to-Wire**

Wire Size: **.08 – .38 mm²**

Contact Mating Area Plating Material: **Tin**

All Contact: Component To Wire; 3-5A, 30-18 Wire Size (30)

Features

Product Type Features

Connector System	Component-to-Wire
Connector & Contact Terminates To	Wire & Cable

Contact Features

Mating Tab Width	.7 mm[.027 in]
Mating Tab Thickness	.5 mm[.02 in]
Contact Type	Receptacle
Contact Mating Area Plating Material	Tin
Contact Current Rating (Max)	5 A

Dimensions

Wire Size	.08 – .38 mm ²
-----------	---------------------------

Usage Conditions

Operating Temperature Range	-55 – 105 °C[-67 – 221 °F]
-----------------------------	----------------------------



Operation/Application

Circuit Application	Signal
---------------------	--------

Packaging Features

Packaging Method	Reel & Box
------------------	------------

Product Compliance

[For compliance documentation, visit the product page on TE.com>](#)

EU RoHS Directive 2011/65/EU	Compliant
EU ELV Directive 2000/53/EC	Compliant
China RoHS 2 Directive MIIT Order No 32, 2016	No Restricted Materials Above Threshold
EU REACH Regulation (EC) No. 1907/2006	Current ECHA Candidate List: JUNE 2023 (235) Candidate List Declared Against: JUNE 2023 (235) Does not contain REACH SVHC
Halogen Content	Low Halogen - Br, Cl, F, I < 900 ppm per homogenous material. Also BFR/CFR/PVC Free
Solder Process Capability	Not applicable for solder process capability

Product Compliance Disclaimer

This information is provided based on reasonable inquiry of our suppliers and represents our current actual knowledge based on the information they provided. This information is subject to change. The part numbers that TE has identified as EU RoHS compliant have a maximum concentration of 0.1% by weight in homogenous materials for lead, hexavalent chromium, mercury, PBB, PBDE, DBP, BBP, DEHP, DIBP, and 0.01% for cadmium, or qualify for an exemption to these limits as defined in the Annexes of Directive 2011/65/EU (RoHS2). Finished electrical and electronic equipment products will be CE marked as required by Directive 2011/65/EU. Components may not be CE marked. Additionally, the part numbers that TE has identified as EU ELV compliant have a maximum concentration of 0.1% by weight in homogenous materials for lead, hexavalent chromium, and mercury, and 0.01% for cadmium, or qualify for an exemption to these limits as defined in the Annexes of Directive 2000/53/EC (ELV). Regarding the REACH Regulation, the information TE provides on SVHC in articles for this part number is based on the latest European Chemicals Agency (ECHA) 'Guidance on requirements for substances in articles' posted at this URL: <https://echa.europa.eu/guidance-documents/guidance-on-reach>

Compatible Parts

TE Part # 1891526-1
EXTRACTION TOOL FOR DYNAMIC 1000 SERIES

TE Part # 2305570-1
Strip Terminal Cutter-Side Feed-No Crimp

TE Part # 2-2151082-1
OCEAN_2.0_APPLICATOR-S-046F057F

TE Part # 2151082-1
OCEAN_2.0_APPLICATOR-S-046F057F



Also in the Series | **Dynamic 1000 Series**

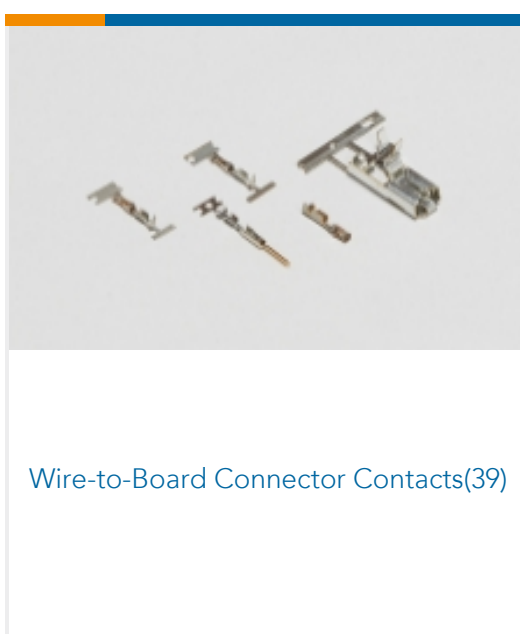
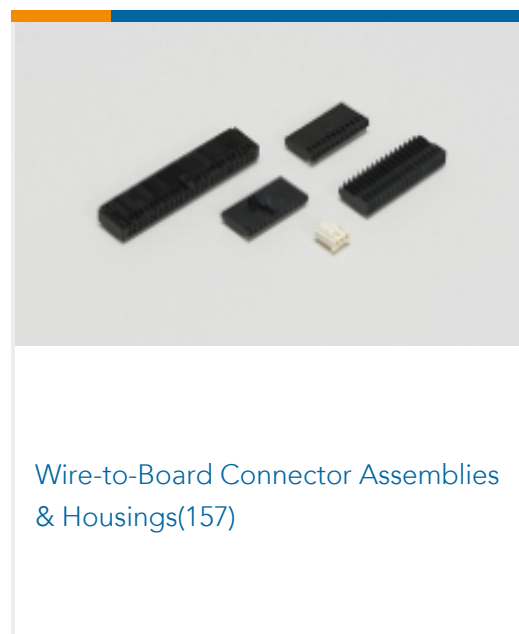
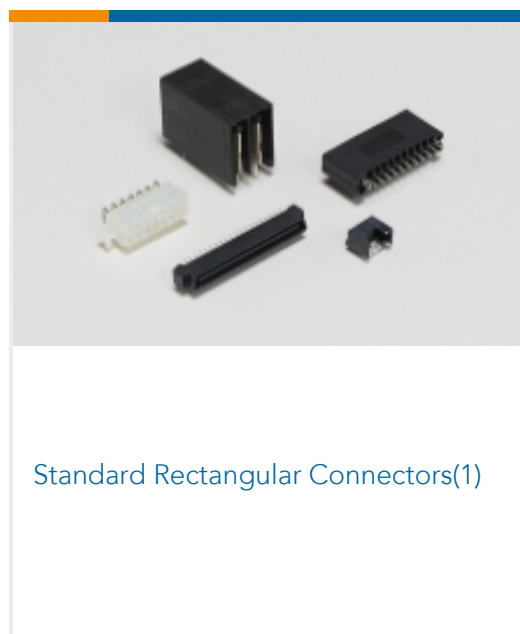
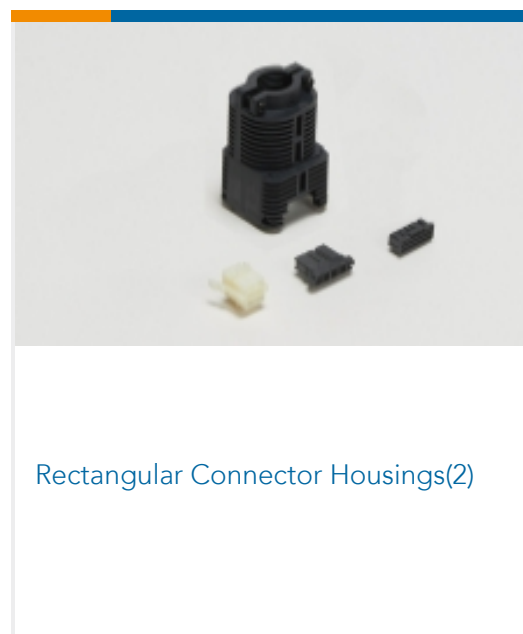
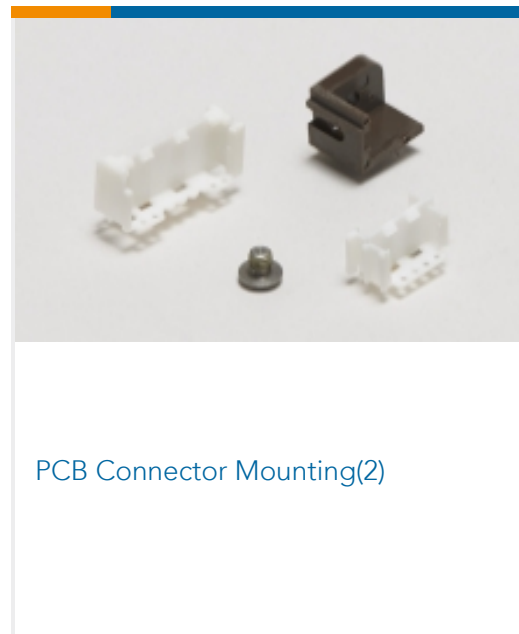
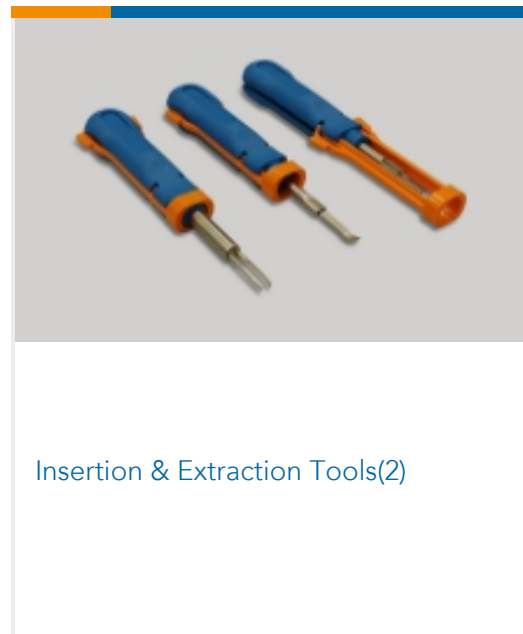
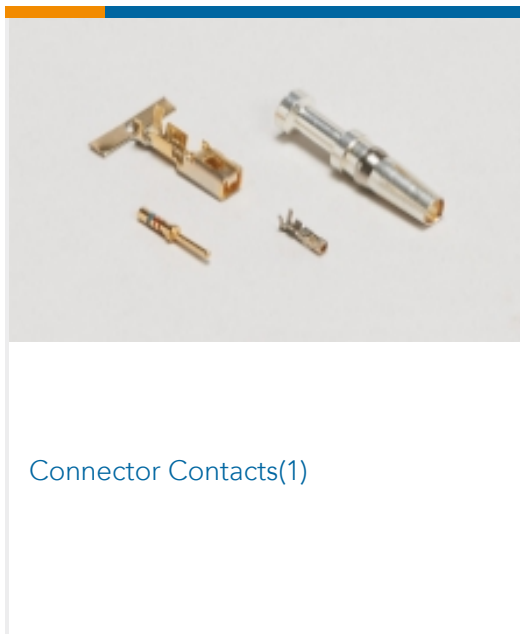

Customers Also Bought



TE Part #1-1903131-3
DYNAMIC 1200D TAB HSG 6P P/M



TE Part #1903112-2
DYNAMIC D1000 TAB CONT AU 0.38 um M REEL



TE Part #1-2333149-5
DYNAMIC 1100D REC HSG 10P X BLACK 33%GF



TE Part #T2111028101-000
HMN-D2-MC



TE Part #1-1747414-2
DYNAMIC 4200S TAB HSG 2P F/H X



TE Part #1-2333149-0
DYNAMIC 1100D REC HSG 20P X BLACK 33% GF

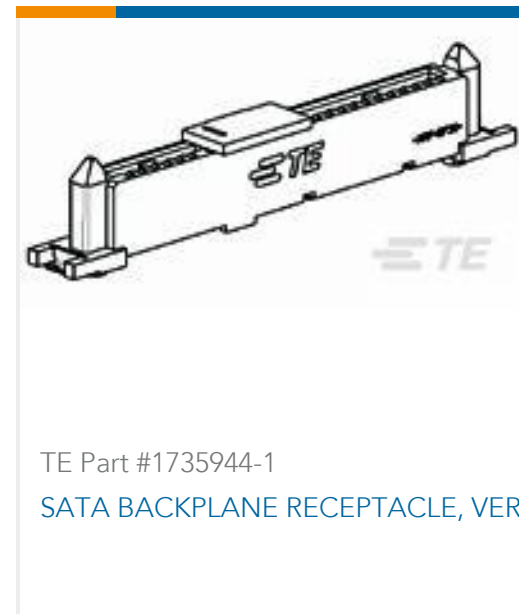

TE Part #1735944-1
SATA BACKPLANE RECEPTACLE, VER

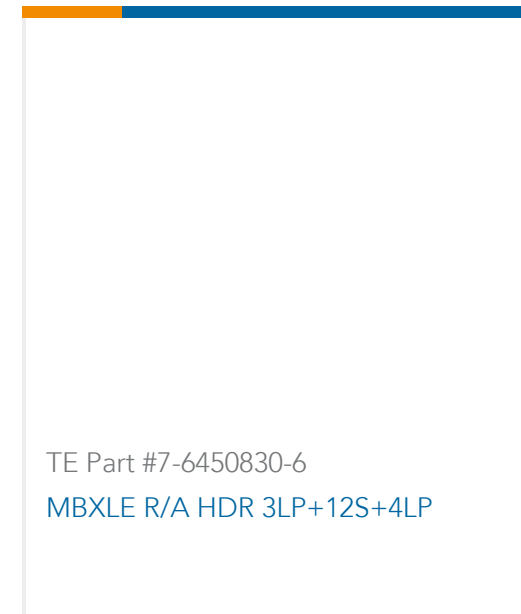

TE Part #7-6450830-6
MBXLE R/A HDR 3LP+12S+4LP

Documents

Product Drawings

[DYNAMIC D1000 REC CONT M PRE TIN REEL](#)

Japanese

CAD Files

Customer View Model

[ENG_CVM_1871303-1_B.3d_igs.zip](#)

English

Customer View Model

[ENG_CVM_1871303-1_B.3d_stp.zip](#)

English

Customer View Model

[ENG_CVM_1871303-1_B.2d_dxf.zip](#)

English

3D PDF

3D

By downloading the CAD file I accept and agree to the [Terms and Conditions](#) of use.

Datasheets & Catalog Pages

[Datasheet - Ev-Charging Dynamic-Wire-To-Board-Connectors](#)

English

[1-1773732-4_DYNAMIC_SERIES_CATALOG_ENGLISH](#)

Japanese

[1-1773732-4_DYNAMIC_SERIES_CATALOG_ENGLISH](#)

English

Product Specifications



Application Specification

English

Product Environmental Compliance

MD_1871303-1_06112018441_dmtec

English

MD_1871303-1_06112018441_dmtec

English

Instruction Sheets

Instruction Sheet (non U.S.)

English

Agency Approvals

TUV Certificate

English