

PKB4000D series Fully Regulated DC-DC Converters
 Input 36-60 V, Output up to 37.5 A / 450 W

28701-BMR 67406 RevG August 2022

© Flex

Key Features

- Industry standard low profile Eighth-brick
58.4 x 22.7 x 13.2 mm (2.29 x 0.89 x 0.52 in)
- High efficiency, typical 96 % at 48 Vin, 12 Vout, half load
- 1500 Vdc baseplate to output isolation
- Pre-bias start up
- Baseplate version
- Meets safety requirements according to IEC/EN/UL 62368-1
- MTBF 8.5 million hours

General Characteristics

- Input under voltage shutdown
- Monotonic start-up
- Remote control
- Output over voltage protection
- Over temperature protection
- Output short-circuit protection
- Highly automated manufacturing ensures quality
- ISO 9001/14001 certified supplier



Safety Approvals



Design for Environment



Meets requirements in high-temperature lead-free soldering processes.

Contents

| | |
|-------------------------------------|----------------------|
| Ordering Information | 2 |
| General Information | 2 |
| Safety Specification | 3 |
| Absolute Maximum Ratings | 4 |
| Electrical Specification | |
| 12 V, 37.5 A / 450 W | PKB4413DPIHS 5 |
| EMC Specifications | 9 |
| Operating Information | 10 |
| Thermal Consideration | 12 |
| Connections | 13 |
| Mechanical Information | 14 |
| Soldering Information | 16 |
| Delivery Information | 17 |
| Product Qualification Specification | 19 |

PKB4000D series Fully Regulated DC-DC Converters Input 36-60 V, Output up to 37.5 A / 450 W

28701-BMR 67406 RevG August 2022

© Flex

Ordering Information

| Product program | Output |
|-----------------|----------------------|
| PKB4413DPIHS | 12 V, 37.5 A / 450 W |

Product number and Packaging

| PKB 4413D n ₁ n ₂ n ₃ n ₄ n ₅ | | | | | |
|--------------------------------------------------------------------------------------|----------------|----------------|----------------|----------------|----------------|
| Options | n ₁ | n ₂ | n ₃ | n ₄ | n ₅ |
| Mounting | o | | | | |
| Remote Control logic | | o | | | |
| Baseplate | | | o | | |
| Lead length | | | | o | |
| Delivery package information | | | | | o |

| Options | Description |
|----------------|-----------------------------------------------------|
| n ₁ | SI Surface mount PI Through hole |
| n ₂ | Negative * P Positive |
| n ₃ | HS Baseplate* |
| n ₄ | 5.30 mm * LA 3.69 mm LB 4.57 mm LC 2.79 mm |
| n ₅ | /B Tray |

Note: A through hole pin mounted with baseplate, positive logic, 4.57mm pin length 12V product with tray package, the ordering information is PKB4413DPIP HSLB/B.

No baseplate option available for SI option product.

General Information

Reliability

The failure rate (λ) and mean time between failures (MTBF = $1/\lambda$) is calculated at max output power and an operating ambient temperature (T_A) of +40°C. Flex Power Modules uses Telcordia SR-332 Issue 3 Method 1 to calculate the mean steady-state failure rate and standard deviation (σ).

Telcordia SR-332 Issue 3 also provides techniques to estimate the upper confidence levels of failure rates based on the mean and standard deviation.

| Mean steady-state failure rate, | Std. deviation, σ |
|---------------------------------|--------------------------|
| 118 nFailures/h | 9.1 nFailures/h |

MTBF (mean value) for the PKB4413D series = 8.50 Mh.
MTBF at 90% confidence level = 7.73 Mh

Compatibility with RoHS requirements

The products are compatible with the relevant clauses and

requirements of the RoHS directive 2011/65/EU and have a maximum concentration value of 0.1% by weight in homogeneous materials for lead, mercury, hexavalent chromium, PBB and PBDE and of 0.01% by weight in homogeneous materials for cadmium.

Exemptions in the RoHS directive utilized in Flex Power Modules products are found in the Statement of Compliance document.

Flex Power Modules fulfills and will continuously fulfill all its obligations under regulation (EC) No 1907/2006 concerning the registration, evaluation, authorization and restriction of chemicals (REACH) as they enter into force and is through product materials declarations preparing for the obligations to communicate information on substances in the products.

Quality Statement

The products are designed and manufactured in an industrial environment where quality systems and methods like ISO 9000, Six Sigma, and SPC are intensively in use to boost the continuous improvements strategy. Infant mortality or early failures in the products are screened out and they are subjected to an ATE-based final test. Conservative design rules, design reviews and product qualifications, plus the high competence of an engaged work force, contribute to the high quality of the products.

Warranty

Warranty period and conditions are defined in Flex Power Modules General Terms and Conditions of Sale.

Limitation of Liability

Flex Power Modules does not make any other warranties, expressed or implied including any warranty of merchantability or fitness for a particular purpose (including, but not limited to, use in life support applications, where malfunctions of product can cause injury to a person's health or life).

© Flex 2022

The information and specifications in this technical specification is believed to be correct at the time of publication. However, no liability is accepted for inaccuracies, printing errors or for any consequences thereof. Flex AB reserves the right to change the contents of this technical specification at any time without prior notice.

| | |
|-------------------------------------------------------------------------------------------------------|----------------------------------|
| PKB4000D series Fully Regulated DC-DC Converters Input 36-60 V, Output up to 37.5 A / 450 W | 28701-BMR 67406 RevG August 2022 |
| | © Flex |

Safety Specification

General information

Flex Power DC/DC converters and DC/DC regulators are designed in accordance with the safety standards IEC 62368-1, EN 62368-1 and UL 62368-1 *Audio/video, information and communication technology equipment - Part 1: Safety requirements*

IEC/EN/UL 62368-1 contains requirements to prevent injury or damage due to the following hazards:

- Electrical shock
- Electrically-caused fire
- Injury caused by hazardous substances
- Mechanically-caused injury
- Skin burn
- Radiation-caused injury

On-board DC/DC converters, Power interface modules and DC/DC regulators are defined as component power supplies. As components they cannot fully comply with the provisions of any safety requirements without "conditions of acceptability". Clearance between conductors and between conductive parts of the component power supply and conductors on the board in the final product must meet the applicable safety requirements. Certain conditions of acceptability apply for component power supplies with limited stand-off (see Mechanical Information for further information). It is the responsibility of the installer to ensure that the final product housing these components complies with the requirements of all applicable safety standards and regulations for the final product.

Component power supplies for general use shall comply with the requirements in IEC/EN/UL 62368-1. Product related standards, e.g. IEEE 802.3af *Power over Ethernet*, and ETS-300132-2 *Power interface at the input to telecom equipment, operated by direct current (dc)* are based on IEC/EN/UL 60950-1 with regards to safety.

Flex Power DC/DC converters, Power interface modules and DC/DC regulators are UL 62368-1 recognized and certified in accordance with EN 62368-1. The flammability rating for all construction parts of the products meet requirements for V-0 class material according to IEC 60695-11-10, *Fire hazard testing, test flames – 50 W* horizontal and vertical flame test methods.

Isolated DC/DC converters & Power interface modules

The product may provide basic or functional insulation between input and output according to IEC/EN/UL 62368-1 (see Safety Certificate), different conditions shall be met if the output of a basic or a functional insulated product shall be considered as ES1 energy source.

For basic insulated products (see Safety Certificate) the output is considered as ES1 energy source if one of the

following conditions is met:

- The input source provides supplementary or double or reinforced insulation from the AC mains according to IEC/EN/UL 62368-1.
- The input source provides functional or basic insulation from the AC mains and the product's output is reliably connected to protective earth according to IEC/EN/UL 62368-1.

For functional insulated products (see Safety Certificate) the output is considered as ES1 energy source if one of the following conditions is met:

- The input source provides double or reinforced insulation from the AC mains according to IEC/EN/UL 62368-1.
- The input source provides basic or supplementary insulation from the AC mains and the product's output is reliably connected to protective earth according to IEC/EN/UL 62368-1.
- The input source is reliably connected to protective earth and provides basic or supplementary insulation according to IEC/EN/UL 62368-1 and the maximum input source voltage is 60 Vdc.

Galvanic isolation between input and output is verified in an electric strength test and the isolation voltage (V_{iso}) meets the voltage strength requirement for basic insulation according to IEC/EN/UL 62368-1.

It is recommended to use a slow blow fuse at the input of each DC/DC converter. If an input filter is used in the circuit the fuse should be placed in front of the input filter. In the rare event of a component problem that imposes a short circuit on the input source, this fuse will provide the following functions:

- Isolate the fault from the input power source so as not to affect the operation of other parts of the system
- Protect the distribution wiring from excessive current and power loss thus preventing hazardous overheating

PKB4000D series Fully Regulated DC-DC Converters
 Input 36-60 V, Output up to 37.5 A / 450 W

28701-BMR 67406 RevG August 2022
 © Flex

Absolute Maximum Ratings

| Characteristics | | min | typ | max | Unit |
|-----------------|-----------------------------------------------------------------------------------|-----------------------|------|------|------|
| T_{P1} | Operating Temperature (see Thermal Consideration section) | -40 | | +125 | °C |
| T_S | Storage temperature | -55 | | +125 | °C |
| V_I | Input voltage | -0.5 | | +72 | V |
| C_{out} | Output capacitance | 100 | | | µF |
| V_{iso} | Isolation voltage (input to output test voltage) | | | 1500 | Vdc |
| V_{iso} | Isolation voltage (input to baseplate qualification test voltage) | | | 1500 | Vdc |
| V_{iso} | Isolation voltage (baseplate to output qualification test voltage) | | | 750 | Vdc |
| V_{tr} | Input voltage transient according to ETSI EN 300 132-2 and Telcordia GR-1089-CORE | | | 80 | V |
| V_{RC} | Remote Control pin voltage (see Operating Information section) | Positive logic option | | 6 | V |
| | | Negative logic option | -0.5 | 6 | V |

Stresses above those listed under Absolute Maximum Ratings may cause permanent damage to the device. This is a stress rating only; functional operation of the device at these or any other conditions above those indicated in the Electrical Specification section of this specification is not implied. Exposure to absolute maximum rating conditions for extended periods may affect device reliability.

Fundamental Circuit Diagram

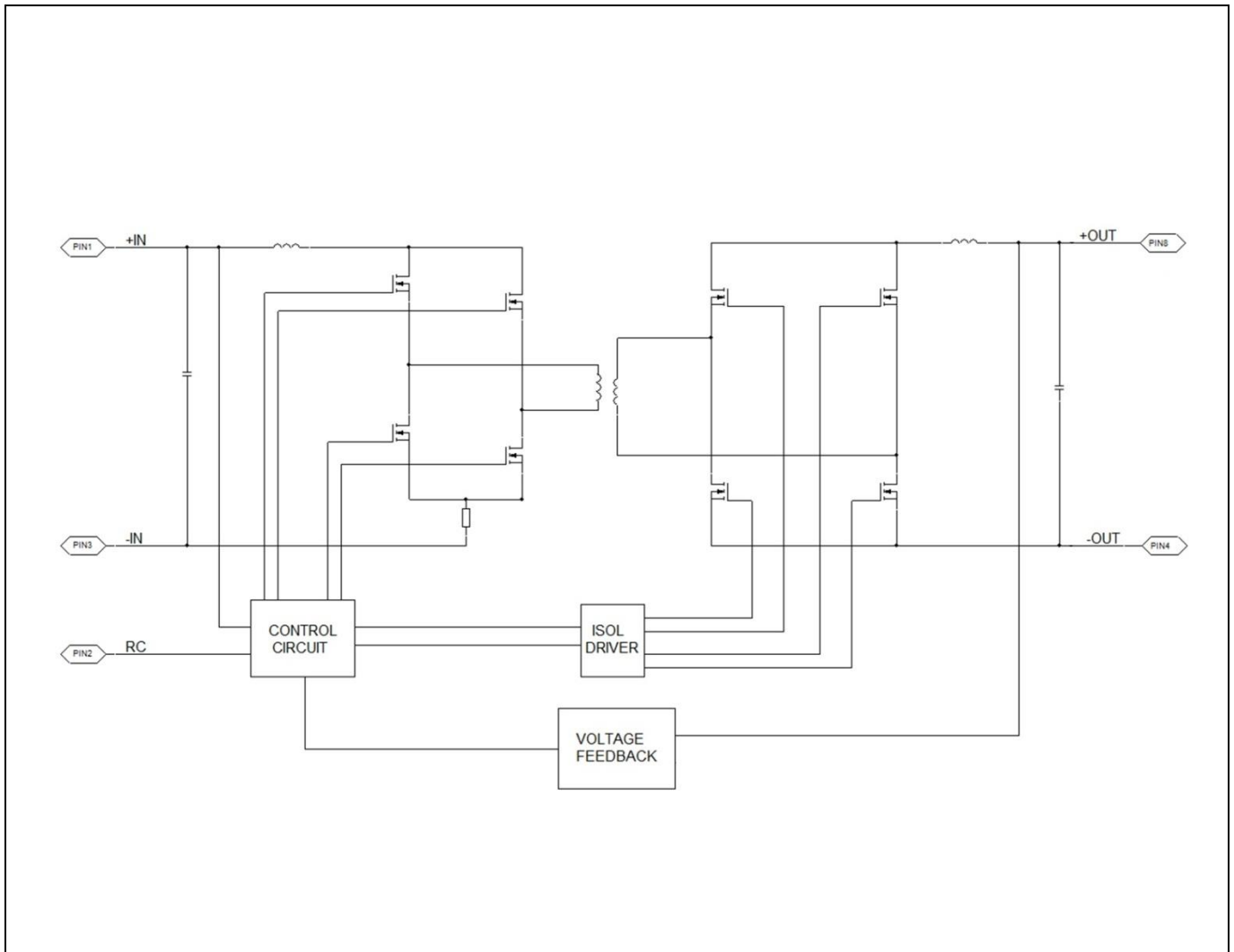

| | |
|-------------------------------------------------------------------------------------------------------|----------------------------------|
| PKB4000D series Fully Regulated DC-DC Converters Input 36-60 V, Output up to 37.5 A / 450 W | 28701-BMR 67406 RevG August 2022 |
| | © Flex |

Electrical Specification
12.0 V, 37.5 A / 450 W
PKB4413D

$T_{P1} = -40$ to $+95^{\circ}\text{C}$, $V_I = 36$ to 60 V, unless otherwise specified under Conditions.
 Typical values given at: $T_{P1} = +25^{\circ}\text{C}$, $V_I = 53$ V, I_O max, unless otherwise specified under Conditions.
 Additional $C_{in} = 100 \mu\text{F}$, $C_{out} = 100\mu\text{F}$. See Operating Information section for selection of capacitor types.

| Characteristics | | Conditions | min | typ | max | Unit |
|-----------------|----------------------------|-----------------------------------|-----|------|------|---------------|
| V_I | Input voltage range | | 36 | | 60 | V |
| V_{loff} | Turn-off input voltage | Decreasing input voltage | 31 | 32.5 | 34 | V |
| V_{lon} | Turn-on input voltage | Increasing input voltage | 34 | 35 | 36 | V |
| C_I | Internal input capacitance | $V_I = 53$ V | | 11 | | μF |
| P_O | Output power | | 0 | | 450 | W |
| η | Efficiency | 50% of max I_O | | 95.8 | | % |
| | | max I_O | | 95.6 | | |
| | | 50% of max I_O , $V_I = 48$ V | | 96.0 | | |
| | | max I_O , $V_I = 48$ V | | 95.6 | | |
| P_d | Power Dissipation | max I_O | | 20.9 | 25.5 | W |
| P_{li} | Input idling power | $I_O = 0$ A, $V_I = 53$ V | | 4.3 | | W |
| P_{RC} | Input standby power | $V_I = 53$ V (turned off with RC) | | 1 | | W |
| f_s | Switching frequency | 0-100 % of max I_O | 390 | 415 | 440 | kHz |

| | | | | | | |
|-----------|-----------------------------------------------------------------|----------------------------------------------------------------------------------------------|-----------|-----------|-------|---------------|
| V_{Oi} | Output voltage initial setting and accuracy | $T_{P1} = +25^{\circ}\text{C}$, $V_I = 53$ V, $I_O = 37.5$ A | 11.76 | 12 | 12.24 | V |
| | Output voltage tolerance band | 0-100% of max I_O , $V_I = 42$ -60 V | 11.64 | | 12.36 | V |
| | Idling voltage | $I_O = 0$ A, $V_I = 42$ -60 V | 11.64 | | 12.36 | V |
| | Line regulation | $V_I = 43$ -60 V, max I_O | | 9 | 40 | mV |
| | Load regulation | $V_I = 53$ V, 10-100% of max I_O | | 1 | 20 | mV |
| V_{tr} | Load transient voltage deviation | $V_I = 53$ V, Load step 25-75-25% of max I_O , $di/dt = 1$ A/ μs , $C_O = 1$ mF | | ± 350 | 500 | mV |
| t_{tr} | Load transient recovery time | | | 50 | 150 | μs |
| t_r | Ramp-up time (from 10-90% of V_{Oi}) | 10-100% of max I_O | | 19 | 22 | ms |
| t_s | Start-up time (from V_I connection to 90% of V_{Oi}) | | | 25 | 28 | ms |
| t_{RC} | RC start-up time (from V_{RC} connection to 90% of V_{Oi}) | | max I_O | | 25 | 28 |
| RC | Sink current, see Note 1 | See operating information | 0.5 | | | mA |
| | Trigger level | Decreasing / Increasing RC-voltage | | 1.5 / 2.5 | | V |
| | Response time | | 0.1 | | 0.5 | ms |
| I_O | Output current | | 0 | | 37.5 | A |
| I_{lim} | Current limit threshold | $T_{P1} < \text{max } T_{P1}$ | 39 | 45 | 53 | A |
| I_{sc} | Short circuit current | $T_{P1} = 25^{\circ}\text{C}$, see Note 2 | | 7 | | A |
| C_{out} | Recommended Capacitive Load | $T_{P1} = 25^{\circ}\text{C}$, see Note 3 | 100 | | 10000 | μF |
| V_{Oac} | Output ripple & noise | See ripple & noise section, V_{Oi} | | 90 | 170 | mVp-p |
| OVP | Over voltage protection | $T_{P1} = +25^{\circ}\text{C}$, $V_I = 53$ V, 50% of max I_O | | 14.5 | | V |

Note 1: Sink current drawn by external device connected to the RC pin

Note 2: RMS current at OCP in hiccup mode

Note 3: Low ESR value

PKB4000D series Fully Regulated DC-DC Converters
 Input 36-60 V, Output up to 37.5 A / 450 W

28701-BMR 67406 RevG August 2022
 © Flex

Typical Characteristics 12.0 V, 37.5 A / 450 W

PKB4413D

Efficiency

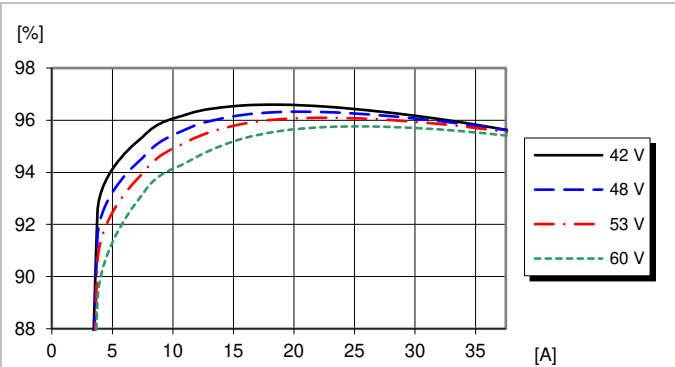

Efficiency vs. load current and input voltage at $T_{P1} = +25^{\circ}\text{C}$.

Power Dissipation

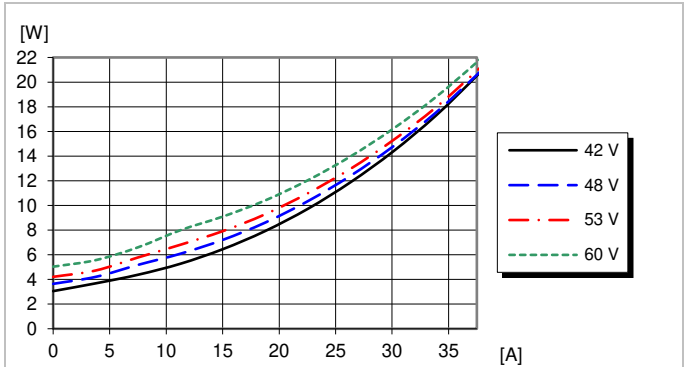

Dissipated power vs. load current and input voltage at $T_{P1} = +25^{\circ}\text{C}$.

Output Characteristics

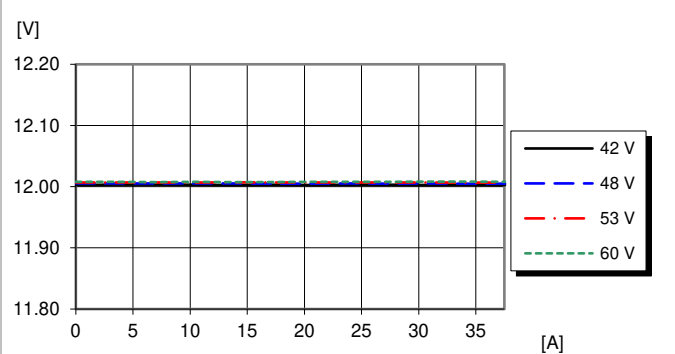

Output voltage vs. load current at $T_{P1} = +25^{\circ}\text{C}$.

Output Characteristics

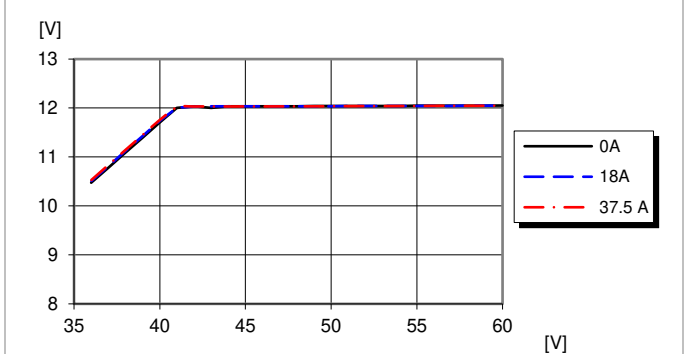

Output voltage vs. input voltage and load current at $T_{P1} = +25^{\circ}\text{C}$.

Current Limit Characteristics

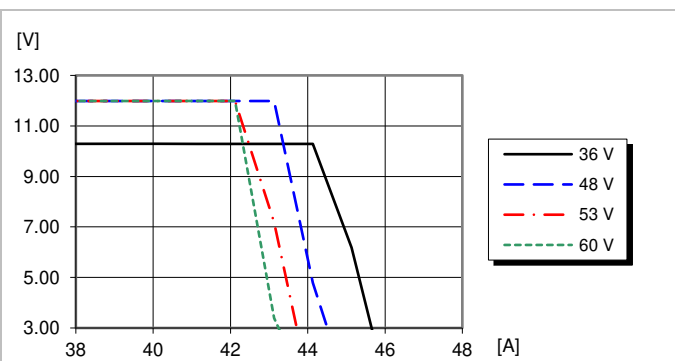

Output voltage vs. load current at $I_O > \max I_O$, $T_{P1} = +25^{\circ}\text{C}$.

Available Power

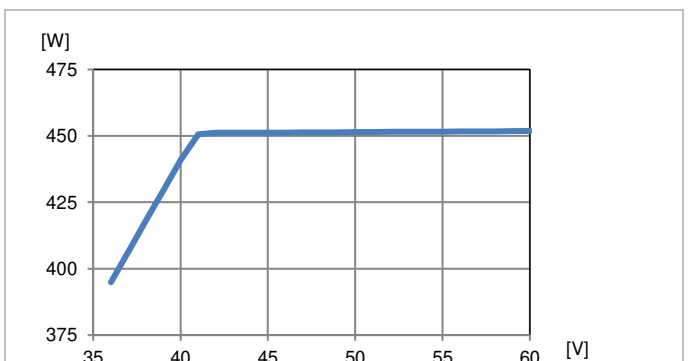

Output power vs. input voltage at $T_{P1} = +25^{\circ}\text{C}$.

PKB4000D series Fully Regulated DC-DC Converters
 Input 36-60 V, Output up to 37.5 A / 450 W

28701-BMR 67406 RevG August 2022
 © Flex

Typical Characteristics 12.0 V, 37.5 A / 450 W

PKB4413D

Start-up

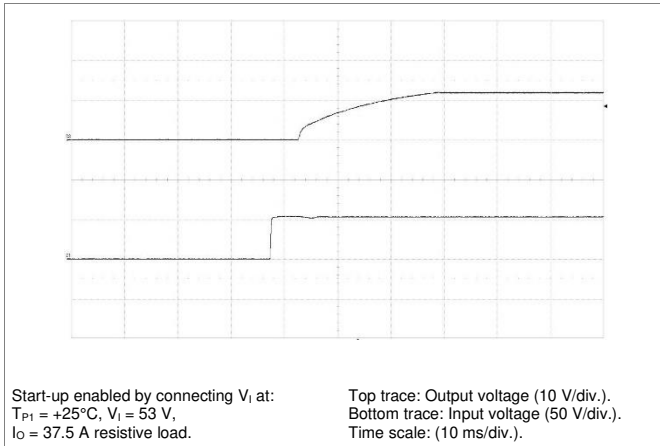

Shut-down

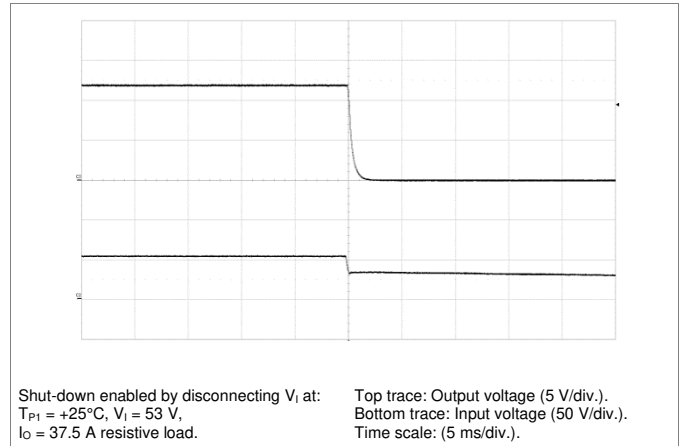

Output Ripple & Noise

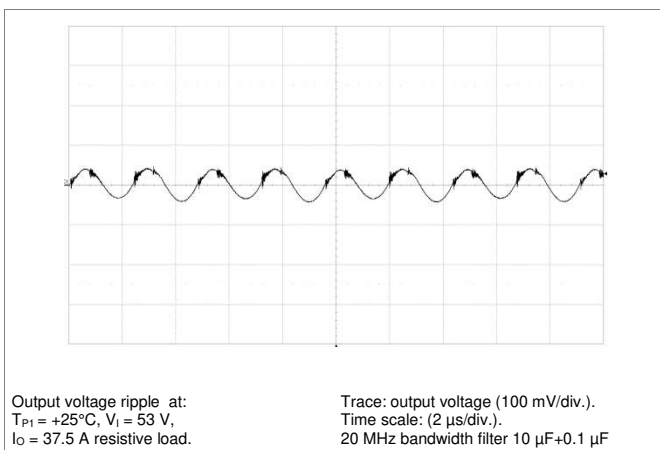

Output Load Transient Response

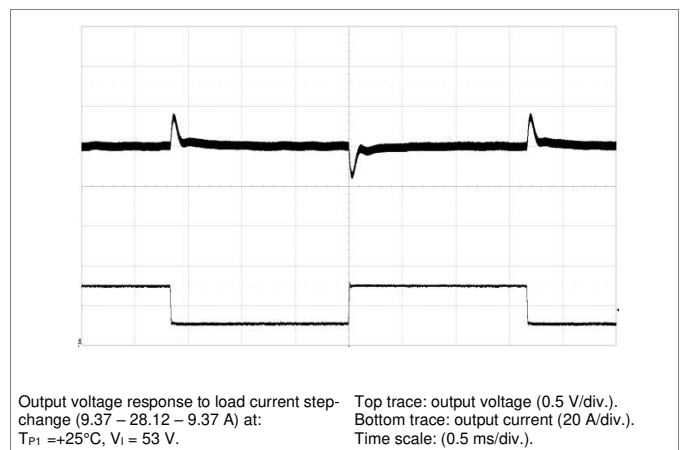

PKB4000D series Fully Regulated DC-DC Converters
 Input 36-60 V, Output up to 37.5 A / 450 W

28701-BMR 67406 RevG August 2022
 © Flex

Typical Characteristics 12 V, 37.5 A / 450 W

PKB4413D

Output Current Derating – Base plate

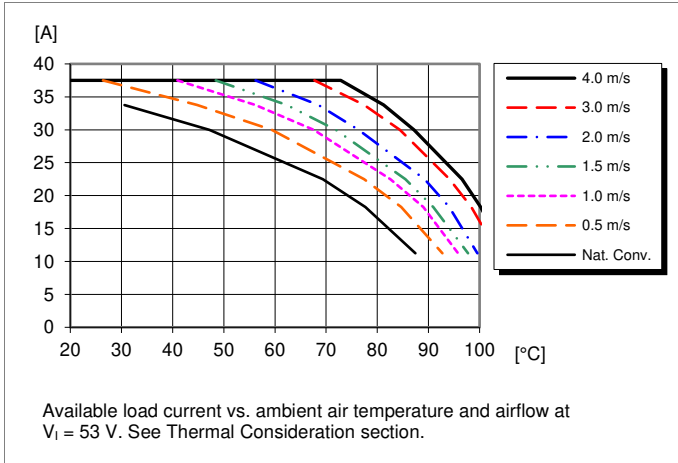

Thermal Resistance – Base plate

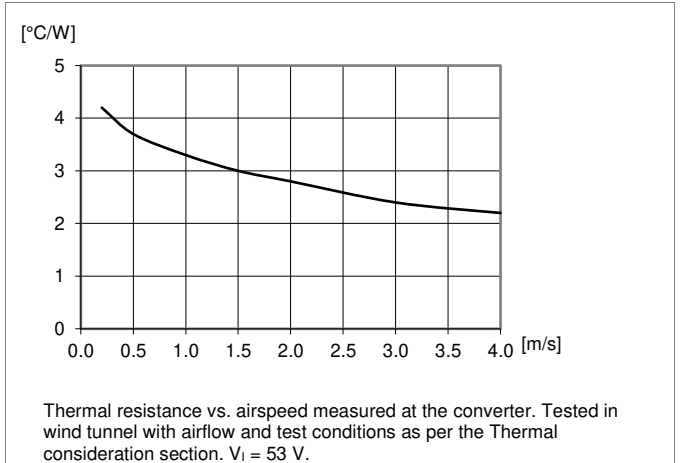

Output Current Derating – Base plate + 1/4" Heat sink

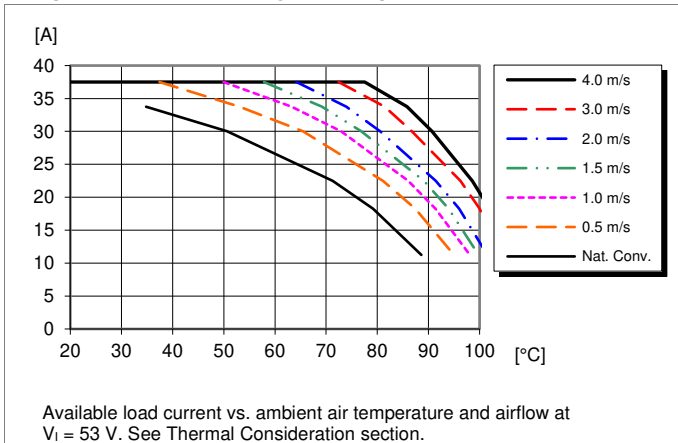

Output Current Derating – Cold wall sealed box

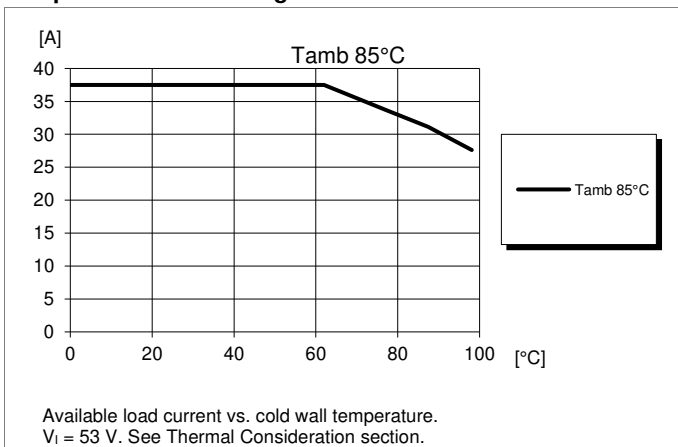

PKB4000D series Fully Regulated DC-DC Converters
 Input 36-60 V, Output up to 37.5 A / 450 W

28701-BMR 67406 RevG August 2022

© Flex

EMC Specification

Conducted EMI measured according to EN55022, CISPR 22 and FCC part 15J (see test set-up). See Design Note 029 for further information. The fundamental switching frequency is 415 kHz for PKB4413D. The EMI characteristics below is measured at $V_I = 53\text{ V}$ and max I_O .

Conducted EMI Input terminal value (typ)

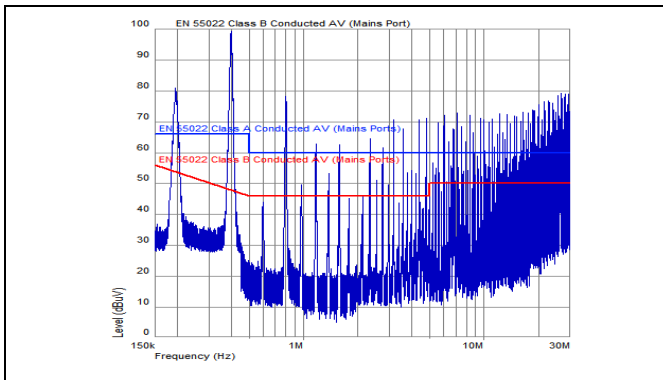

EMI without filter

Optional external filter for class B

Suggested external input filter in order to meet class B in EN 55022, CISPR 22 and FCC part 15J.

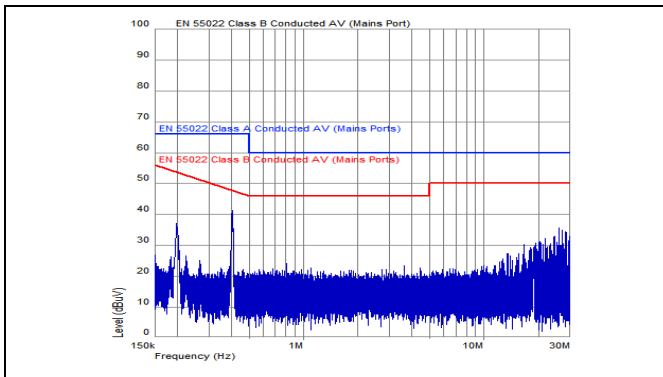
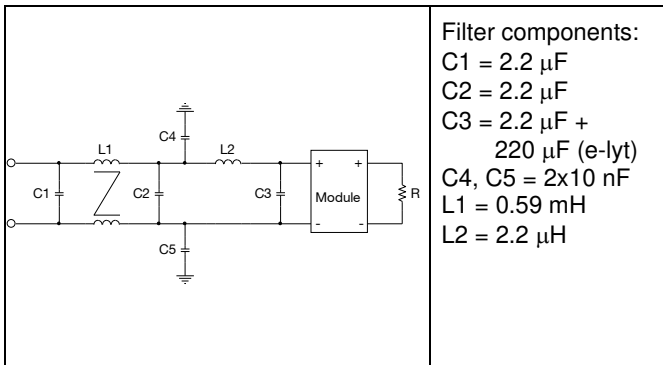

EMI with filter

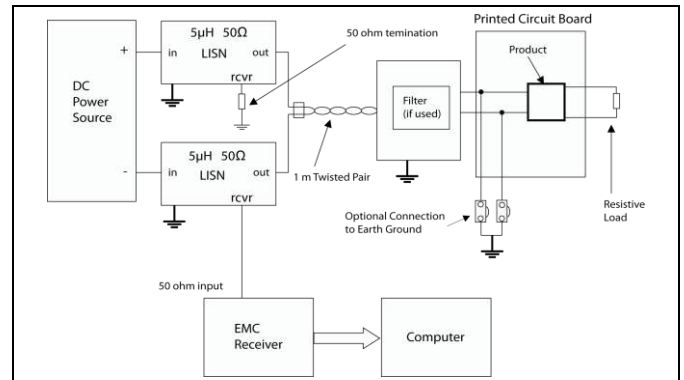

Test set-up

Layout recommendations

The radiated EMI performance of the product will depend on the PWB layout and ground layer design. It is also important to consider the stand-off of the product. If a ground layer is used, it should be connected to the output of the product and to the equipment ground or chassis.

A ground layer will increase the stray capacitance in the PWB and improve the high frequency EMC performance.

Output ripple and noise

Output ripple and noise is measured according to figure below. See Design Note 022 for detailed information.

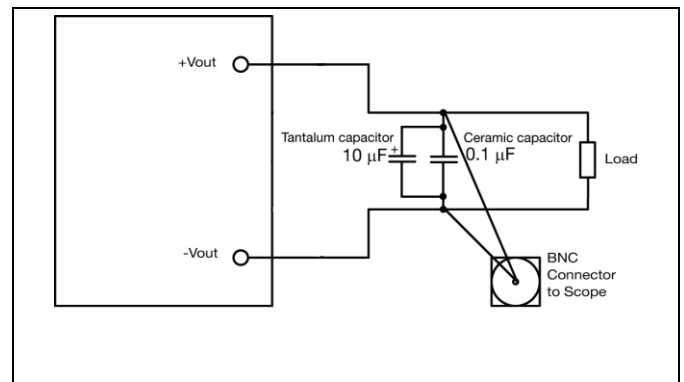

Output ripple and noise test setup

PKB4000D series Fully Regulated DC-DC Converters
Input 36-60 V, Output up to 37.5 A / 450 W

28701-BMR 67406 RevG August 2022

© Flex

Operating information

Input Voltage

The input voltage range 36 to 60 Vdc meets the requirements of the European Telecom Standard ETS 300 132-2 for normal input voltage range in -48 Vdc systems, -40.5 to -57 V.

At input voltages exceeding 60 V, the power loss will be higher than at normal input voltage and T_{P1} must be limited to absolute max +125°C. The absolute maximum continuous input voltage is 72 Vdc.

Above 42 V the product operates with normal regulation with constant output voltage and constant maximum power. Below 42 V the output voltage starts to track the input voltage with a fixed proportion, keeping a duty-cycle guard band for regulation. The product operates down below 36 V before the internal under voltage lock out turns off the product.

Short duration transient disturbances can occur on the DC distribution and input of the product when a short circuit fault occurs on the equipment side of a protective device (fuse or circuit breaker). The voltage level, duration and energy of the disturbance are dependent on the particular DC distribution network characteristics and can be sufficient to damage the product unless measures are taken to suppress or absorb this energy. The transient voltage can be limited by capacitors and other energy absorbing devices like Zener diodes connected across the positive and negative input conductors at a number of strategic points in the distribution network. The end-user must secure that the transient voltage will not exceed the value stated in the Absolute maximum ratings. ETSI TR 100 283 examines the parameters of DC distribution networks and provides guidelines for controlling the transient and reduce its harmful effect.

Turn-off Input Voltage

The products monitor the input voltage and will turn on and turn off at predetermined levels. The minimum hysteresis between turn on and turn off input voltage is 2.5 V.

Remote Control (RC)

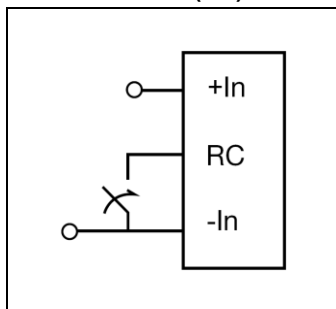

The products are fitted with a remote control function referenced to the primary negative input connection (-In), with negative and positive logic options available. The RC function allows the product to be turned on/off by an external device like a semiconductor or mechanical switch.

The RC pin has an internal pull up resistor of 10 k Ω to +5V. The external device must provide a minimum required sink current to guarantee a voltage not higher than maximum voltage on the RC pin (see Electrical characteristics table).

When the RC pin is left open, the voltage generated on the RC pin is 5 V.

The standard product is provided with “negative logic” RC. To turn off the product the RC pin should be left open, or connected to a voltage higher than 4 V referenced to -In. In situations where it is desired to have the product to power up automatically without the need for control signals or a switch, the RC pin can be wired directly to -In. To turn on the product the RC pin should be lower than 1V referenced to -In.

The second option is “positive logic” remote control, which can be ordered by adding the suffix “P” to the end of the part number. When the RC pin is left open, the product starts up automatically when the input voltage is applied. Turn off is achieved by connecting the RC pin to the -In, or a voltage lower than 1V referenced to -In. The product will restart automatically when this connection is opened.

The RC function incorporates a short delay in order to not trigger on glitches. Typically this filter has a settling time of 0.1-0.5 ms. This setup reduces the risk that the noise may cause the converter to shut down or power up accidentally. See Design Note 021 for detailed information.

Input and Output Impedance

The impedance of both the input source and the load will interact with the impedance of the product. It is important that the input source has low characteristic impedance. The products are designed for stable operation with a minimum of 100 μ F external capacitors connected to the input. The electrolytic capacitors will be degraded in low temperature and the ESR value may increase. The needed input capacitance in low temperature should be equivalent to 100 μ F at 20° C. This means that the input capacitor value may need to be substantially larger to guarantee a stable input at low temperatures. The performance in some applications can be enhanced by addition of external capacitance as described under External Decoupling Capacitors. The minimum required capacitance value depends on the output power and the input voltage. The higher output power the higher input capacitance is needed.

External Decoupling Capacitors

When powering loads with significant dynamic current requirements, the voltage regulation at the load can be improved by addition of decoupling capacitors at the load. The most effective technique is to locate low ESR ceramic and electrolytic capacitors as close to the load as possible, using several parallel capacitors to lower the effective ESR. The ceramic capacitors will handle high-frequency dynamic load changes while the electrolytic capacitors are used to handle low frequency dynamic load changes. It is equally important to use low resistance and low inductance PWB layouts and cabling.

| | |
|-------------------------------------------------------------------------------------------------------|----------------------------------|
| PKB4000D series Fully Regulated DC-DC Converters Input 36-60 V, Output up to 37.5 A / 450 W | 28701-BMR 67406 RevG August 2022 |
| | © Flex |

External decoupling capacitors will become part of the product's control loop. The control loop is optimized for a wide range of external capacitance and the maximum and minimum recommended value that could be used without any additional analysis is found in the Electrical specification. The ESR of the capacitors is a very important parameter. Stable operation is guaranteed with a verified ESR value of $>1 \text{ m}\Omega$ across the output connections.

For further information please contact your local Flex Power Modules representative.

Hybrid Regulated Ratio (HRR)

The product uses two regulation modes. The regulated ratio mode let the regulator track the V_{in} with a fixed proportion, still with a guard band for load and transient regulation. The hybrid regulated mode swaps seamlessly from a ratio regulated mode to a normally regulated mode above a certain input voltage. See Output Characteristics in the Electrical Specification.

HRR uses a fast adaption system and a slow adaption system to react to both fast and slow input voltage changes to provide an input voltage feed-forward function. The fast adaption system prevents the converter to change output voltage very rapid. It filters sudden input voltage changes. The slow adaption system does not let fast input voltage transients through in the regulated ratio mode, it just slowly adapts to the new input voltage. When the input voltage changes the tracking system needs up to 3 ms to fully respond.

In the normally regulated mode the tracking will be saturated and the converter regulates towards a precision reference voltage instead making it almost unsusceptible to transients.

Controlled low external output capacitor charge current at input voltage step

Due to the slow adaption system the HRR product efficiently reduces those charge currents for the external capacitors during an input voltage transient or level shift.

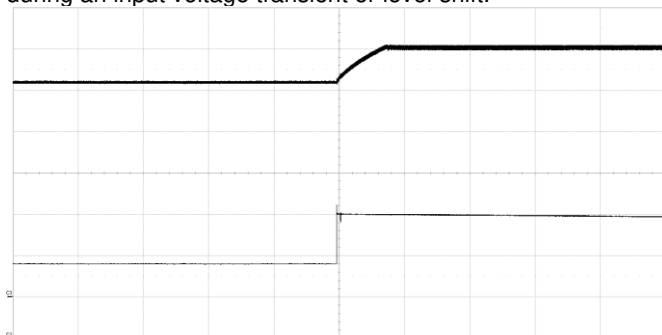

HRR product output at input voltage step 36-60 V, 10 ms/div

Bottom trace – input voltage change 36-60 V, 20 V/div

Top trace – resulting output voltage change, 2 V/div

Input voltage transient suppression

The hybrid regulated product effectively suppresses input voltage transients. This applies to both short duration transients and step-like level shifts of the input voltage. The amplitude of the output transients resulting of short duration transient at the input voltage will be less than 1V. In case of a step-like level shift of the input voltage, the output voltage will rise to a new regulated ratio output voltage or to 12V depending of the final value of the input voltage step. The hybrid regulated ratio prevents overshoots and undershoots in association with this transition. These capabilities significantly reduce the requirements on input transient response of Point of Load regulators fed from this product.

Parallel Operation

This product is not designed for paralleling without using external current sharing circuits. See Design Note 006 for detailed information.

Over Temperature Protection (OTP)

The products are protected from thermal overload by an internal over temperature shutdown circuit. When T_{P1} as defined in thermal consideration section exceeds 130°C the product will shut down. The product will make continuous attempts to start up (non-latching mode) and resume normal operation automatically when the temperature has dropped $>10^{\circ}\text{C}$ below the temperature threshold.

Over Voltage Protection (OVP)

The products have output over voltage protection that will shut down the product in over voltage conditions. The product will make continuous attempts to start up (non-latching mode) and resume normal operation automatically after removal of the over voltage condition. However, at certain conditions the output voltage can be limited to a lower output voltage than the OVP trip point.

Over Current Protection (OCP)

The products include current limiting circuitry for protection at continuous overload. The OCP works in a hiccup mode and will make continous attempts to start up and will resume normal operation automatically after removal of the over current condition. The load distribution should be designed for the specified maximum output short circuit current.

Pre-bias Start-up

The product has a Pre-bias start up functionality and will not sink current during start up if a pre-bias load is present at the output terminals.

PKB4000D series Fully Regulated DC-DC Converters
 Input 36-60 V, Output up to 37.5 A / 450 W

28701-BMR 67406 RevG August 2022

© Flex

Thermal Consideration

General

The products are designed to operate in different thermal environments and sufficient cooling must be provided to ensure reliable operation.

For products mounted on a PWB without a baseplate attached, cooling is achieved mainly by conduction, from the pins to the host board, and convection, which is dependant on the airflow across the product. Increased airflow enhances the cooling of the product. The Output Current Derating graph found in the Output section for each model provides the available output current vs. ambient air temperature and air velocity at $V_I = 53\text{ V}$.

The product is tested on a 254 x 254 mm, 35 μm (1 oz), 16-layer test board mounted vertically in a wind tunnel with a cross-section of 608 x 203 mm.

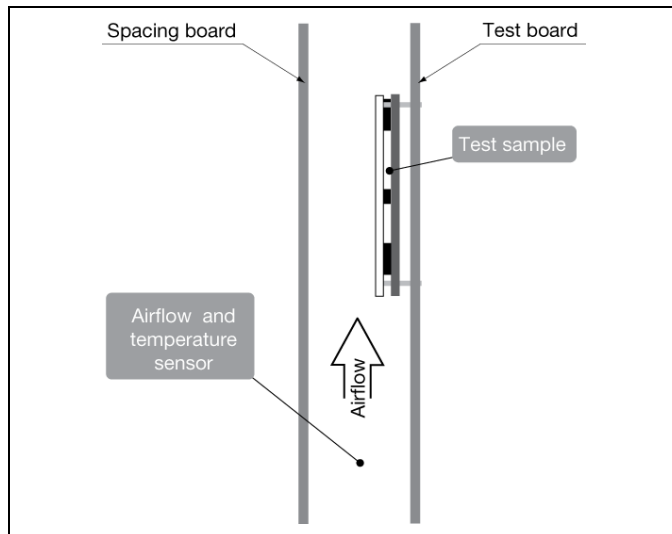

For products with baseplate used in a sealed box/cold wall application, cooling is achieved mainly by conduction through the cold wall. The Output Current Derating graphs are found in the Output section for each model. The product performance has been tested in a sealed box presented in the figure below. The ambient temperature (inside the box) has been set to 85°C. The cold wall temperature varied. See Design Note 028 for further details.

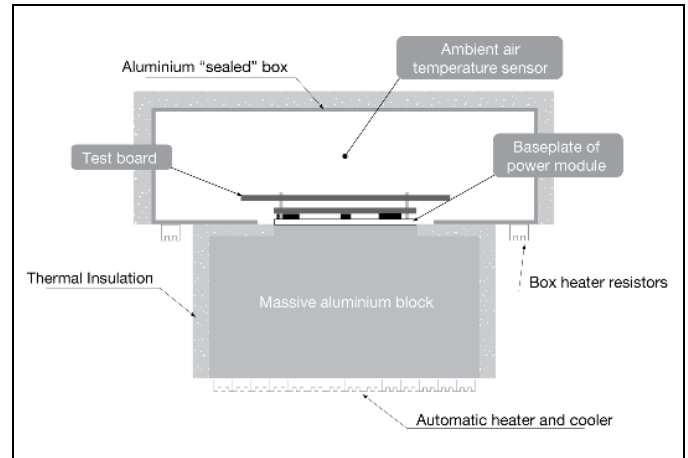

Definition of product operating temperature

The temperature at the positions (T_{P1} , T_{P2}) should not exceed the maximum temperatures in the table below. The number of measurement points may vary with different thermal design and topology. Temperatures above maximum measured at the reference point P1, P2 are not allowed and may cause permanent damage.

| Position | Description | Max Temp. |
|----------|-------------------------|------------------------------|
| P1 | Driver, Reference point | $T_{P1} = 125^\circ\text{C}$ |
| P2 | PWB | $T_{P2} = 125^\circ\text{C}$ |

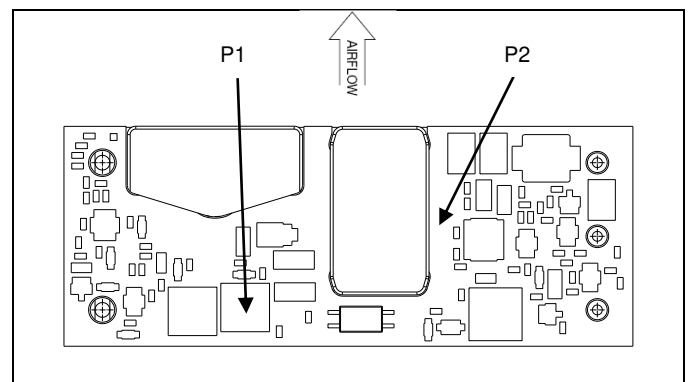

Pin side (baseplate module)

PKB4000D series Fully Regulated DC-DC Converters
 Input 36-60 V, Output up to 37.5 A / 450 W

28701-BMR 67406 RevG August 2022

© Flex

Ambient Temperature Calculation

For products with base plate the maximum allowed ambient temperature can be calculated by using the thermal resistance.

- The power loss is calculated by using the formula $((1/\eta) - 1) \times \text{output power} = \text{power losses (Pd)}$.
 η = efficiency of product. E.g. 96% = 0.96
- Find the thermal resistance (Rth) in the Thermal Resistance graph found in the Output section for each model. **Note that the thermal resistance can be significantly reduced if a heat sink is mounted on the top of the base plate.**

Calculate the temperature increase (ΔT).
 $\Delta T = R_{th} \times P_d$

- Max allowed ambient temperature is:
 $\text{Max } T_{P1} - \Delta T$.

E.g. PKB4413D at 1m/s:

- $((\frac{1}{0.96}) - 1) \times 450 \text{ W} = 18.8 \text{ W}$
- $18.8 \text{ W} \times 3.3^\circ\text{C/W} = 62^\circ\text{C}$
- $125^\circ\text{C} - 62^\circ\text{C} = \text{max allowed ambient temperature is } 63^\circ\text{C}$

The actual temperature will be dependent on several factors such as the PWB size, number of layers and direction of airflow.

Connections

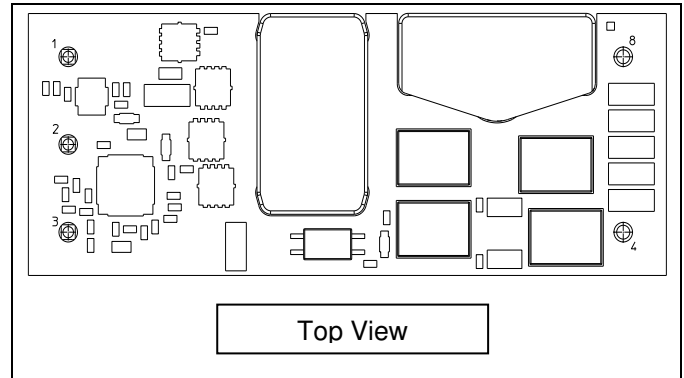

| Pin | Designation | Function |
|-----|-------------|-----------------|
| 1 | +In | Positive Input |
| 2 | RC | Remote Control |
| 3 | -In | Negative Input |
| 4 | -Out | Negative Output |
| 8 | +Out | Positive Output |

PKB4000D series Fully Regulated DC-DC Converters
 Input 36-60 V, Output up to 37.5 A / 450 W

28701-BMR 67406 RevG August 2022

© Flex

Mechanical Information - Hole Mount, Base Plate Version

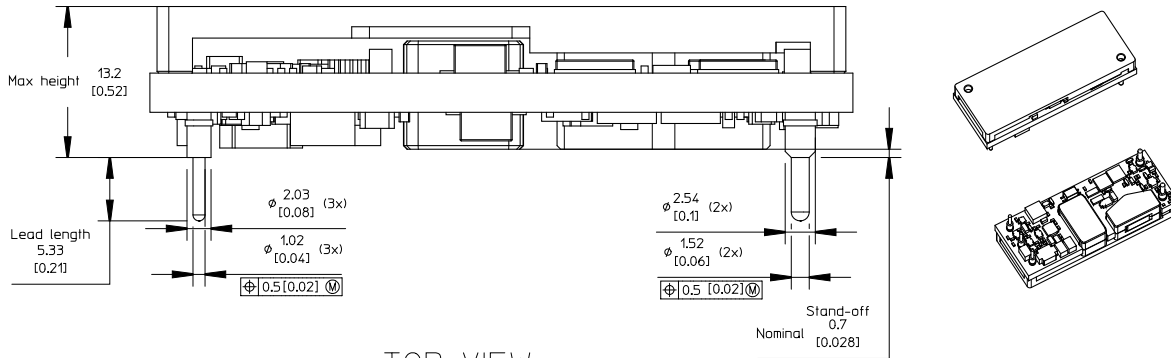

TOP VIEW

Pin positions according to recommended footprint

Table 1

| | Lead length |
|----------|--------------|
| Standard | 5.33 [0.210] |
| LA | 3.69 [0.145] |
| LB | 4.57 [0.180] |
| LC | 2.79 [0.110] |

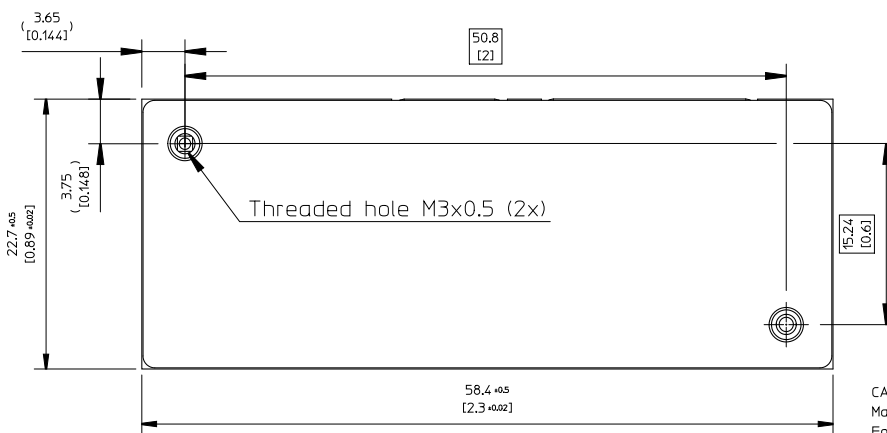

CASE

Material: Aluminium
 For screw attachment apply mounting torque of max 0.44 Nm [3.9 lbf in.]. M3 screws must not protrude more than 2.5 mm [0.098] in to the base plate.

PIN SPECIFICATIONS

Pin 1-4 & 8 Material: Copper alloy
 Plating: Min Au 0.1 μ m over 1-3 μ m Ni.

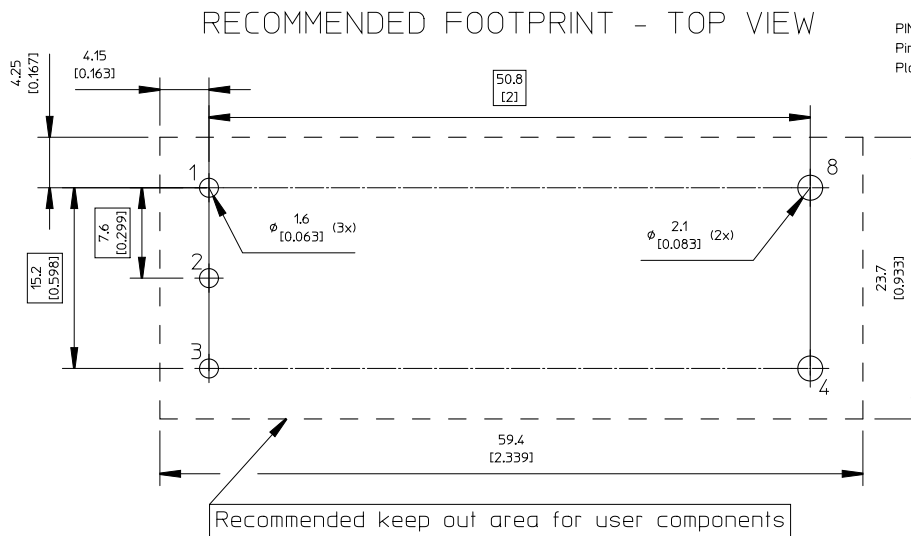

Weight: Typical 40 g
 All dimensions in mm [inch]
 Tolerances unless specified:
 x.x \pm 0.50 [0.02]
 x.xx \pm 0.25 [0.01]
 (not applied on footprint or typical values)



PKB400D series Fully Regulated DC-DC Converters
 Input 36-60 V, Output up to 37.5 A / 450 W

28701-BMR 67406 RevG August 2022

© Flex

Mechanical Information – Surface Mount Version

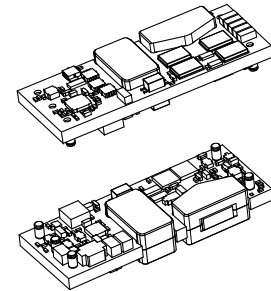
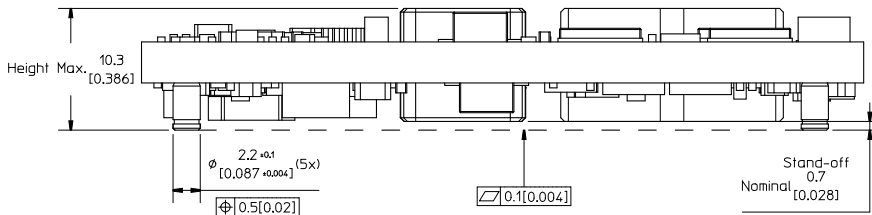

TOP VIEW

Pin positions according to recommended footprint

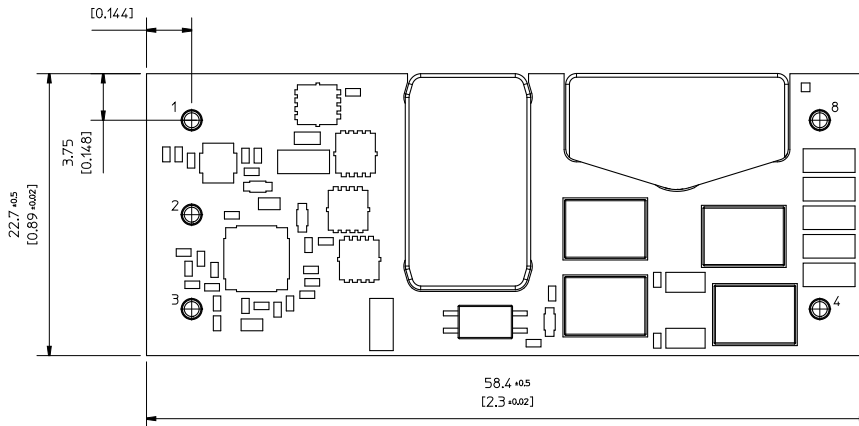

PIN SPECIFICATIONS
 Pin 1-4 & 8 Material: Copper alloy
 Plating: Min 0.1 µm Au over 1-3 µm Ni.

RECOMMENDED FOOTPRINT - TOP VIEW

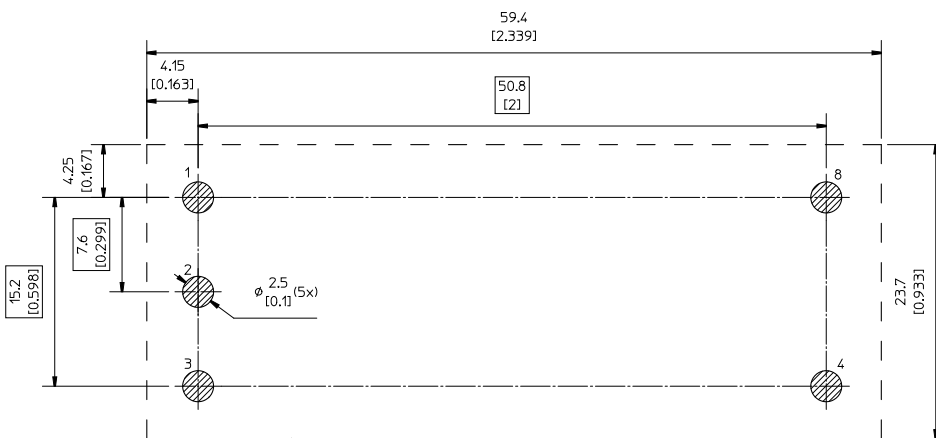

Recommended pad dimensions are not for reference. It is the end users decision based in different situations like production processes, substrate thickness etc.

Weight: Typical 26 g
 All dimensions in mm [inch]
 Tolerances unless specified:
 x.x ±0.50 [0.02]
 x.xx±0.25 [0.01]
 (not applied on footprint or typical values)

Recommended keep out area for user components



PKB4000D series Fully Regulated DC-DC Converters
 Input 36-60 V, Output up to 37.5 A / 450 W

28701-BMR 67406 RevG August 2022

© Flex

Soldering Information - Surface Mounting

The surface mount product is intended for forced convection or vapor phase reflow soldering in SnPb and Pb-free processes.

The reflow profile should be optimised to avoid excessive heating of the product. It is recommended to have a sufficiently extended preheat time to ensure an even temperature across the host PWB and it is also recommended to minimize the time in reflow.

A no-clean flux is recommended to avoid entrapment of cleaning fluids in cavities inside the product or between the product and the host board, since cleaning residues may affect long time reliability and isolation voltage.

| General reflow process specifications | | SnPb eutectic | Pb-free |
|-----------------------------------------------|---------------|---------------|-----------|
| Average ramp-up ($T_{PRODUCT}$) | | 3°C/s max | 3°C/s max |
| Typical solder melting (liquidus) temperature | T_L | 183°C | 221°C |
| Minimum reflow time above T_L | | 60 s | 60 s |
| Minimum pin temperature | T_{PIN} | 210°C | 235°C |
| Peak product temperature | $T_{PRODUCT}$ | 225°C | 260°C |
| Average ramp-down ($T_{PRODUCT}$) | | 6°C/s max | 6°C/s max |
| Maximum time 25°C to peak | | 6 minutes | 8 minutes |

Lead-free (Pb-free) solder processes

For Pb-free solder processes, a pin temperature (T_{PIN}) in excess of the solder melting temperature (T_L , 217 to 221°C for SnAgCu solder alloys) for more than 60 seconds and a peak temperature of 245°C on all solder joints is recommended to ensure a reliable solder joint.

Maximum Product Temperature Requirements

Top of the product PWB near pin 2 is chosen as reference location for the maximum (peak) allowed product temperature ($T_{PRODUCT}$) since this will likely be the warmest part of the product during the reflow process.

SnPb solder processes

For SnPb solder processes, the product is qualified for MSL 1 according to IPC/JEDEC standard J-STD-020C.

During reflow $T_{PRODUCT}$ must not exceed 225 °C at any time.

Pb-free solder processes

For Pb-free solder processes, the product is qualified for MSL 3 according to IPC/JEDEC standard J-STD-020C.

During reflow $T_{PRODUCT}$ must not exceed 260 °C at any time.

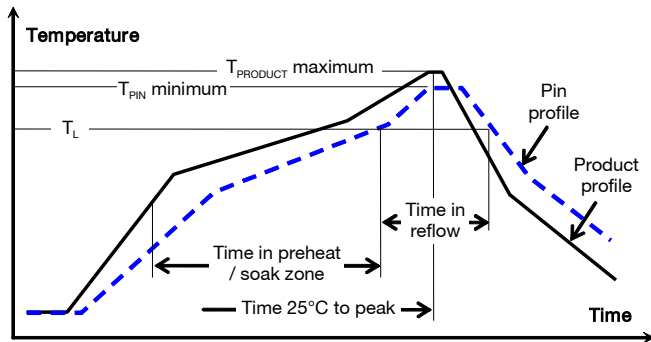

Minimum Pin Temperature Recommendations

Pin number 4 is chosen as reference location for the minimum pin temperature recommendation since this will likely be the coolest solder joint during the reflow process.

SnPb solder processes

For SnPb solder processes, a pin temperature (T_{PIN}) in excess of the solder melting temperature, (T_L , 183°C for Sn63Pb37) for more than 60 seconds and a peak temperature of 220°C is recommended to ensure a reliable solder joint.

For dry packed products only: depending on the type of solder paste and flux system used on the host board, up to a recommended maximum temperature of 245°C could be used, if the products are kept in a controlled environment (dry pack handling and storage) prior to assembly.

Dry Pack Information

Products intended for Pb-free reflow soldering processes are delivered in standard moisture barrier bags according to IPC/JEDEC standard J-STD-033 (Handling, packing, shipping and use of moisture/reflow sensitivity surface mount devices).

Using products in high temperature Pb-free soldering processes requires dry pack storage and handling. In case the products have been stored in an uncontrolled environment and no longer can be considered dry, the modules must be baked according to J-STD-033.

Thermocoupler Attachment

Top of PWB near pin 2 for measurement of maximum product temperature, $T_{PRODUCT}$

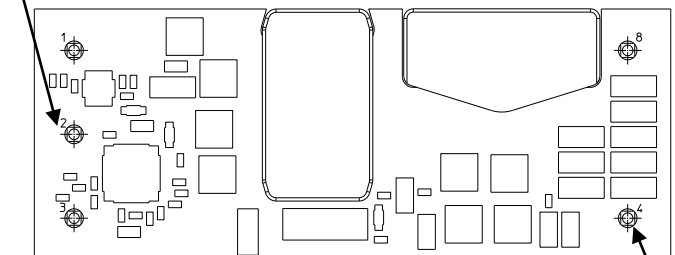

Pin 4 for measurement of minimum pin (solder joint) temperature, T_{PIN}

PKB4000D series Fully Regulated DC-DC Converters
 Input 36-60 V, Output up to 37.5 A / 450 W

28701-BMR 67406 RevG August 2022

© Flex

Soldering Information - Hole Mounting

The hole mounted product is intended for plated through hole mounting by wave or manual soldering. The pin temperature is specified to maximum to 270°C for maximum 10 seconds.

A maximum preheat rate of 4°C/s and maximum preheat temperature of 150°C is suggested. When soldering by hand, care should be taken to avoid direct contact between the hot soldering iron tip and the pins for more than a few seconds in order to prevent overheating.

A no-clean flux is recommended to avoid entrapment of cleaning fluids in cavities inside the product or between the product and the host board. The cleaning residues may affect long time reliability and isolation voltage.

Delivery Package Information

The products are delivered in antistatic injection molded trays (Jedec design guide 4.10D standard) and in antistatic trays.

| Tray Specifications – SMD | |
|---------------------------|------------------------------------------------------|
| Material | Antistatic PPE |
| Surface resistance | $10^5 < \text{Ohm/square} < 10^{12}$ |
| Bakability | The trays can be baked at maximum 125°C for 48 hours |
| Tray thickness | 25.0 mm 0.984 [inch] |
| Box capacity | 80 products (4 full trays/box) |
| Tray weight | 150 g empty, 630 g full tray |

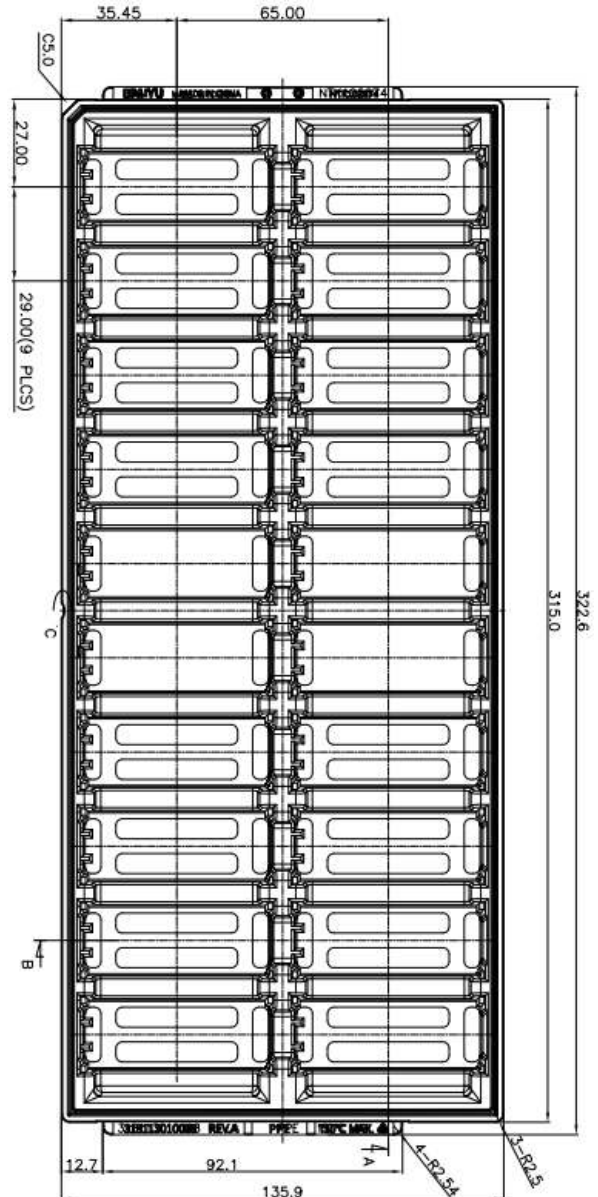

JEDEC standard tray for 2x10 = 20 products.
 All dimensions in mm [inch]
 Tolerances: X.x ±0.26 [0.01], X.xx ±0.13 [0.005]
 Note: pick up positions refer to center of pocket.
 See mechanical drawing for exact location on product.

PKB4000D series Fully Regulated DC-DC Converters
 Input 36-60 V, Output up to 37.5 A / 450 W

28701-BMR 67406 RevG August 2022

© Flex

| Tray Specifications – Through hole version | |
|--------------------------------------------|------------------------------------------------------------------------------------------------------------------------------|
| Material | PE Foam, dissipative |
| Surface resistance | $10^5 < \text{Ohm/square} < 10^{12}$ |
| Bakability | The trays are not bakable |
| Tray thickness | 22 mm [0.866 inch] |
| Box capacity | 100 products (4 full trays/box) Open frame 25 products (1 full tray/box) Base plate |
| Tray weight | Product – Open frame 654 g full tray, 54 g empty tray Product – Base plate option 1000 g full tray, 54 g empty tray |

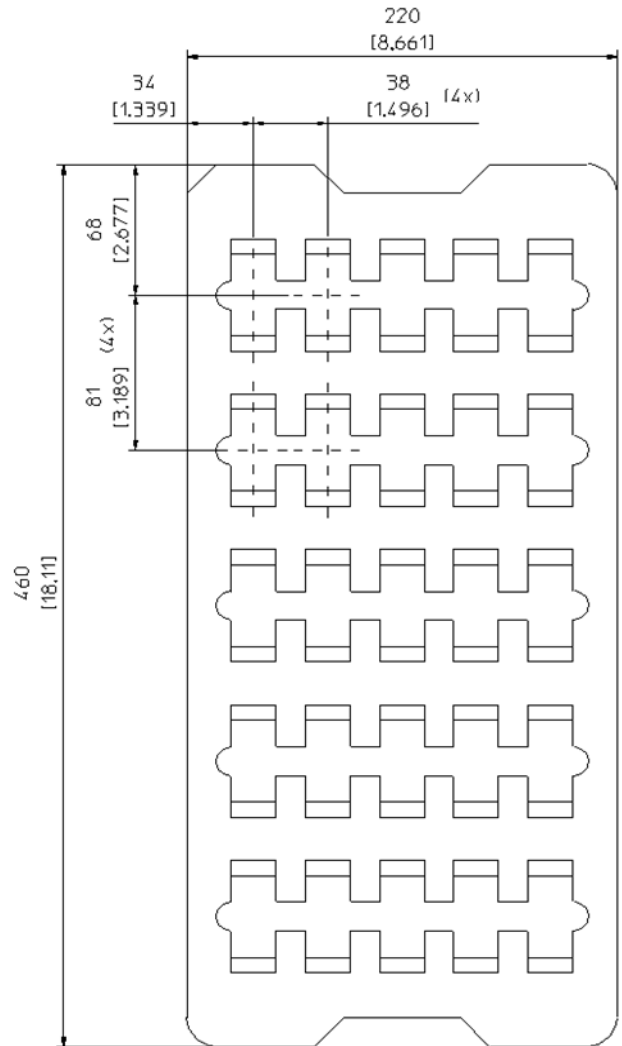

Soft tray for open frame & base plate version

| | |
|-------------------------------------------------------------------------------------------------------|----------------------------------|
| PKB4000D series Fully Regulated DC-DC Converters Input 36-60 V, Output up to 37.5 A / 450 W | 28701-BMR 67406 RevG August 2022 |
| | © Flex |

Product Qualification Specification

| Characteristics | | | |
|---------------------------------------------|------------------------------------------------------------|-----------------------------------------------------------------------|---------------------------------------------------------------------|
| External visual inspection | IPC-A-610 | | |
| Change of temperature (Temperature cycling) | IEC 60068-2-14 Na | Temperature range Number of cycles Dwell/transfer time | -40 to 100°C 1000 15 min/0-1 min |
| Cold (in operation) | IEC 60068-2-1 Ad | Temperature T _A Duration | -45°C 72 h |
| Damp heat | IEC 60068-2-67 Cy | Temperature Humidity Duration | 85°C 85 % RH 1000 hours |
| Dry heat | IEC 60068-2-2 Bd | Temperature Duration | 125°C 1000 h |
| Electrostatic discharge susceptibility | IEC 61340-3-1, JESD 22-A114 IEC 61340-3-2, JESD 22-A115 | Human body model (HBM) Machine Model (MM) | Class 2, 2000 V Class 3, 200 V |
| Immersion in cleaning solvents | IEC 60068-2-45 XA, method 2 | Water Glycol ether Isopropyl alcohol | 55°C 35°C 35°C |
| Mechanical shock | IEC 60068-2-27 Ea | Peak acceleration Duration | 100 g 6 ms |
| Moisture reflow sensitivity ¹ | J-STD-020C | Level 1 (SnPb-eutectic) Level 3 (Pb Free) | 225°C 260°C |
| Operational life test | MIL-STD-202G, method 108A | Duration | 1000 h |
| Resistance to soldering heat ² | IEC 60068-2-20 Tb, method 1A | Solder temperature Duration | 270°C 10-13 s |
| Robustness of terminations | IEC 60068-2-21 Test Ua1 IEC 60068-2-21 Test Ue1 | Through hole mount products Surface mount products | All leads All leads |
| Solderability | IEC 60068-2-58 test Td ¹ | Preconditioning Temperature, SnPb Eutectic Temperature, Pb-free | 150°C dry bake 16 h 215°C 235°C |
| | IEC 60068-2-20 test Ta ² | Preconditioning Temperature, SnPb Eutectic Temperature, Pb-free | Steam ageing 235°C 245°C |
| Vibration, broad band random | IEC 60068-2-64 Fh, method 1 | Frequency Spectral density Duration | 10 to 500 Hz 0.07 g ² /Hz 10 min in each direction |

Notes
¹ Only for products intended for reflow soldering (surface mount products)

² Only for products intended for wave soldering (plated through hole products)