

GlobTek, Inc. www.globtek.com 186 Veterans Drive, Northvale, NJ 07647 Tel. (201) 784-1000 Fax (201) 784-0111	Drawing Title: HOSPITAL GRADE WITH GREEN DOT, NEMA 6-20P MALE 2 PRONG PLUG WITH GROUND to NORTH AMERICAN IEC60320-C19 CONNECTOR, GT Cable #136: 12 / 3 Conductors, 10.8mm OD, SJT, 60 Deg.C, 300V, BLK/WHT/GRN, Approvals: , 5000±50mm, GlobTek Black	
	Model No. Power Cord	
	Part No./Ordering No. 360M13616F427032(R)	Rev A1

CUSTOMIZED LENGTHS, COLORS, CABLE TYPES, TERMINATIONS/PLUGS/RECEPTACLES AVAILABLE UPON REQUEST. ADDITIONAL PLUG OPTIONS ARE AVAILABLE AT <https://www.globtek.com/connectors/> STANDARD PLUGS AND CONNECTORS CAN BE SEEN ONLINE AT <https://www.globtek.com/connectors/> ACTUAL CONNECTORS, OVERMOLDS, FERRITES MAY VARY SLIGHTLY FROM THE PICTURE BELOW DIMENSIONS ARE IN MM UNLESS SPECIFIED OTHERWISE

In Addition to GlobTek Inc.'s renewed ISO9001:2008 - Quality Management System Certification, GlobTek Inc. is now certified to:

ISO13485:2003 - Medical Devices Quality Management System Certification
ISO14001:2004 - Environmental Management System Certification

ISO Certificates are available online at <https://www.globtek.com/iso-certificates/>
Prop 65 Statement: <https://en.globtek.com/prop-65-statement.pdf>

The acceptance of this specification and use of the product described in this document indicates the acceptance and binding of the customer to Globtek TERMS AND CONDITIONS (attached to the end of this document), which supersede all other agreements, terms, and conditions (<https://en.globtek.com/terms-and-conditions/>).

The purchaser of this product (Customer) agrees that it is their sole responsibility to determine suitability/fitness of the product described in this specification for their application and to take precautions for protection against any hazards attendant to the handling and use of the product.

Footnote:

GlobTek Inc. will not be liable for the safety and performance of these power supplies if unauthorized access and repair occurs. End user should consult applicable UL, CSA or EN standards for proper installation instruction.

Limitation of Use:

GlobTek products are intended for use with commercial, medical, and/or industrial equipment only. GlobTek product are not authorized for use as mission critical components in life support hazardous environment, nuclear or aircraft applications without prior written approval from the CEO of GlobTek Inc.
Contents of this document are subject to change without prior notice.

Customer Approval of Specification:

Please approve, sign and send back to GlobTek so we can complete order processing.
A delay in receipt of this form will delay delivery schedule.

Company Name: _____	Customer P/N: _____
Quote Number: _____	Date: _____
Authorized Representative Name: _____	Authorized Representative Signature: _____

GlobTek, Inc. www.globtek.com 186 Veterans Drive, Northvale, NJ 07647 Tel. (201) 784-1000 Fax (201) 784-0111	Drawing Title: HOSPITAL GRADE WITH GREEN DOT, NEMA 6-20P MALE 2 PRONG PLUG WITH GROUND to NORTH AMERICAN IEC60320-C19 CONNECTOR, GT Cable #136: 12 / 3 Conductors, 10.8mm OD, SJT, 60 Deg.C, 300V, BLK/WHT/GRN, Approvals: , 5000±50mm, GlobTek Black	
	Model No. Power Cord	
	Part No./Ordering No. 360M13616F427032(R)	Rev A1

CUSTOMIZED LENGTHS, COLORS, CABLE TYPES, TERMINATIONS/PLUGS/RECEPTACLES AVAILABLE UPON REQUEST. ADDITIONAL PLUG OPTIONS ARE AVAILABLE AT <https://www.globtek.com/connectors/> STANDARD PLUGS AND CONNECTORS CAN BE SEEN ONLINE AT <https://www.globtek.com/connectors/> ACTUAL CONNECTORS, OVERMOLDS, FERRITES MAY VARY SLIGHTLY FROM THE PICTURE BELOW DIMENSIONS ARE IN MM UNLESS SPECIFIED OTHERWISE

REVISION HISTORY

REV	DESCRIPTION	SUB	DATE	APPROVED
A1	Update hanking from 200±20 mm to 250±30 mm	QA	09/15/2022	QA
A	Initial release	QA	11/10/2021	QA

Cordset Information:

CordsetColor:GlobTek Black

Cord Length (mm):5000±50

NOTES:

Cord, Plug and Connector must be marked with approval symbols of file number(s)

GlobTek, Inc. www.globtek.com 186 Veterans Drive, Northvale, NJ 07647 Tel. (201) 784-1000 Fax (201) 784-0111	Drawing Title: HOSPITAL GRADE WITH GREEN DOT, NEMA 6-20P MALE 2 PRONG PLUG WITH GROUND to NORTH AMERICAN IEC60320-C19 CONNECTOR, GT Cable #136: 12 / 3 Conductors, 10.8mm OD, SJT, 60 Deg.C, 300V, BLK/WHT/GRN, Approvals: , 5000±50mm, GlobTek Black
	Model No. Power Cord
Part No./Ordering No. 360M13616F427032(R)	Rev A1

CUSTOMIZED LENGTHS, COLORS, CABLE TYPES, TERMINATIONS/PLUGS/RECEPTACLES AVAILABLE UPON REQUEST. ADDITIONAL PLUG OPTIONS ARE AVAILABLE AT <https://www.globtek.com/connectors/> STANDARD PLUGS AND CONNECTORS CAN BE SEEN ONLINE AT <https://www.globtek.com/connectors/> ACTUAL CONNECTORS, OVERMOLDS, FERRITES MAY VARY SLIGHTLY FROM THE PICTURE BELOW DIMENSIONS ARE IN MM UNLESS SPECIFIED OTHERWISE

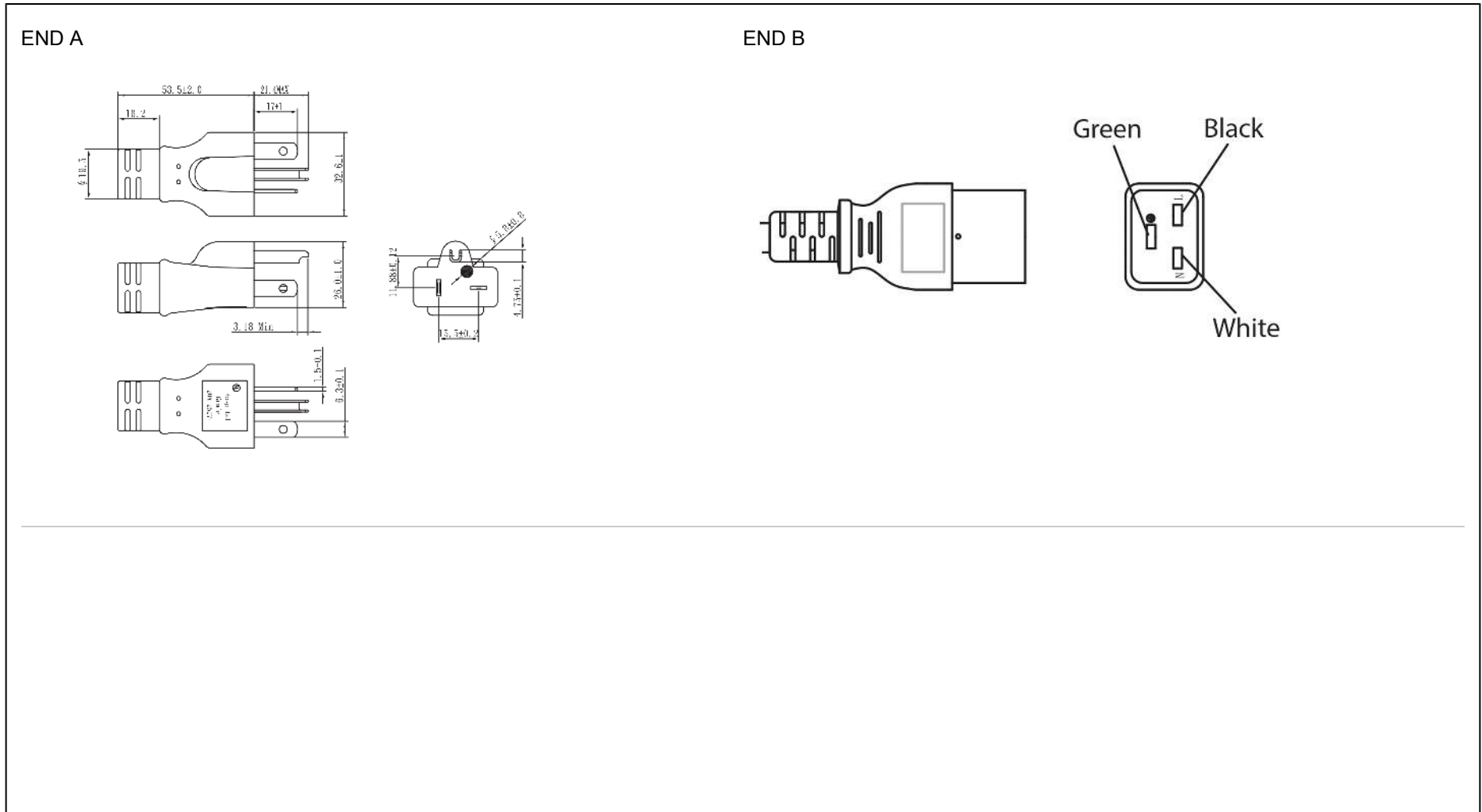

PROPRIETARY INFORMATION

PROPRIETARY OF GLOBTEK, INC. ANY REPRODUCTION, DISCLOSURE OR USE OF THIS DRAWING, IN WHOLE OR IN PART, IS HEREBY PROHIBITED EXCEPT AS SPECIFIED IN WRITING BY GLOBTEK, INC. © GlobTek, Inc. 2021 - 2023

quest /10/04/2023 8:02:48 PM CLONED FROM 360M1368F27032(R)

GlobTek, Inc. www.globtek.com 186 Veterans Drive, Northvale, NJ 07647 Tel. (201) 784-1000 Fax (201) 784-0111	Drawing Title: HOSPITAL GRADE WITH GREEN DOT, NEMA 6-20P MALE 2 PRONG PLUG WITH GROUND to NORTH AMERICAN IEC60320-C19 CONNECTOR, GT Cable #136: 12 / 3 Conductors, 10.8mm OD, SJT, 60 Deg.C, 300V, BLK/WHT/GRN, Approvals: , 5000±50mm, GlobTek Black	
	Model No. Power Cord	Part No./Ordering No. 360M13616F427032(R)

CUSTOMIZED LENGTHS, COLORS, CABLE TYPES, TERMINATIONS/PLUGS/RECEPTACLES AVAILABLE UPON REQUEST. ADDITIONAL PLUG OPTIONS ARE AVAILABLE AT <https://www.globtek.com/connectors/> STANDARD PLUGS AND CONNECTORS CAN BE SEEN ONLINE AT <https://www.globtek.com/connectors/> ACTUAL CONNECTORS, OVERMOLDS, FERRITES MAY VARY SLIGHTLY FROM THE PICTURE BELOW DIMENSIONS ARE IN MM UNLESS SPECIFIED OTHERWISE

CABLE IMAGE

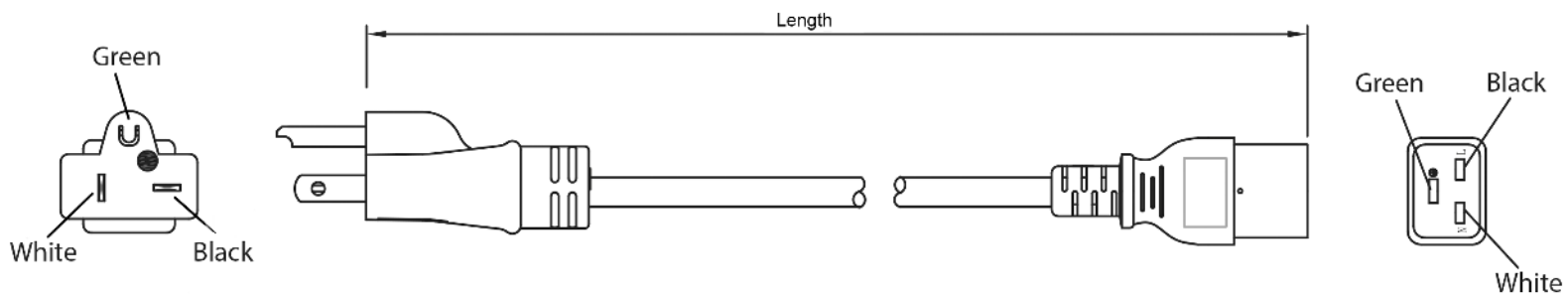







GlobTek, Inc. www.globtek.com 186 Veterans Drive, Northvale, NJ 07647 Tel. (201) 784-1000 Fax (201) 784-0111	Drawing Title: HOSPITAL GRADE WITH GREEN DOT, NEMA 6-20P MALE 2 PRONG PLUG WITH GROUND to NORTH AMERICAN IEC60320-C19 CONNECTOR, GT Cable #136: 12 / 3 Conductors, 10.8mm OD, SJT, 60 Deg.C, 300V, BLK/WHT/GRN, Approvals: , 5000±50mm, GlobTek Black	
	Model No. Power Cord	Rev A1
Part No./Ordering No. 360M13616F427032(R)		

CUSTOMIZED LENGTHS, COLORS, CABLE TYPES, TERMINATIONS/PLUGS/RECEPTACLES AVAILABLE UPON REQUEST. ADDITIONAL PLUG OPTIONS ARE AVAILABLE AT <https://www.globtek.com/connectors/> STANDARD PLUGS AND CONNECTORS CAN BE SEEN ONLINE AT <https://www.globtek.com/connectors/> ACTUAL CONNECTORS, OVERMOLDS, FERRITES MAY VARY SLIGHTLY FROM THE PICTURE BELOW DIMENSIONS ARE IN MM UNLESS SPECIFIED OTHERWISE

End A Code:360M Description:HOSPITAL GRADE WITH GREEN DOT, NEMA 6-20P MALE 2 PRONG PLUG WITH GROUND Rating (V):250 Rating (A):20.0 Gender:Male Overmolded:Yes	Cable Code:136 Description:GT Cable #136: 12 / 3 Conductors, 10.8mm OD, SJT, 60 Deg.C, 300V, BLK/WHT/GRN, Approvals: Color:GlobTek Black Wire Gauge(AWG):12 Cond:3 Type:SJT Temperature:60° C Amps:20 Volts:300 OD:10.8 ConductorsColors:BLK/WHT/GRN	End B Code:7032UL1 Description:NORTH AMERICAN IEC60320-C19 CONNECTOR Rating (V):250 Rating (A):20.0 Gender:Female Overmolded:Yes
---	---	--

Overall cable rating:125V 20A

Plug Approvals	Cable Approvals	Connector Approvals
 OR 	 OR 	 OR 
<p>Note: North American power cords are certified as assemblies of UL rated parts, so, the combination of UL certified plugs, connectors, and cables total up to a UL approved cordset or cable assembly</p> <p>LINK TO CERTs Link to live Power Cords listing @ UL Link to live Flexible Cord listing @ UL</p>	<p>Note: North American power cords are certified as UL CSA assemblies of UL rated parts, so, the combination of UL or certified plugs, connectors, and cables total up to a UL or CUL approved cordset or cable assembly</p> <p>LINK TO CERTs Link to live Power Cords listing @ UL Link to live Flexible Cord listing @ UL</p>	<p>Note: North American power cords are certified as UL CSA assemblies of UL rated parts, so, the combination of UL or certified plugs, connectors, and cables total up to a UL or CUL approved cordset or cable assembly</p> <p>LINK TO CERTs Link to live Power Cords listing @ UL Link to live Flexible Cord listing @ UL</p>

AGENCY ONLINE DOCUMENTS <http://en.globtek.com/cordsets/>

PROPRIETARY INFORMATION

PROPRIETARY OF GLOBTEK, INC. ANY REPRODUCTION, DISCLOSURE OR USE OF THIS DRAWING, IN WHOLE OR IN PART, IS HEREBY PROHIBITED EXCEPT AS SPECIFIED IN WRITING BY GLOBTEK, INC. © GlobTek, Inc.

2021 - 2023

quest /10/04/2023 8:02:48 PM CLONED FROM 360M1368F27032(R)

GlobTek, Inc. www.globtek.com 186 Veterans Drive, Northvale, NJ 07647 Tel. (201) 784-1000 Fax (201) 784-0111	Drawing Title: HOSPITAL GRADE WITH GREEN DOT, NEMA 6-20P MALE 2 PRONG PLUG WITH GROUND to NORTH AMERICAN IEC60320-C19 CONNECTOR, GT Cable #136: 12 / 3 Conductors, 10.8mm OD, SJT, 60 Deg.C, 300V, BLK/WHT/GRN, Approvals: , 5000±50mm, GlobTek Black	
	Model No. Power Cord	
	Part No./Ordering No. 360M13616F427032(R)	Rev A1

CUSTOMIZED LENGTHS, COLORS, CABLE TYPES, TERMINATIONS/PLUGS/RECEPTACLES AVAILABLE UPON REQUEST. ADDITIONAL PLUG OPTIONS ARE AVAILABLE AT <https://www.globtek.com/connectors/> STANDARD PLUGS AND CONNECTORS CAN BE SEEN ONLINE AT <https://www.globtek.com/connectors/> ACTUAL CONNECTORS, OVERMOLDS, FERRITES MAY VARY SLIGHTLY FROM THE PICTURE BELOW DIMENSIONS ARE IN MM UNLESS SPECIFIED OTHERWISE

RoHS/RoHS3 Declaration	https://www.globtek.com/pdf/rohs_cert/01t3a000005JwPEAA0
REACH Declaration	https://www.globtek.com/pdf/iso_certificates/REACH.pdf
Conflict Minerals Declaration	https://www.globtek.com/pdf/conflict-minerals.pdf
Prop 65 Statement	https://en.globtek.com/prop-65-statement.pdf
CE.UKCA.Cord	https://globtek.secure.force.com/spec/ec_decl_product_model_family_incl_cord?id=01t3a000005JwPE
IPXY rating is based on 3rd party testing and customers should check suitability and test system level IPXY rating before ordering.	

PROPRIETARY INFORMATION

PROPRIETARY OF GLOBTEK, INC. ANY REPRODUCTION, DISCLOSURE OR USE OF THIS DRAWING, IN WHOLE OR IN PART, IS HEREBY PROHIBITED EXCEPT AS SPECIFIED IN WRITING BY GLOBTEK, INC. © GlobTek, Inc. 2021 - 2023

quest /10/04/2023 8:02:48 PM CLONED FROM 360M1368F27032(R)

GlobTek, Inc. www.globtek.com 186 Veterans Drive, Northvale, NJ 07647 Tel. (201) 784-1000 Fax (201) 784-0111	Drawing Title: HOSPITAL GRADE WITH GREEN DOT, NEMA 6-20P MALE 2 PRONG PLUG WITH GROUND to NORTH AMERICAN IEC60320-C19 CONNECTOR, GT Cable #136: 12 / 3 Conductors, 10.8mm OD, SJT, 60 Deg.C, 300V, BLK/WHT/GRN, Approvals: , 5000±50mm, GlobTek Black
	Model No. Power Cord
	Part No./Ordering No. 360M13616F427032(R) Rev A1

CUSTOMIZED LENGTHS, COLORS, CABLE TYPES, TERMINATIONS/PLUGS/RECEPTACLES AVAILABLE UPON REQUEST. ADDITIONAL PLUG OPTIONS ARE AVAILABLE AT <https://www.globtek.com/connectors/> STANDARD PLUGS AND CONNECTORS CAN BE SEEN ONLINE AT <https://www.globtek.com/connectors/> ACTUAL CONNECTORS, OVERMOLDS, FERRITES MAY VARY SLIGHTLY FROM THE PICTURE BELOW DIMENSIONS ARE IN MM UNLESS SPECIFIED OTHERWISE

Hanking:360M-7032coiling
 Description:250±30 mm
 Image:

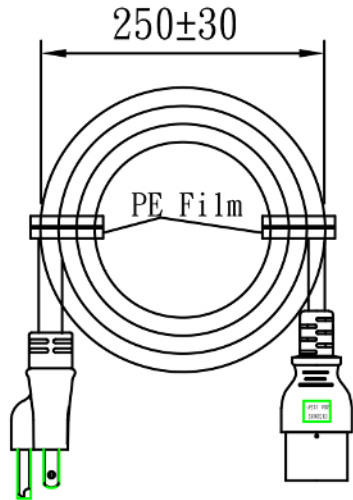

Notes/Modifications/Customizations (notes in this section supersede the values shown in the standard spec):