



# **GlobalTech Display**

*A Professional LCD Displays Provider*

## **TFT LCD Display Specification**

**PN: GLT1011280800IS1-CTP**

### Overview:

- 10.1" Diagonal
- IPS, Full View Angle
- Driver: EK79202
- 16.7M Colors
- 1000 Nits
- 1280 x 800 Pixels
- Transmissive/Normally Black
- LVDS Interface
- CTP with Gorilla Glass
- RoHS Compliant

9825 Widmer Road, Lenexa, KS 66215, USA | Tel: 913-828-5685 Fax: 913-273-4397

Email: [sales@gtdisplays.com](mailto:sales@gtdisplays.com) Website: [www.gtdisplays.com](http://www.gtdisplays.com)

# Table of Contents

1. Record of Revision.....	2
2. General Specifications.....	3
3. Input / Output Interface.....	4
4. Absolute Maximum Rating.....	5
5. Electrical Characteristics.....	6
6. Optical Characteristics.....	11
7. Environmental / Reliability Tests.....	14
8. Mechanical Drawing.....	15
9. Packing.....	16
10. TFT-LCD Module Inspection Criteria.....	17
11. Precautions for Use of LCD modules.....	21

# 1. Record of Revision

<b>Rev</b>	<b>Issued Date</b>	<b>Description</b>	<b>Editor</b>
1.0	2021/04/01	First Release	ZWF

## 2. General Specifications

Feature		Spec
Characteristics	Size	10.1 inch
	Resolution	1280(Horizontal) x 800(Vertical)
	Interface	LVDS
	Connect type	Connector
	Color Depth	16.7M
	Technology type	a-Si
	Display Spec. Pixel pitch (mm)	0.1695(H) x 0.1695(V)
	Pixel Configuration	R.G.B. Vertical Stripe
	Display Mode	Normally Black
	Driver IC	EK79202
	Touch Driver IC	ILI2511
	Viewing Direction	ALL
Mechanical	LCM (W x H x D) (mm)	249.96(W) x 168.60(H) x 6.33 (D)
	Active Area(mm)	216.96(H) x 135.60(V)
	With /Without TP	With CTP
	Weight (g)	~420g
	LED Numbers	45 LEDs

Note 1: Requirements on Environmental Protection: RoHS

Note 2: LCM weight tolerance: +/- 5%

### 3. Input / Output Interface

#### LCD PIN-MAP

No.	Symbol	Description	Note
1	VCOM(-0.65V)	Common voltage	
2-3	VDD (3.3V)	Power Supply	
4	NC	No connection	
5	RESET	Reset Pin for LCM	
6	STBYB	Standby mode, normally pull high STBYB="1", normal operation STBYB="0", source driver will turn off, all output are high-Z	
7	GND	Ground	
8	RXIN0-	- LVDS differential data input	
9	RXIN0+	+ LVDS differential data input	
10	GND	Ground	
11	RXIN1-	- LVDS differential data input	
12	RXIN1+	+ LVDS differential data input	
13	GND	Ground	
14	RXIN2-	- LVDS differential data input	
15	RXIN2+	+ LVDS differential data input	
16	GND	Ground	
17	RXCLK-	- LVDS differential clock input	
18	RXCLK+	+ LVDS differential clock input	
19	GND	Ground	
20	RXIN3-	- LVDS differential data input	
21	RXIN3+	+ LVDS differential data input	
22	GND	Ground	
23-24	NC	No connection	
25	GND	Ground	
26	NC	No connection	
27	LVBIT	6bit/8bit mode select	Note 1
28	NC	No connection	
29	VSP(5.5V)	Input voltage from the set-up circuit (5.5V).	
30	NC	No connection	
31-32	LEDK	Power for LED backlight (Cathode)	

33	NC	No connection	
34	VSN(-5.5V)	Input voltage from the set-up circuit (-5.5V).	
35	NC	No connection	
36	VGL(-10V)	Gate OFF Voltage	
37	NC	No connection	
38	VGH(18V)	Gate ON Voltage	
39-40	LEDA	Power for LED backlight (Anode)	

Note 1: If LVDS input data is 8bit, LVBIT must be set to high.

If LVDS input data is 6bit, LVBIT must be set to low.

## CTP PIN-MAP

Pin	Signal	Description
1	GND	Ground
2	VDD	Power supply
3	SDA	I2C data input and output
4	SCL	I2C clock input
5	/RST	Reset Pin for CTP
6	/INT	Interrupt request to the host
7	NC	No connection
8	GND	Ground

## 4. Absolute Maximum Ratings

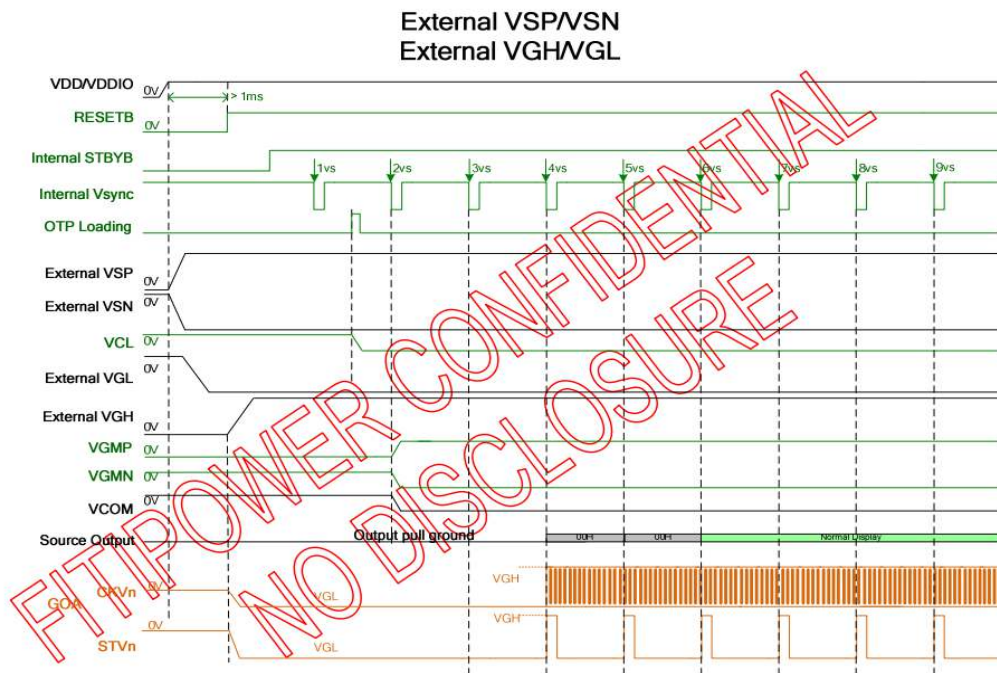
Item	Symbol	MIN	Typ	MAX	Unit	Remark
Supply Voltage	VDD	-0.3	-	5.0	V	-
Operating Temperature	TOPR	-20	-	70	°C	-
Storage Temperature	TSTG	-30	-	80	°C	

## 5. Electrical Characteristics

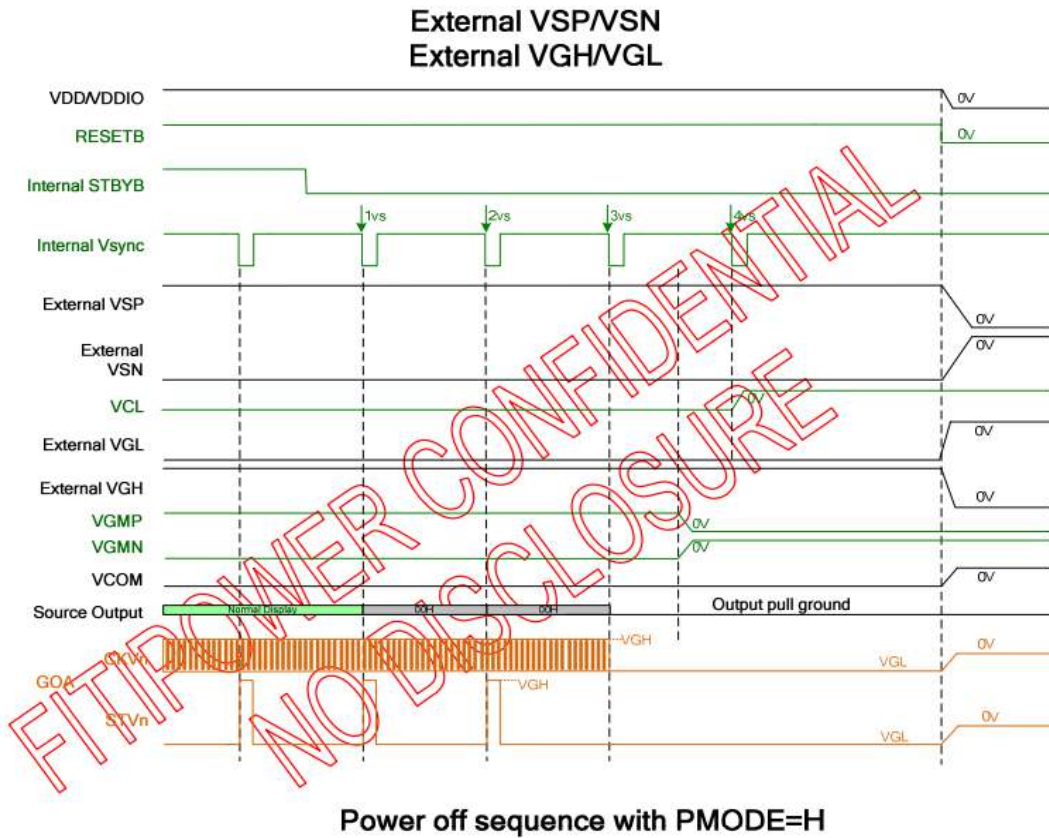
### 5.1 Driving TFT LCD Panel

Item	Symbol	MIN	TYP	MAX	Unit	Remark
Power voltage	VDD	3.0	3.3	3.6	V	
	VGH	16	18.0	20	V	
	VGL	-11	-10	-8	V	
	VSN	-6.0	-5.5	-4.5		
	VSP	4.5	5.5	6.0		
Input signal voltage	VCOM	-1.5	-0.65	-0.5	V	

### 5.2 Power ON/OFF Sequence



Power on sequence with PMODE=H



### 5.3 Driving Backlight

Item	Symbol	MIN	TYP	MAX	Unit	Remark
Forward Current	$I_F$	-	450	-	mA	
Forward Voltage	$V_F$	13.5V	16V	17V	V	
Backlight Power consumption	$W_{BL}$	-	7.2	-	W	
LED Lifetime		-	50000	-	Hour	

Note 1: Each LED:  $I_F = 50 \text{ mA}$ ,  $V_F = 2.8 \sim 3.4 \text{ V}$ .

Note 2: Optical performance should be evaluated at  $T_a = 25^\circ \text{C}$  only.

Note 3: If LED is driven by high current, high ambient temperature & humidity condition. The life Time of LED will be reduced. Operating life means brightness goes down to 50% initial brightness. Typical operating life time is estimated data.



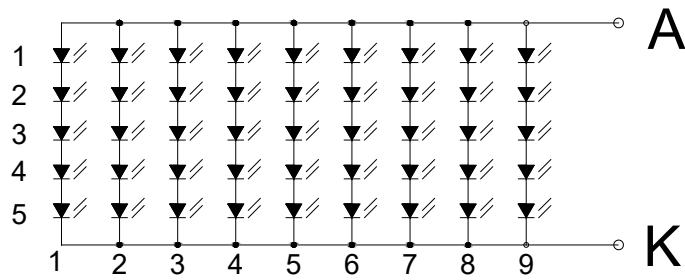


Figure: LED connection of backlight (Constant Current)

### 5.4 Reset Timing Characteristics

When RESETB of the reset pin equals to Low, it will be in the condition of reset. When it is in the condition of reset, it will make the device recover the initial set.

However, in order to avoid the reset noise cause reset, there is a mechanism to judge about whether the reset is needed or not.

The closed interval of Low can be shown as the following.

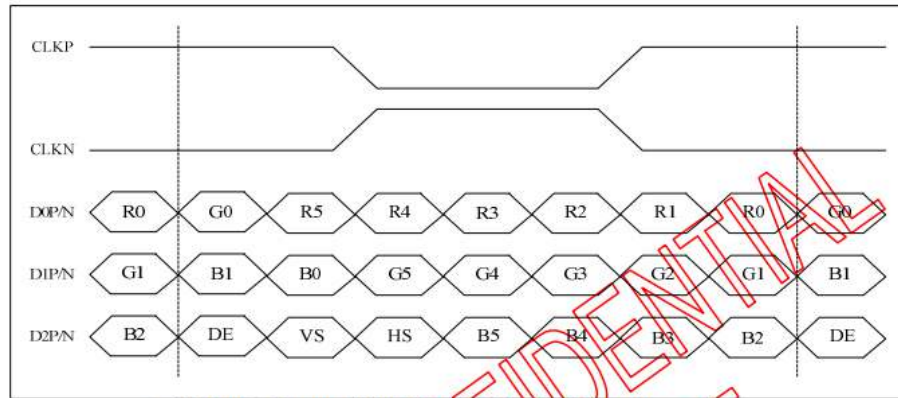
(Test condition: VDDIO=2.3V~3.6V, VSS=0V, TA=-20 ~+85 )

Parameter	Symbol	Conditions	Spec.			Unit
			Min.	Typ.	Max	
Reset low pulse width	Trst		20	-	-	μs

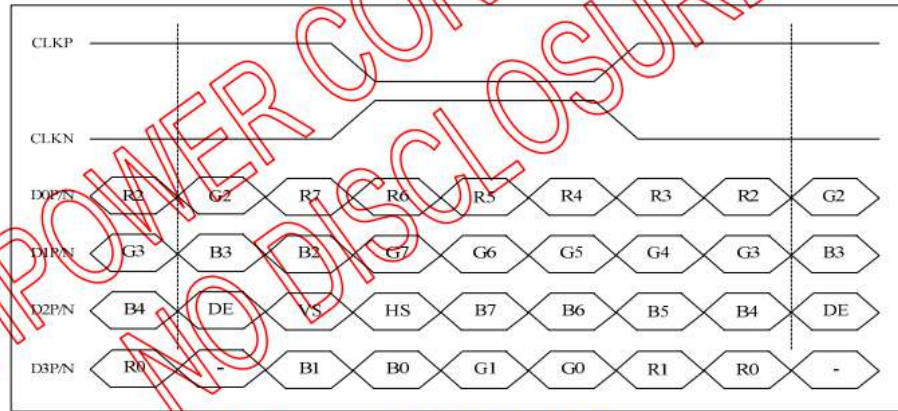


Figure 13.5: Reset timing

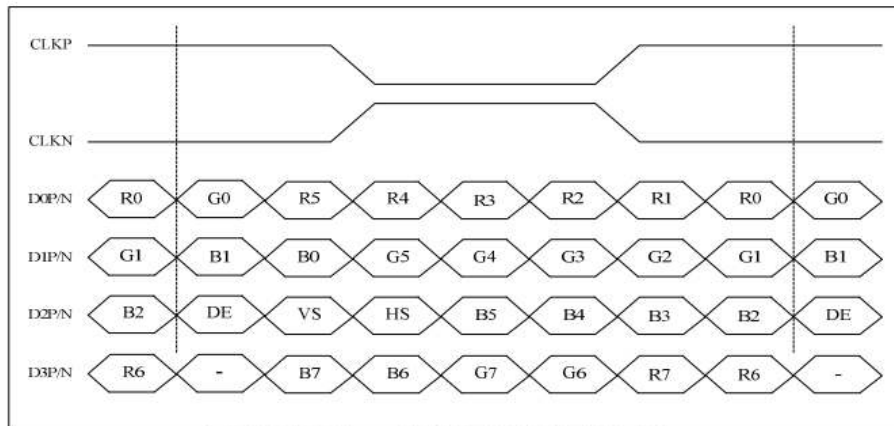
## 5.5 LVDS interface Characteristics



6-bit LVDS input (LVBIT=L, LVFMT=Don't care)



8-bit LVDS input (LVBIT=H, LVFMT=L)



8-bit LVDS input(LVBIT=H, LVFMT=H)

For 1280RGBx800

Parameter	Symbol	Value			Unit
		Min.	Typ.	Max.	
DCLK frequency @Frame rate=60Hz (LVDS)	F <sub>DCLK</sub>	66.3	72.4	78.9	MHz
HSYNC period time	T <sub>H</sub>	1380	1440	1500	DCLK
Horizontal display area	T <sub>HD</sub>	1280			DCLK
HSYNC pulse width	Min.	1			
	Typ.	-			
	Max.	40			
HSYNC back porch(with pulse width)	T <sub>HBP</sub>	88	88	88	DCLK
HSYNC front porch	T <sub>HFP</sub>	12	72	132	DCLK
VSYNC period time	T <sub>V</sub>	824	838	872	H
Vertical display area	T <sub>VD</sub>	800			H
VSYNC pulse width	Min.	1			H
	Typ.	-			
	Max.	20			
VSYNC back porch(with pulse width)	T <sub>VBP</sub>	23	23	23	H
VSYNC front porch	T <sub>VFP</sub>	1	15	49	H

## 6. Optical Characteristics

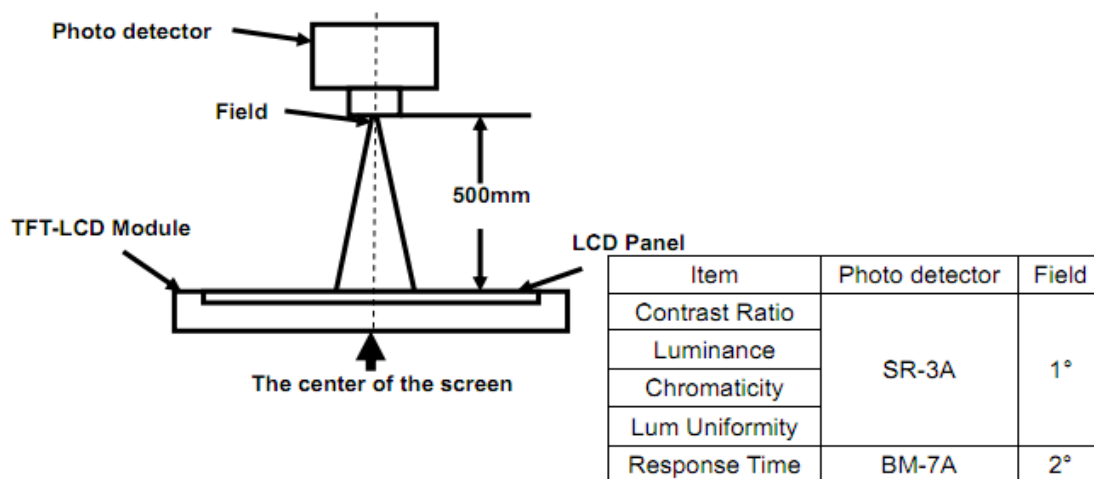
Items		Symbol	Condition	Min.	Typ.	Max.	Unit	Remark
Viewing angles		$\theta_T$	Center CR $\geq$ 10		80	-	Degree.	Note2
		$\theta_B$			80	-		
		$\theta_L$			80	-		
		$\theta_R$			80	-		
Contrast Ratio		CR	$\theta = 0$	800	1000	-	-	Note1 Note3
Response Time		$T_{ON}$	25°C	-	25	35	ms	Note1
		$T_{OFF}$		Note4				
Chromaticity	White	$X_W$	Backlight is on	-	0.322	-	-	Note1
		$Y_W$		-	0.344	-	-	Note5
Luminance Uniformity		LU		70	75	-	%	Note1 Note6
Luminance		LUM		850	1000		cd/m2	Note1 Note7

Test Conditions:

1. IF= 30mA (one channel), the ambient temperature is 25°C.
2. The test systems refer to Note 1 and Note 2.

Note 1: Definition of optical measurement system.

The optical characteristics should be measured in dark room. After 5 minutes operation, the optical properties are measured at the center point of the LCD screen. All input terminals LCD panel must be ground when measuring the center area of the panel.



Note 2: Definition of viewing angle range and measurement system.

Viewing angle is measured at the center point of the LCD by CONOSCOPE (ergo-80).

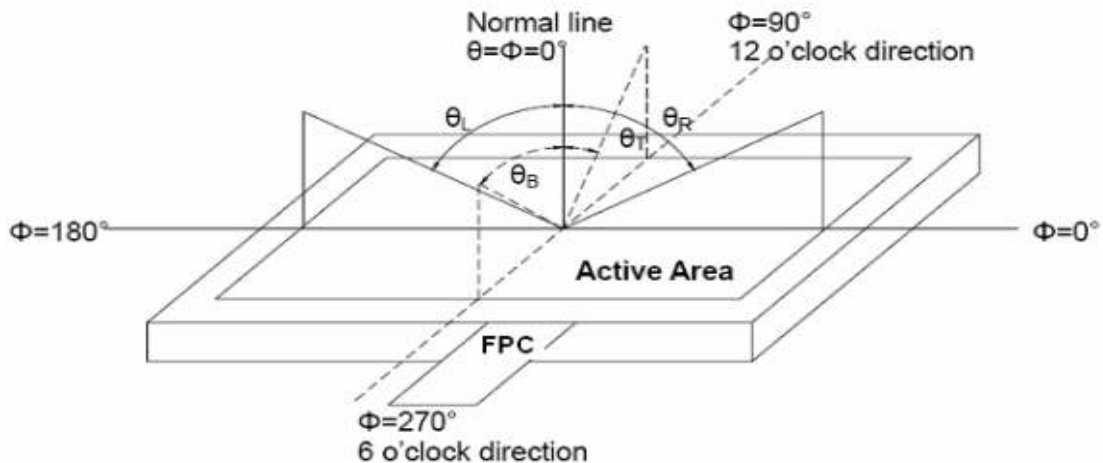


Fig. 1 Definition of viewing angle

Note 3: Definition of contrast ratio

$$\text{Contrast ratio (CR)} = \frac{\text{Luminance measured when LCD on the "White"}}{\text{Luminance measured when LCD on the "Black"}}$$

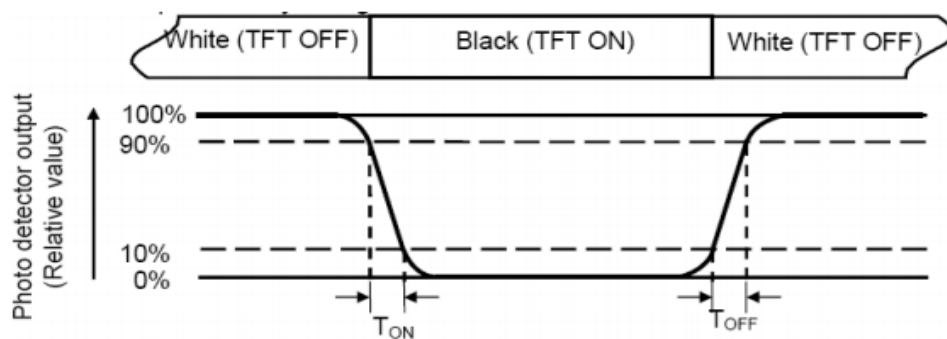
“White state”: The state is that the LCD should be driven by  $V_{\text{white}}$ .

“Black state”: The state is that the LCD should be driven by  $V_{\text{black}}$ .

$V_{\text{white}}$ : To be determined,  $V_{\text{black}}$ : To be determined.

Note 4: Definition of Response time

The response time is defined as the LCD optical switching time interval between “White” state and “Black” state. Rise time ( $T_{\text{ON}}$ ) is the time between photo detector output intensity changed from 90% to 10%. And fall time ( $T_{\text{OFF}}$ ) is the time between photo detector output intensity changed from 10% to 90%.



Note 5: Definition of color chromaticity (CIE1931)  
Color coordinates measured at center point of LCD.

Note 6: Definition of Luminance Uniformity

Active area is divided into 9 measuring areas (Refer Fig. 2). Every measuring point is placed at the center of each measuring area.

$$\text{Luminance Uniformity (U)} = \text{Lmin} / \text{Lmax} \times 100\%$$

L: Active area length, W: Active area width

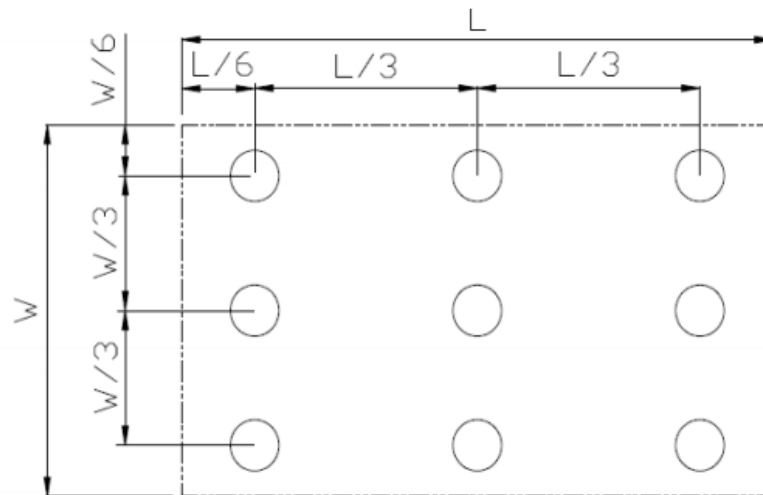


Fig. 2 Definition of uniformity

$L_{max}$ : The measured maximum luminance of all measurement position.

$L_{min}$ : The measured minimum luminance of all measurement position.

Note 7: Definition of Luminance:

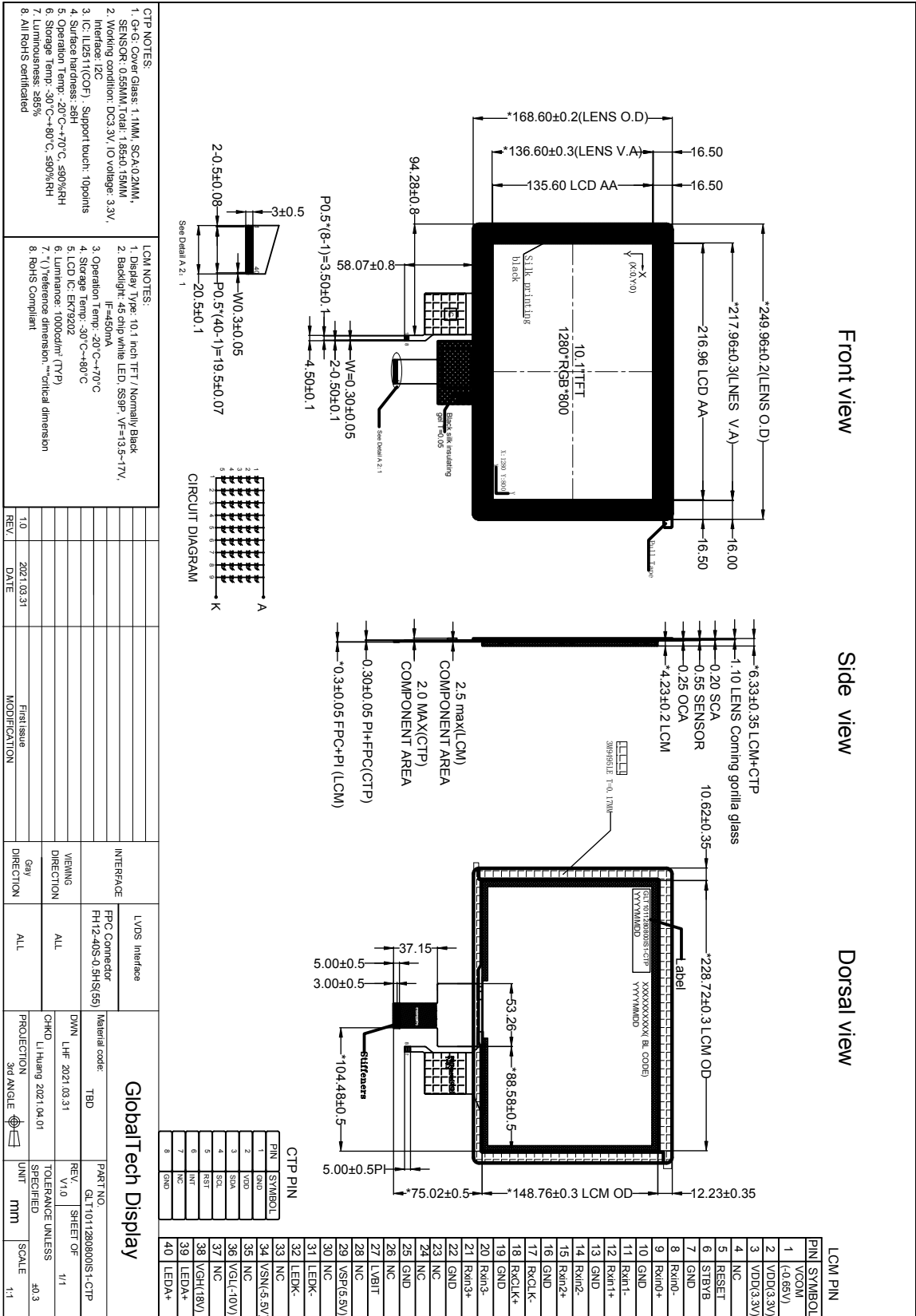
Measure the luminance of white state at center point.

## 7. Environmental / Reliability Tests

No	Test Item	Condition	Remarks
1	High Temperature Operation	T <sub>s</sub> = +70°C, 96hrs	Note 1 IEC60068-2-2, GB2423.2-89
2	Low Temperature Operation	T <sub>a</sub> = -20°C, 96hrs	Note 2 IEC60068-2-1 GB2423.1-89
3	High Temperature Storage	T <sub>a</sub> = +80°C, 96hrs	IEC60068-2-2 GB2423.2-89
4	Low Temperature Storage	T <sub>a</sub> = -30°C, 96hrs	IEC60068-2-1 GB/T2423.1-89
5	High Temperature & Humidity Storage	T <sub>a</sub> = +60°C, 90% RH max, 96 hours	IEC60068-2-3 GB/T2423.3-2006
6	Thermal Shock (Non-operation)	-30°C 30 min ~ +80°C 30 min Change time: 5min, 30 Cycle	Start with cold temperature, end with high temperature IEC60068-2-14, GB2423.22-87
7	Electro Static Discharge (Operation)	C=150pF, R=330 Ω, 5 points/panel Air:±8KV, 5 times; Contact: ±4KV, 5 times; (Environment: 15°C ~ 35°C, 30% ~ 60%, 86Kpa ~ 106Kpa)	IEC61000-4-2 GB/T17626.2-1998
8	Vibration (Non-operation)	Frequency range: 1~55Hz, Stroke: 1.mm, Sweep: 1Hz~55Hz~3.5Hz 2 hours for each direction of X . Y . Z. (package condition)	IEC60068-2-6 GB/T2423.5-1995
10	Package Drop Test	Height: 80 cm, 1 corner, 3 edges, 6 surfaces	IEC60068-2-32 GB/T2423.8-1995

Note: 1. T<sub>s</sub> is the temperature of panel's surface.  
2. T<sub>a</sub> is the ambient temperature of sample.

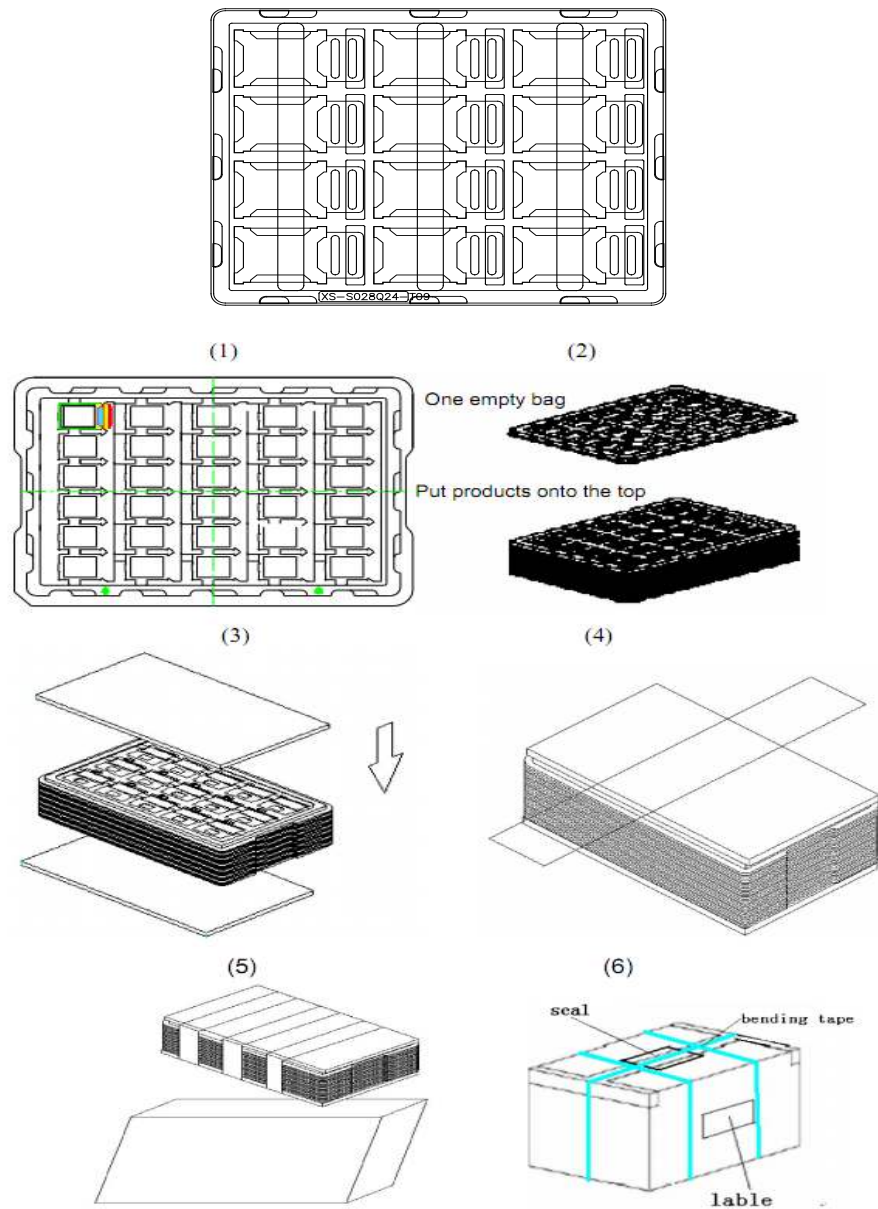
# 8 Mechanical Drawing





## 9. Packing

### Packing Method



1. Put module into tray cavity.
2. Tray stacking.
3. Put 1 cardboard under the tray stack and 1 cardboard above.
4. Fix the cardboard to the tray stack with adhesive tape.
5. Put the tray stack into carton.
6. Carton sealing with adhesive tape.

## 10. TFT-LCD Module Inspection Criteria

### 10.1 Scope

The incoming inspection standards shall be applied to TFT-LCD Modules (hereinafter Called "Modules") that supplied by GlobalTech Display.

### 10.2 Incoming Inspection

The customer shall inspect the modules within twenty calendar days of the delivery date (the inspection period) at its own cost. The result of the inspection (acceptance or rejection) shall be recorded in writing, and a copy of this writing will be promptly sent to the seller, If the results of the inspecting from buyer does not send to the seller within twenty calendar days of the delivery date. The modules shall be regards as acceptance. Should the customer fail to notify the seller within the inspection period, the buyer's right to reject the modules shall be lapsed and the modules shall be deemed to have been accepted by the buyer

### 10.3 Inspection Sampling

10.3.1. Lot size: Quantity per shipment lot per model

10.3.2. Sampling type: Normal inspection, Single sampling

10.3.3. Inspection level: II

10.3.4. Sampling table: MIL-STD-105E

10.3.5. Acceptable quality level (AQL )

Major defect: AQL=0.65 Minor defect: AQL=1.00

### 10.4 Inspection Conditions

10.4.1 Ambient conditions:

a. Temperature: Room temperature  $25 \pm 5^{\circ}\text{C}$

b. Humidity:  $(60 \pm 10) \% \text{RH}$

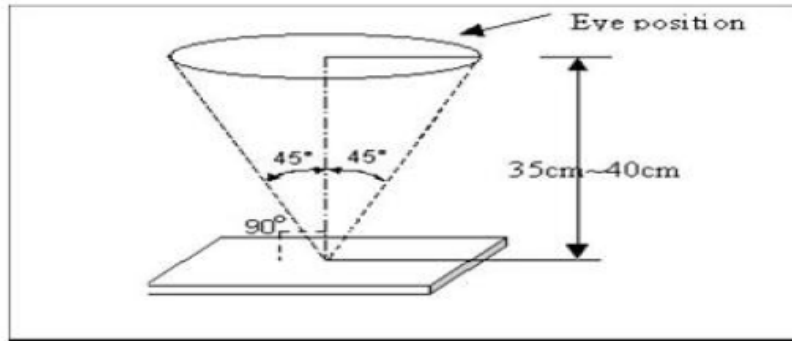
c. Illumination: Single fluorescent lamp non-directive (300 to 700 Lux)

10.4.2 Viewing distance

The distance between the LCD and the inspector's eyes shall be at least  $35 \pm 5\text{cm}$ .

10.4.3 Viewing Angle

U/D:  $45^{\circ} / 45^{\circ}$  , L/R:  $45^{\circ} / 45^{\circ}$



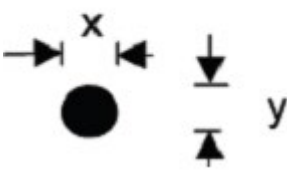
### 10.5 Inspection Criteria

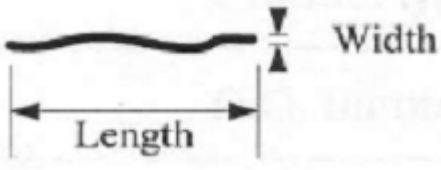

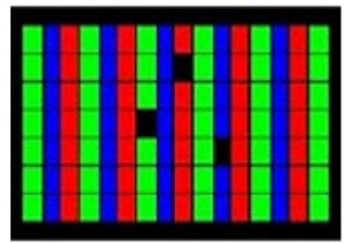
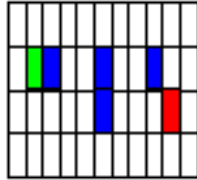
Defects are classified as major defects and minor defects according to the degree of defectiveness defined herein.

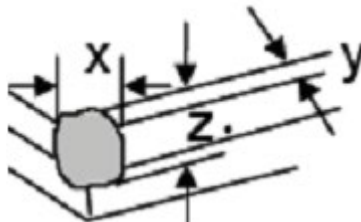
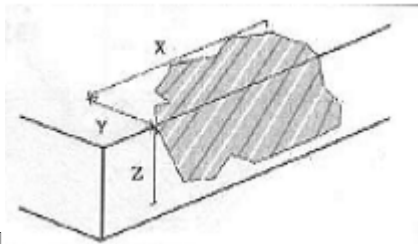
#### 10.5.1 Major defect

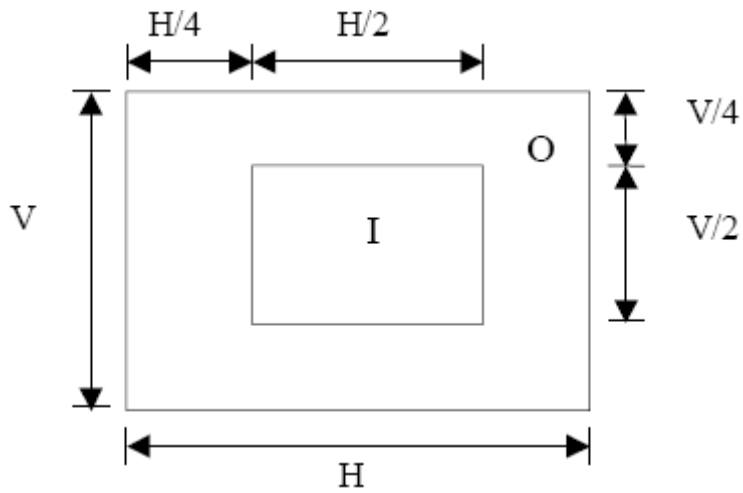
Item No	Items to be inspected	Inspection Standard
10.5.1.1	All functional defects	1) No display 2) Display abnormally 3) Short circuit 4) line defect
10.5.1.2	Missing	Missing function component
10.5.1.3	Crack	Glass Crack

#### 10.5.2 Minor defect

Item No	Items to be inspected	Inspection standard	
10.5.2.1	Spot Defect Including Black spot White spot Pinhole Foreign particle Polarizer dirt	For dark/white spot is defined $\phi = (x+y) / 2$ 	
		Size $\phi$ (mm)	Acceptable Quantity
		$\phi \leq 0.2$	Ignore
		$0.2 < \phi \leq 0.5$	3
		$0.5 < \phi$	Not allowed

10.5.2.2	Line Defect Including Black line White line Scratch	Define: 			
		Width(mm) Length(mm)		Acceptable Quantity	
		$W \leq 0.03$		Ignore	
		$0.03 < W \leq 0.04$ $L \leq 5.0$		4	
		$0.04 < W$ , or $L > 5.0$		Not allowed	
10.5.2.3	Polarizer Dent/Bubble	Size $\phi$ (mm)		Acceptable Quantity	
		$\phi \leq 0.25$		Ignore	
		$0.25 < \phi \leq 0.5$		3	
		$0.5 < \phi$		Not allowed	
		Total QTY		3	
10.5.2.4	Electrical Dot Defect	Bright and Black dot define:   and 			
		Two Adjacent Dot			
		Inspection pattern: Full white, Full black, Red, green and blue screens			
		Item	Acceptable Quantity		
			I	O	Total
		Black dot defect	2	3	4
		Bright dot defect	0	3	3
Total Dot	2	4	5		
3% Bright Dot is allowed					

10.5.2.5	Glass defect	 <p><b>1. Corner Fragment:</b></p>	
		<b>Size(mm)</b>	<b>Acceptable Quantity</b> ☐
		$X \leq 3\text{mm}$ $Y \leq 1\text{mm}$ $Z \leq T$	<b>Ignore</b> <b>T: Glass thickness</b> <b>X: Length</b> <b>Y: Width</b> <b>Z: thickness</b>
		 <p><b>2. Side Fragment:</b> ☐</p>	
		<b>Size(mm)</b>	<b>Acceptable Quantity</b>
		$X \leq 5.0\text{mm}$ $Y \leq 1\text{mm}$ $Z \leq T$	<b>T: Glass thickness</b> <b>X: Length</b> <b>Y: Width</b> <b>Z: thickness</b>



I area & O area

- Note:
- 1). Dot defect is defined as the defective area of the dot area is larger than 50% of the dot area.
  - 2). The distance between two bright dot defects (red, green, blue, and white) should be larger than 15mm.
  - 3). The distance between black dot defects or black and bright dot defects should be more than 5mm apart.
  - 4). Polarizer bubble is defined as the bubble appears on active display area. The defect of polarizer bubble shall be ignored if the polarizer bubble appears on the outside of active display area.

## 10.6 Mechanics specification

As for the outside dimension, weight of the modules, please refer to product specification  
For more details

# 11. Precautions for Use of LCD modules

## 11.1 Handling Precautions

11.1.1. The display panel is made of glass. Do not subject it to a mechanical shock by dropping it from a high place, etc.

11.1.2. If the display panel is damaged and the liquid crystal substance inside it leaks out, be sure not to get any in your mouth, if the substance comes into contact with your skin or clothes, promptly wash it off using soap and water.

11.1.3. Do not apply excessive force to the display surface or the adjoining areas since this may cause the color tone to vary.

11.1.4. The polarizer covering the display surface of the LCD module is soft and easily scratched. Handle this polarizer carefully.

11.1.5. If the display surface is contaminated, breathe on the surface and gently wipe it with a soft dry cloth. If still not completely clear, moisten cloth with one of the following solvents:

- Isopropyl alcohol
- Ethyl alcohol

Solvents other than those mentioned above may damage the polarizer. Especially, do not use the following:

- Water
- Ketene

11.1.6. Do not attempt to disassemble the LCD Module.

11.1.7. If the logic circuit power is off, do not apply the input signals.

11.1.8. To prevent destruction of the elements by static electricity, be careful to maintain an optimum work environment.

11.1.8.1. Be sure to ground the body when handling the LCD Modules.

11.1.8.2. Tools required for assembly, such as soldering irons, must be properly ground.

11.1.8.3. To reduce the amount of static electricity generated, do not conduct assembly and other work under dry conditions.

11.1.8.4. The LCD Module is coated with a film to protect the display surface. Be care when peeling off this protective film since static electricity may be generated.

## **11.2 Storage Precautions**

11.2.1. When storing the LCD modules, avoid exposure to direct sunlight or to the light of fluorescent lamps.

11.2.2. The LCD modules should be stored under the storage temperature range. If the LCD modules will be stored for a long time, the recommended condition is:

Temperature: 0°C ~ 40°C, Relatively humidity: ≤80%

11.2.3. The LCD modules should be stored in the room without acid, alkali and harmful gas.

## **11.3 Transportation Precautions**

The LCD modules should be no falling and violent shocking during transportation, and also should avoid excessive press, water, damp and sunshine.