

## N-Channel MOSFET

Power MOS 8™ is a high speed, high voltage N-channel switch-mode power MOSFET. A proprietary planar stripe design yields excellent reliability and manufacturability. Low switching loss is achieved with low input capacitance and ultra low  $C_{rss}$  "Miller" capacitance. The intrinsic gate resistance and capacitance of the poly-silicon gate structure help control slew rates during switching, resulting in low EMI and reliable paralleling, even when switching at very high frequency. Reliability in flyback, boost, forward, and other circuits is enhanced by the high avalanche energy capability.

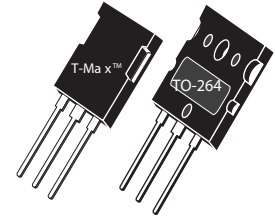

APT28M120B2

APT28M120L

Single die MOSFET

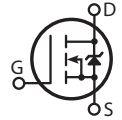

### FEATURES

- Fast switching with low EMI/RFI
- Low  $R_{DS(on)}$
- Ultra low  $C_{rss}$  for improved noise immunity
- Low gate charge
- Avalanche energy rated
- RoHS compliant 

### TYPICAL APPLICATIONS

- PFC and other boost converter
- Buck converter
- Two switch forward (asymmetrical bridge)
- Single switch forward
- Flyback
- Inverters

### Absolute Maximum Ratings

Symbol	Parameter	Ratings	Unit
$I_D$	Continuous Drain Current @ $T_C = 25^\circ\text{C}$	29	A
	Continuous Drain Current @ $T_C = 100^\circ\text{C}$	18	
$I_{DM}$	Pulsed Drain Current <sup>①</sup>	104	
$V_{GS}$	Gate-Source Voltage	±30	V
$E_{AS}$	Single Pulse Avalanche Energy <sup>②</sup>	2165	mJ
$I_{AR}$	Avalanche Current, Repetitive or Non-Repetitive	14	A

### Thermal and Mechanical Characteristics

Symbol	Characteristic	Min	Typ	Max	Unit
$P_D$	Total Power Dissipation @ $T_C = 25^\circ\text{C}$			1135	W
$R_{\theta JC}$	Junction to Case Thermal Resistance			0.11	$^\circ\text{C/W}$
$R_{\theta CS}$	Case to Sink Thermal Resistance, Flat, Greased Surface		0.11		
$T_J, T_{STG}$	Operating and Storage Junction Temperature Range	-55		150	$^\circ\text{C}$
$T_L$	Soldering Temperature for 10 Seconds (1.6mm from case)			300	
$W_T$	Package Weight		0.22		oz
			6.2		g
Torque	Mounting Torque ( TO-264 Package), 4-40 or M3 screw			10	in·lbf
				1.1	N·m

**Static Characteristics**
**T<sub>J</sub> = 25°C unless otherwise specified**
**APT28M120B2\_L**

Symbol	Parameter	Test Conditions	Min	Typ	Max	Unit
V <sub>BR(DSS)</sub>	Drain-Source Breakdown Voltage	V <sub>GS</sub> = 0V, I <sub>D</sub> = 250μA	1200			V
ΔV <sub>BR(DSS)</sub> /ΔT <sub>J</sub>	Breakdown Voltage Temperature Coefficient	Reference to 25°C, I <sub>D</sub> = 250μA		1.41		V/°C
R <sub>DS(on)</sub>	Drain-Source On Resistance <sup>③</sup>	V <sub>GS</sub> = 10V, I <sub>D</sub> = 14A		0.45	0.53	Ω
V <sub>GS(th)</sub>	Gate-Source Threshold Voltage	V <sub>GS</sub> = V <sub>DS</sub> , I <sub>D</sub> = 2.5mA	3	4	5	V
ΔV <sub>GS(th)</sub> /ΔT <sub>J</sub>	Threshold Voltage Temperature Coefficient			-10		mV/°C
I <sub>DSS</sub>	Zero Gate Voltage Drain Current	V <sub>DS</sub> = 1200V V <sub>GS</sub> = 0V			100	μA
		T <sub>J</sub> = 25°C			500	
		T <sub>J</sub> = 125°C				
I <sub>GSS</sub>	Gate-Source Leakage Current	V <sub>GS</sub> = ±30V			±100	nA

**Dynamic Characteristics**
**T<sub>J</sub> = 25°C unless otherwise specified**

Symbol	Parameter	Test Conditions	Min	Typ	Max	Unit
g <sub>fs</sub>	Forward Transconductance	V <sub>DS</sub> = 50V, I <sub>D</sub> = 14A		31		S
C <sub>iss</sub>	Input Capacitance	V <sub>GS</sub> = 0V, V <sub>DS</sub> = 25V f = 1MHz		9670		pF
C <sub>rss</sub>	Reverse Transfer Capacitance			115		
C <sub>oss</sub>	Output Capacitance			715		
C <sub>o(cr)</sub> <sup>④</sup>	Effective Output Capacitance, Charge Related	V <sub>GS</sub> = 0V, V <sub>DS</sub> = 0V to 800V		275		pF
C <sub>o(er)</sub> <sup>⑤</sup>	Effective Output Capacitance, Energy Related			140		
Q <sub>g</sub>	Total Gate Charge	V <sub>GS</sub> = 0 to 10V, I <sub>D</sub> = 14A, V <sub>DS</sub> = 600V		300		nC
Q <sub>gs</sub>	Gate-Source Charge			50		
Q <sub>gd</sub>	Gate-Drain Charge			140		
t <sub>d(on)</sub>	Turn-On Delay Time	<b>Resistive Switching</b> V <sub>DD</sub> = 800V, I <sub>D</sub> = 14A R <sub>G</sub> = 2.2Ω <sup>⑥</sup> , V <sub>GG</sub> = 15V		50		ns
t <sub>r</sub>	Current Rise Time			31		
t <sub>d(off)</sub>	Turn-Off Delay Time			170		
t <sub>f</sub>	Current Fall Time			48		

**Source-Drain Diode Characteristics**

Symbol	Parameter	Test Conditions	Min	Typ	Max	Unit
I <sub>S</sub>	Continuous Source Current (Body Diode)	MOSFET symbol showing the integral reverse p-n junction diode (body diode)			29	A
I <sub>SM</sub>	Pulsed Source Current (Body Diode) <sup>①</sup>				104	
V <sub>SD</sub>	Diode Forward Voltage	I <sub>SD</sub> = 14A, T <sub>J</sub> = 25°C, V <sub>GS</sub> = 0V			1	V
t <sub>rr</sub>	Reverse Recovery Time	I <sub>SD</sub> = 14A <sup>②</sup>		1290		ns
Q <sub>rr</sub>	Reverse Recovery Charge	di <sub>SD</sub> /dt = 100A/μs, T <sub>J</sub> = 25°C		33		μC
dv/dt	Peak Recovery dv/dt	I <sub>SD</sub> ≤ 14A, di/dt ≤ 1000A/μs, V <sub>DD</sub> = 100V, T <sub>J</sub> = 125°C			10	V/ns

① Repetitive Rating: Pulse width and case temperature limited by maximum junction temperature.

② Starting at T<sub>J</sub> = 25°C, L = 22.09mH, R<sub>G</sub> = 2.2Ω, I<sub>AS</sub> = 14A.

③ Pulse test: Pulse Width < 380μs, duty cycle < 2%.

④ C<sub>o(cr)</sub> is defined as a fixed capacitance with the same stored charge as C<sub>OSS</sub> with V<sub>DS</sub> = 67% of V<sub>(BR)DSS</sub>.

⑤ C<sub>o(er)</sub> is defined as a fixed capacitance with the same stored energy as C<sub>OSS</sub> with V<sub>DS</sub> = 67% of V<sub>(BR)DSS</sub>. To calculate C<sub>o(er)</sub> for any value of V<sub>DS</sub> less than V<sub>(BR)DSS</sub>, use this equation: C<sub>o(er)</sub> = -4.40E-7/V<sub>DS</sub><sup>2</sup> + 5.34E-8/V<sub>DS</sub> + 7.59E-11.

⑥ R<sub>G</sub> is external gate resistance, not including internal gate resistance or gate driver impedance. (MIC4452)

Microsemi reserves the right to change, without notice, the specifications and information contained herein.

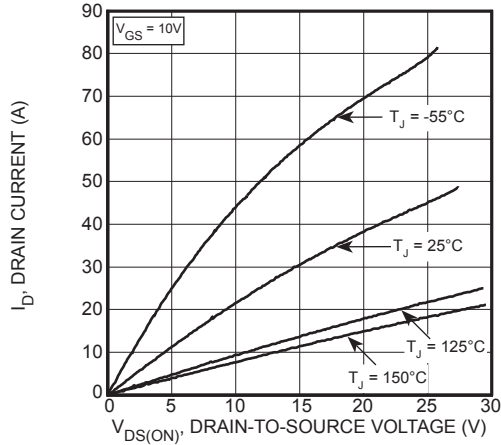

Figure 1, Output Characteristics

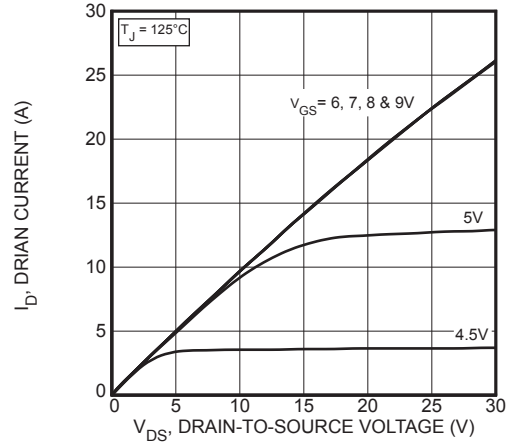

Figure 2, Output Characteristics

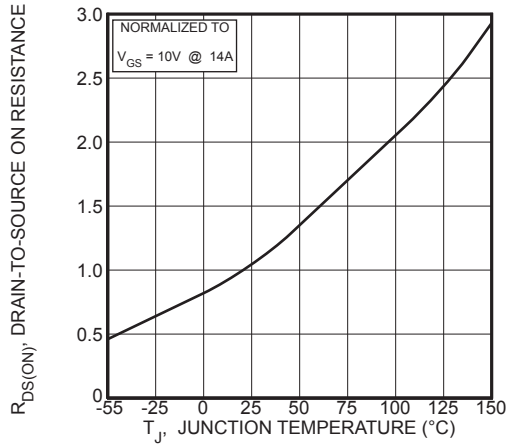

Figure 3,  $R_{DS(ON)}$  vs Junction Temperature

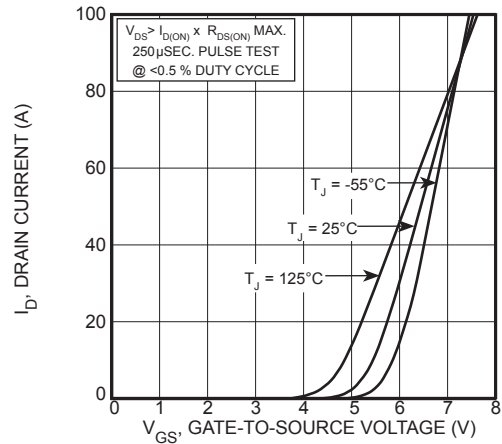

Figure 4, Transfer Characteristics

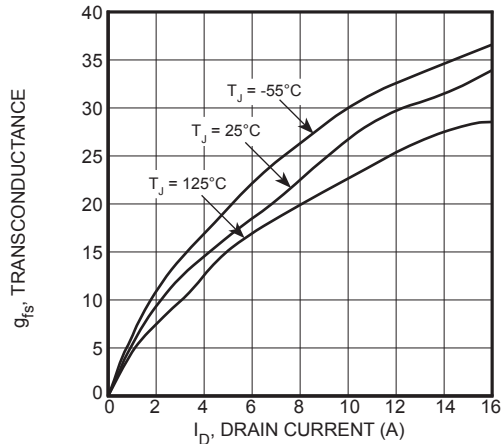

Figure 5, Gain vs Drain Current

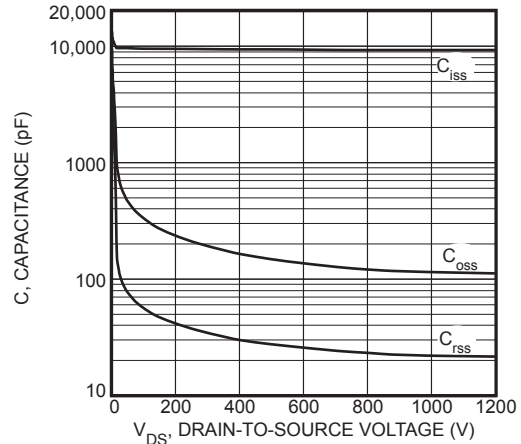

Figure 6, Capacitance vs Drain-to-Source Voltage

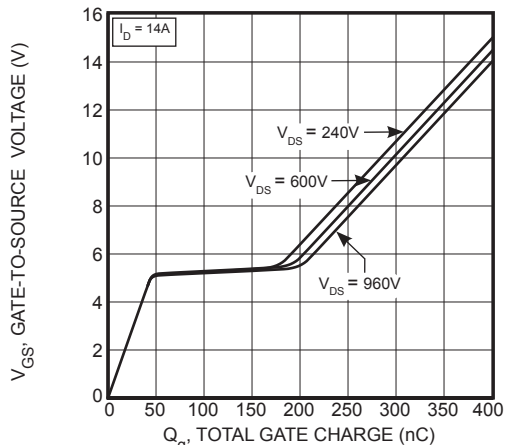

Figure 7, Gate Charge vs Gate-to-Source Voltage

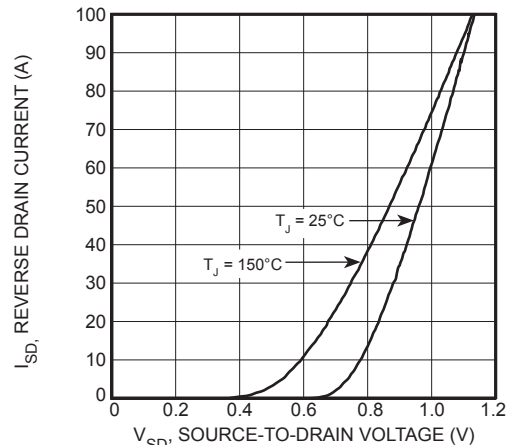
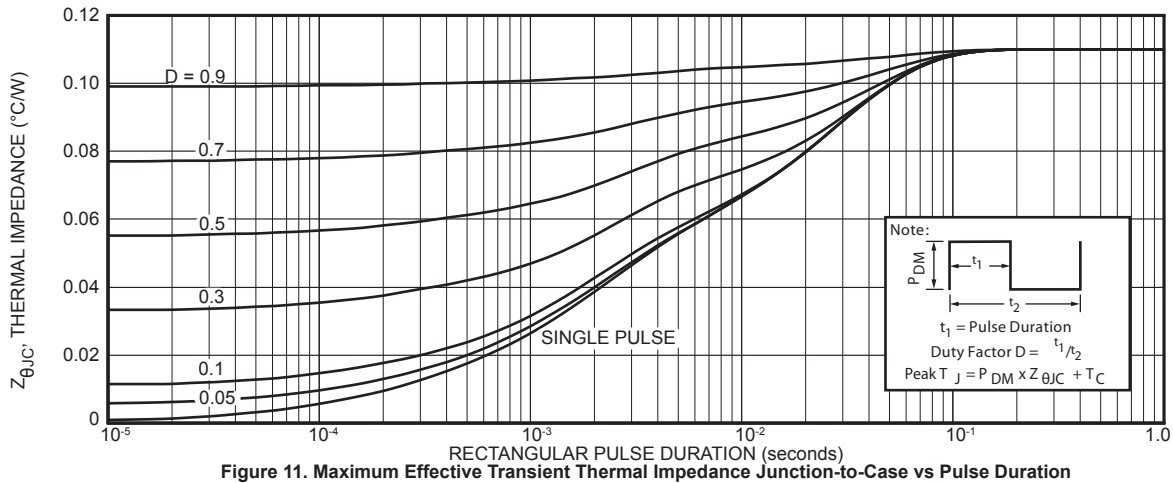
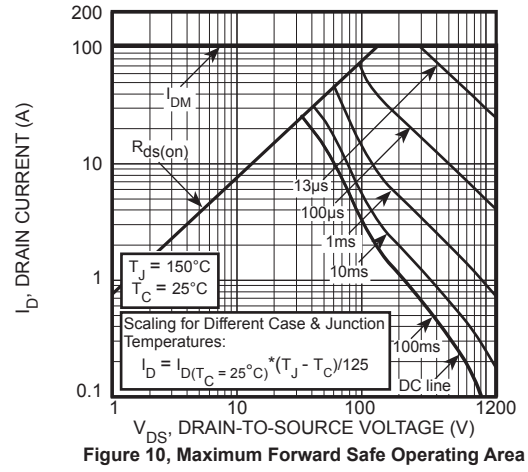
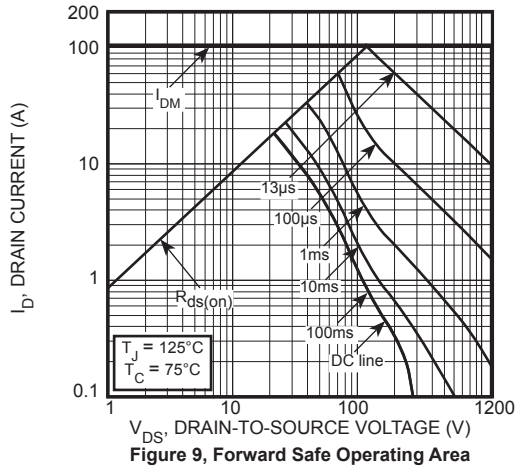

Figure 8, Reverse Drain Current vs Source-to-Drain Voltage



**T-MAX® (B2) Package Outline**

**TO-264 (L) Package Outline**

Ⓜ 100% Sn Plated

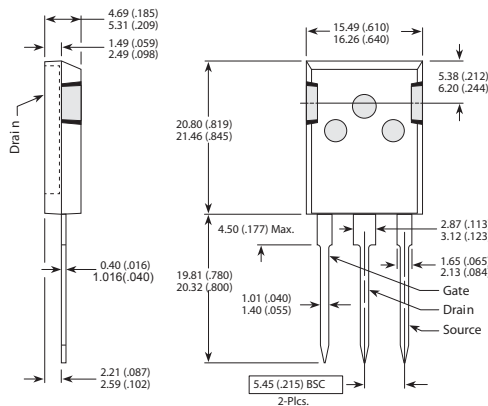

These dimensions are equal to the TO-247 without the mounting hole.

Dimensions in Millimeters (Inches)

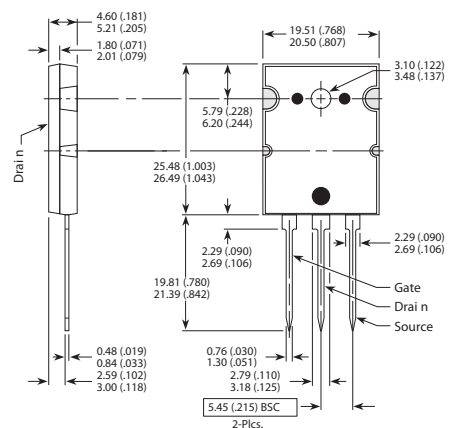

Dimensions in Millimeters (Inches)