



PNP SWITCHING SILICON TRANSISTOR

Qualified per MIL-PRF-19500/290

*Qualified Levels:
JAN, JANTX, JANTXV
and JANS*

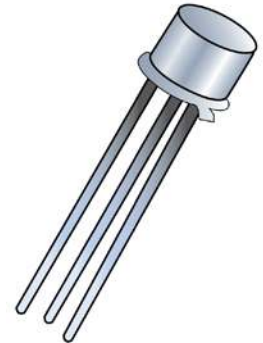
DESCRIPTION

This family of 2N2904 and 2N2905A switching transistors are military qualified up to the JANS level for high-reliability applications. These devices are also available in a TO-5 package. Microsemi also offers numerous other transistor products to meet higher and lower power ratings with various switching speed requirements in both through-hole and surface-mount packages.

Important: For the latest information, visit our website <http://www.microsemi.com>.

FEATURES


- JEDEC registered 2N2904 through 2N2905A series.
- JAN, JANTX, JANTXV, and JANS qualifications are available per MIL-PRF-19500/290. (See [part nomenclature](#) for all available options.)
- RoHS compliant versions available (commercial grade only).



**TO-39 (TO-205AD)
Package**

Also available in:

TO-5 package
(long-leaded)

 [2N2904AL & 2N2905AL](#)

APPLICATIONS / BENEFITS

- General purpose transistors for high speed switching applications.
- Military and other high-reliability applications.

MAXIMUM RATINGS

Parameters / Test Conditions	Symbol	Value		Unit
		2N2904 2N2905	2N2904A 2N2905A	
Collector-Emitter Voltage	V_{CEO}	40	60	V
Collector-Base Voltage	V_{CBO}	60		V
Emitter-Base Voltage	V_{EBO}	5.0		V
Thermal Resistance Junction-to-Ambient	$R_{\theta JA}$	195		$^{\circ}\text{C}/\text{W}$
Thermal Resistance Junction-to-Case	$R_{\theta JC}$	50		$^{\circ}\text{C}/\text{W}$
Collector Current	I_C	600		mA
Total Power Dissipation	P_T	@ $T_A = +25^{\circ}\text{C}$ ⁽¹⁾	0.8	W
		@ $T_C = +25^{\circ}\text{C}$ ⁽²⁾	3.0	
Operating & Storage Junction Temperature Range	T_J & T_{stg}	-65 to +200		$^{\circ}\text{C}$

- Notes:**
1. For derating, see [figures 1 and 2](#).
 2. For thermal impedance, see [figures 3 and 4](#).

MSC – Lawrence

6 Lake Street,
Lawrence, MA 01841
Tel: 1-800-446-1158 or
(978) 620-2600
Fax: (978) 689-0803

MSC – Ireland

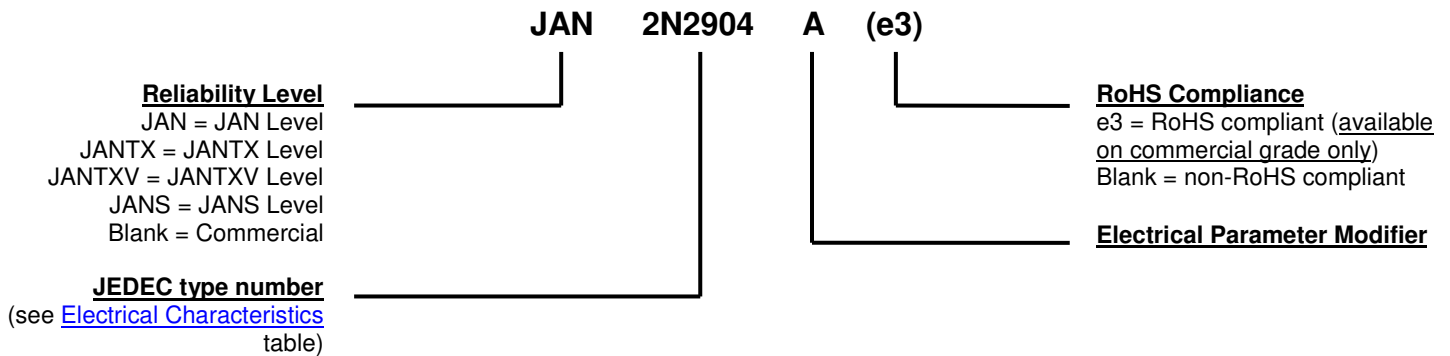
Gort Road Business Park,
Ennis, Co. Clare, Ireland
Tel: +353 (0) 65 6840044
Fax: +353 (0) 65 6822298

Website:

www.microsemi.com

MECHANICAL and PACKAGING

- CASE: Hermetically sealed, kovar base, nickel cap.
- TERMINALS: Leads are kovar, nickel plated, and finish is solder dip (Sn63/Pb37). Can be RoHS compliant with pure matte-tin (commercial grade only).
- MARKING: Part number, date code, manufacturer's ID.
- POLARITY: PNP (see package outline).
- WEIGHT: Approximately 1.064 grams.
- See [Package Dimensions](#) on last page.

PART NOMENCLATURE

SYMBOLS & DEFINITIONS

Symbol	Definition
C_{obo}	Common-base open-circuit output capacitance.
I_{CEO}	Collector cutoff current, base open.
I_{CEX}	Collector cutoff current, circuit between base and emitter.
I_{EBO}	Emitter cutoff current, collector open.
h_{FE}	Common-emitter static forward current transfer ratio.
V_{CEO}	Collector-emitter voltage, base open.
V_{CBO}	Collector-emitter voltage, emitter open.
V_{EBO}	Emitter-base voltage, collector open.

ELECTRICAL CHARACTERISTICS @ $T_A = +25\text{ }^\circ\text{C}$, unless otherwise noted

Parameters / Test Conditions	Symbol	Min.	Max.	Unit
OFF CHARACTERISTICS				
Collector-Emitter Breakdown Current $I_C = 10\text{ mA}$ 2N2904, 2N2905 2N2904A, 2N2905A	$V_{(BR)CEO}$	40 60		V
Collector-Emitter Cutoff Voltage $V_{CE} = 40\text{ V}$ $V_{CE} = 60\text{ V}$ 2N2904, 2N2905 2N2904A, 2N2905A	I_{CES}		1.0	μA
Collector-Base Cutoff Current $V_{CB} = 60\text{ V}$ All Types	I_{CBO1}		10	μA
$V_{CB} = 50\text{ V}$ 2N2904, 2N2905 2N2904A, 2N2905A	I_{CBO2}		20 10	nA nA
$V_{CB} = 50\text{ V @ } T_A = +150\text{ }^\circ\text{C}$ 2N2904, 2N2905 2N2904A, 2N2905A	I_{CBO3}		20 10	μA μA
Emitter-Base Cutoff Current $V_{EB} = 3.5\text{ V}$ $V_{EB} = 5.0\text{ V}$	I_{EBO}		50 10	nA μA
ON CHARACTERISTICS ⁽¹⁾				
Forward-Current Transfer Ratio $I_C = 0.1\text{ mA, } V_{CE} = 10\text{ V}$ 2N2904 2N2905 2N2904A 2N2905A	h_{FE}		20 35 40 75	
$I_C = 1.0\text{ mA, } V_{CE} = 10\text{ V}$ 2N2904 2N2905 2N2904A 2N2905A		25 50 40 100	175 450 175 450	
$I_C = 10\text{ mA, } V_{CE} = 10\text{ V}$ 2N2904 2N2905 2N2904A 2N2905A		35 75 40 100		
$I_C = 150\text{ mA, } V_{CE} = 10\text{ V}$ 2N2904, 2N2904A 2N2905, 2N2905A		40 100	120 300	
$I_C = 500\text{ mA, } V_{CE} = 10\text{ V}$ 2N2904 2N2905 2N2904A 2N2905A		20 30 40 50		

ELECTRICAL CHARACTERISTICS @ $T_A = +25\text{ }^\circ\text{C}$, unless otherwise noted (continued)

Parameters / Test Conditions	Symbol	Min.	Max.	Unit
ON CHARACTERISTICS ⁽¹⁾ (continued)				
Collector-Emitter Saturation Voltage $I_C = 150\text{ mA}$, $I_B = 15\text{ mA}$ $I_C = 500\text{ mA}$, $I_B = 50\text{ mA}$	$V_{CE(sat)}$		0.4 1.6	V
Base-Emitter Saturation Voltage $I_C = 150\text{ mA}$, $I_B = 15\text{ mA}$ $I_C = 500\text{ mA}$, $I_B = 50\text{ mA}$	$V_{BE(sat)}$		1.3 2.6	V

(1) Pulse Test: Pulse Width = 300 μs , duty cycle $\leq 2.0\%$.

DYNAMIC CHARACTERISTICS

Parameters / Test Conditions	Symbol	Min.	Max.	Unit
Small-Signal Short-Circuit Forward-Current Transfer Ratio $I_C = 1.0\text{ mA}$, $V_{CE} = 10\text{ V}$, $f = 1.0\text{ kHz}$ 2N2904 2N2905 2N2904A, 2N2905A	h_{fe}		25 50 40	
Small-Signal Short-Circuit Forward-Current Transfer Ratio $I_C = 50\text{ mA}$, $V_{CE} = 20\text{ V}$, $f = 100\text{ MHz}$	$ h_{fe} $		2.0	
Output Capacitance $V_{CB} = 10\text{ V}$, $I_E = 0$, $100\text{ kHz} \leq f \leq 1.0\text{ MHz}$	C_{obo}		8.0	pF
Input Capacitance $V_{EB} = 2.0\text{ V}$, $I_C = 0$, $100\text{ kHz} \leq f \leq 1.0\text{ MHz}$	C_{ibo}		30	pF

SWITCHING CHARACTERISTICS

Parameters / Test Conditions	Symbol	Min.	Max.	Unit
Turn-On Time	t_{on}		45	ns
Turn-Off Time	t_{off}		300	ns

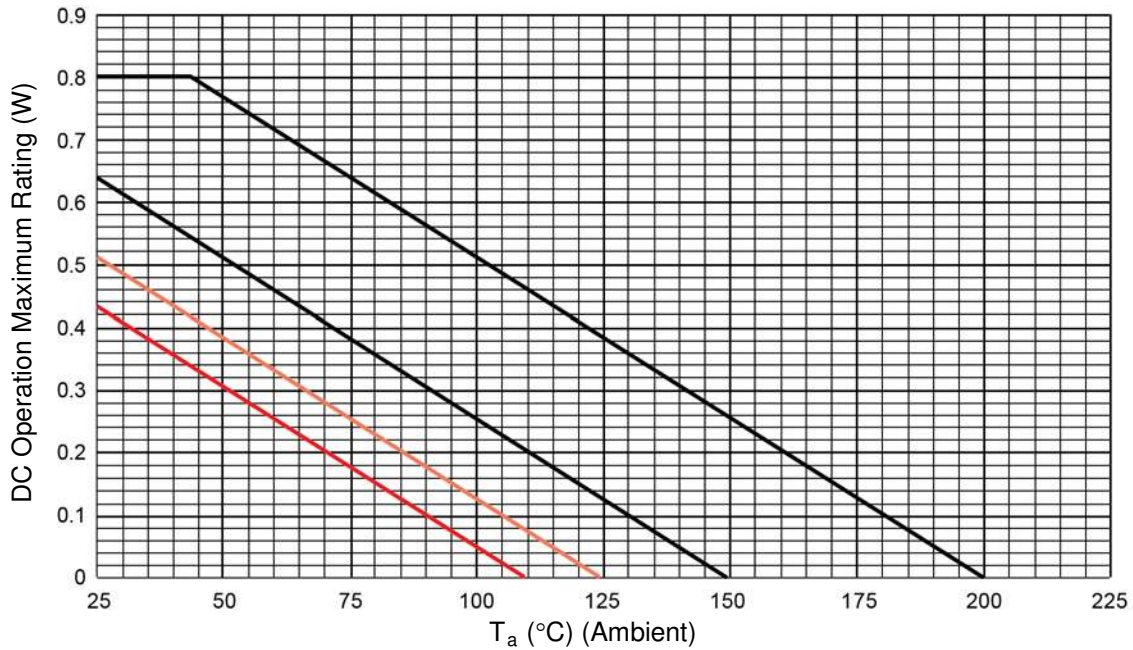
GRAPHS


FIGURE 1
Derating (R_{θJA}) PCB

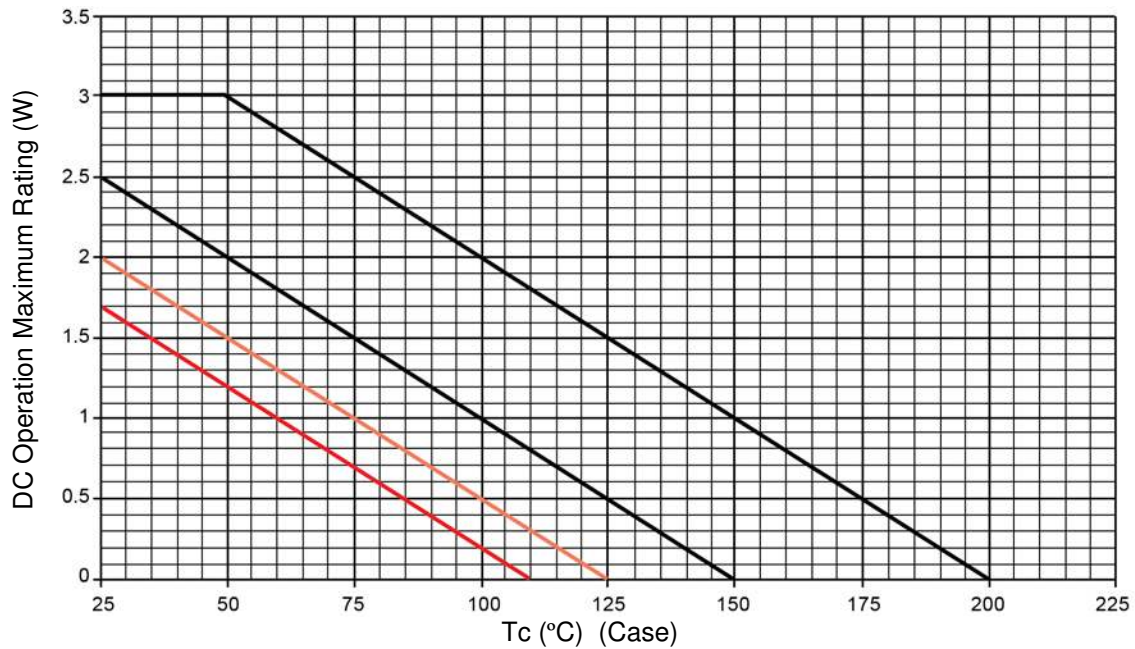


FIGURE 2
Derating (R_{θJA}) PCB

GRAPHS (continued)

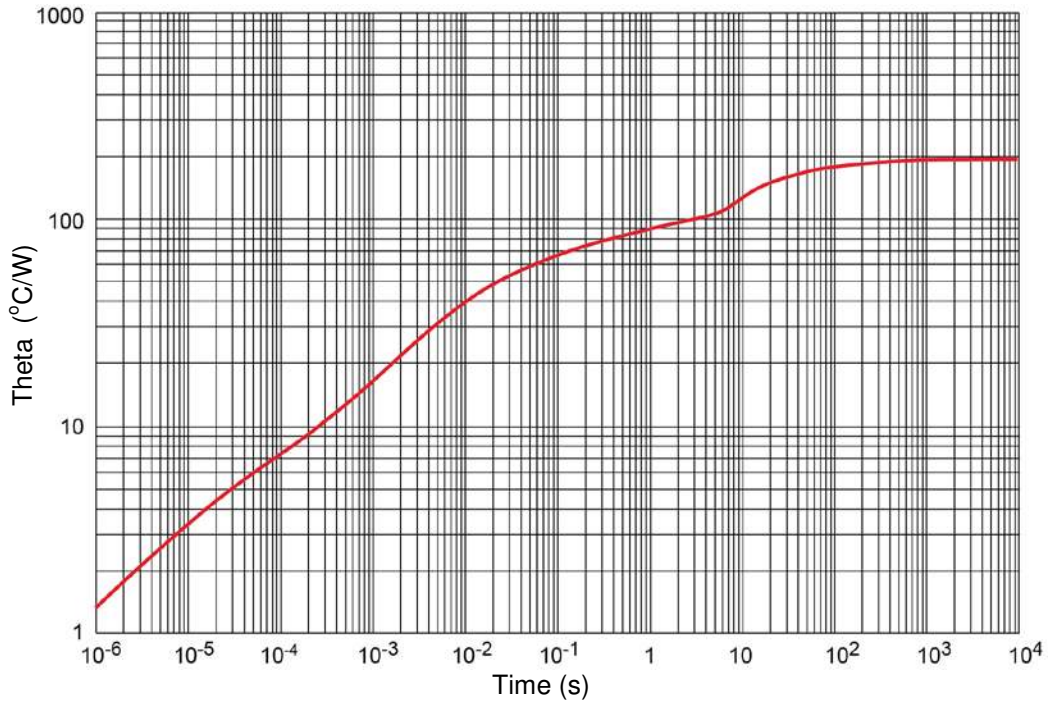


FIGURE 3

Thermal impedance graph ($R_{\theta JA}$)

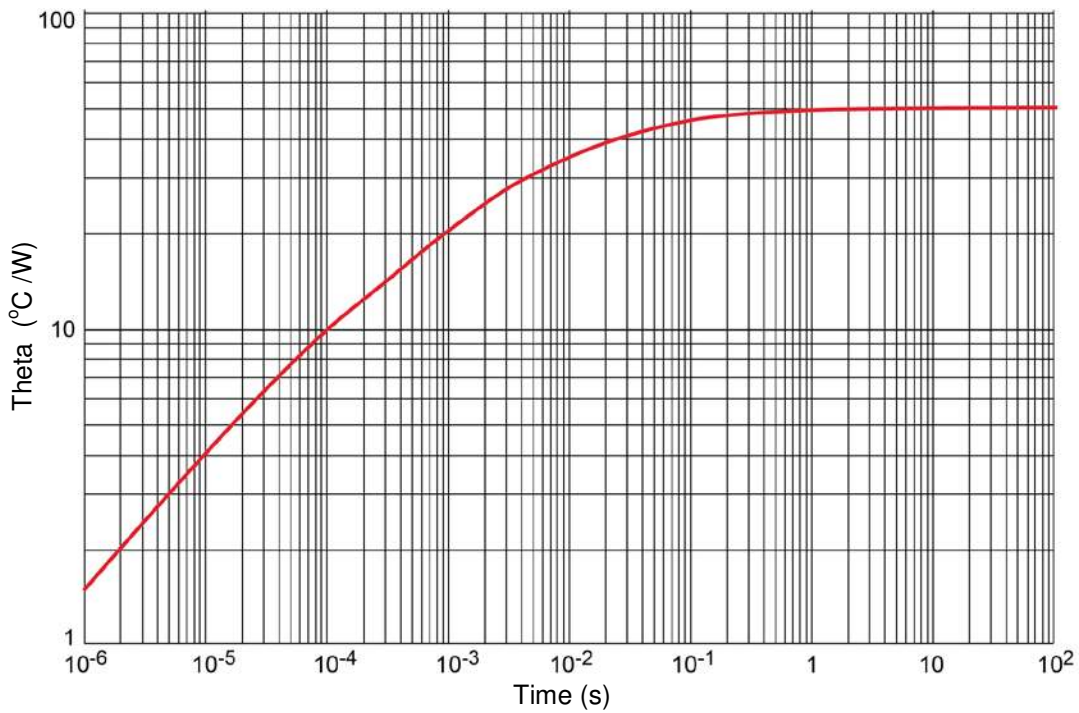
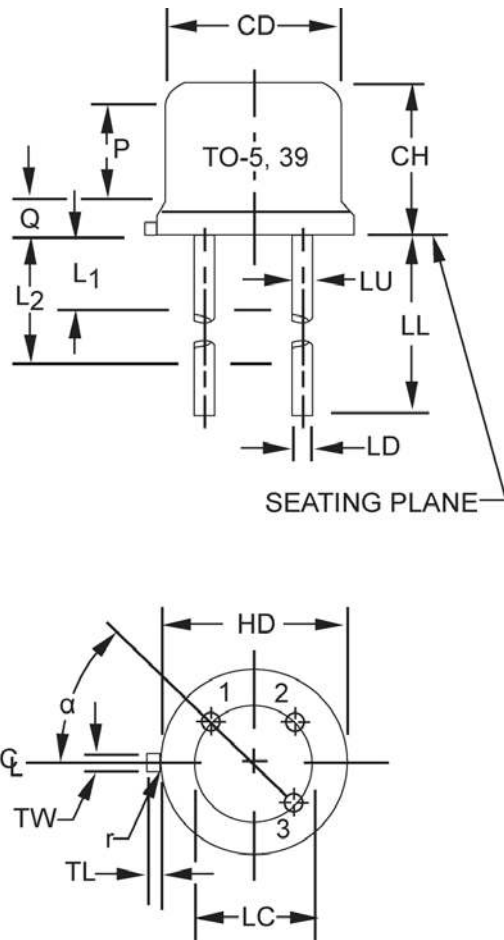


FIGURE 4

Thermal impedance graph ($R_{\theta JA}$)

PACKAGE DIMENSIONS


Symbol	Dimensions				Note
	Inch		Millimeters		
	Min	Max	Min	Max	
CD	0.305	0.335	7.75	8.51	
CH	0.240	0.260	6.10	6.60	
HD	0.335	0.370	8.51	9.40	
LC	0.200 TP		5.08 TP		6
LD	0.016	0.021	0.41	0.53	7, 8
LL	0.500	0.750	12.70	19.05	7, 8, 12
LU	0.016	0.019	0.41	0.48	7, 8
L1		0.050		1.27	7, 8
L2	0.250		6.35		7, 8
P	0.100		2.54		
Q		0.050		1.27	5
TL	0.029	0.045	0.74	1.14	4
TW	0.028	0.034	0.71	0.86	3
r		0.010		0.25	10
α	45° TP		45° TP		6

NOTES:

- Dimensions are in inches.
- Millimeters are given for general information only.
- Beyond r (radius) maximum, TW shall be held for a minimum length of .011 (0.28 mm).
- Dimension TL measured from maximum HD.
- Body contour optional within zone defined by HD, CD, and Q.
- Leads at gauge plane .054 +.001 -.000 inch (1.37 +0.03 -0.00 mm) below seating plane shall be within .007 inch (0.18 mm) radius of true position (TP) at maximum material condition (MMC) relative to tab at MMC.
- Dimension LU applies between L1 and L2. Dimension LD applies between L2 and LL minimum. Diameter is uncontrolled in L1 and beyond LL minimum.
- All three leads.
- The collector shall be internally connected to the case.
- Dimension r (radius) applies to both inside corners of tab.
- In accordance with ASME Y14.5M, diameters are equivalent to Φ x symbology.
- For "L" suffix devices, dimension LL is 1.50 (38.10 mm) minimum, 1.75 (44.45 mm) maximum.
- Lead 1 = emitter, lead 2 = base, lead 3 = collector.