

HEIDI-O

~50° x 11° oval beam

SPECIFICATION:

Dimensions	Ø 21.6 mm
Height	11.7 mm
Fastening	tape, pin
ROHS compliant	yes ⓘ

MATERIALS:

Component	Type	Material	Colour	Finish
HEIDI-O	Single lens	PMMA	clear	
HEIDI-TAPE	Tape	Acrylic foam	black	



ORDERING INFORMATION:

Component	Type	Qty in box	MOQ	MPQ	Box weight (kg)
CA12949_HEIDI-O	Single lens	3264	204	204	11.1
» Box size: 480 x 280 x 300 mm					

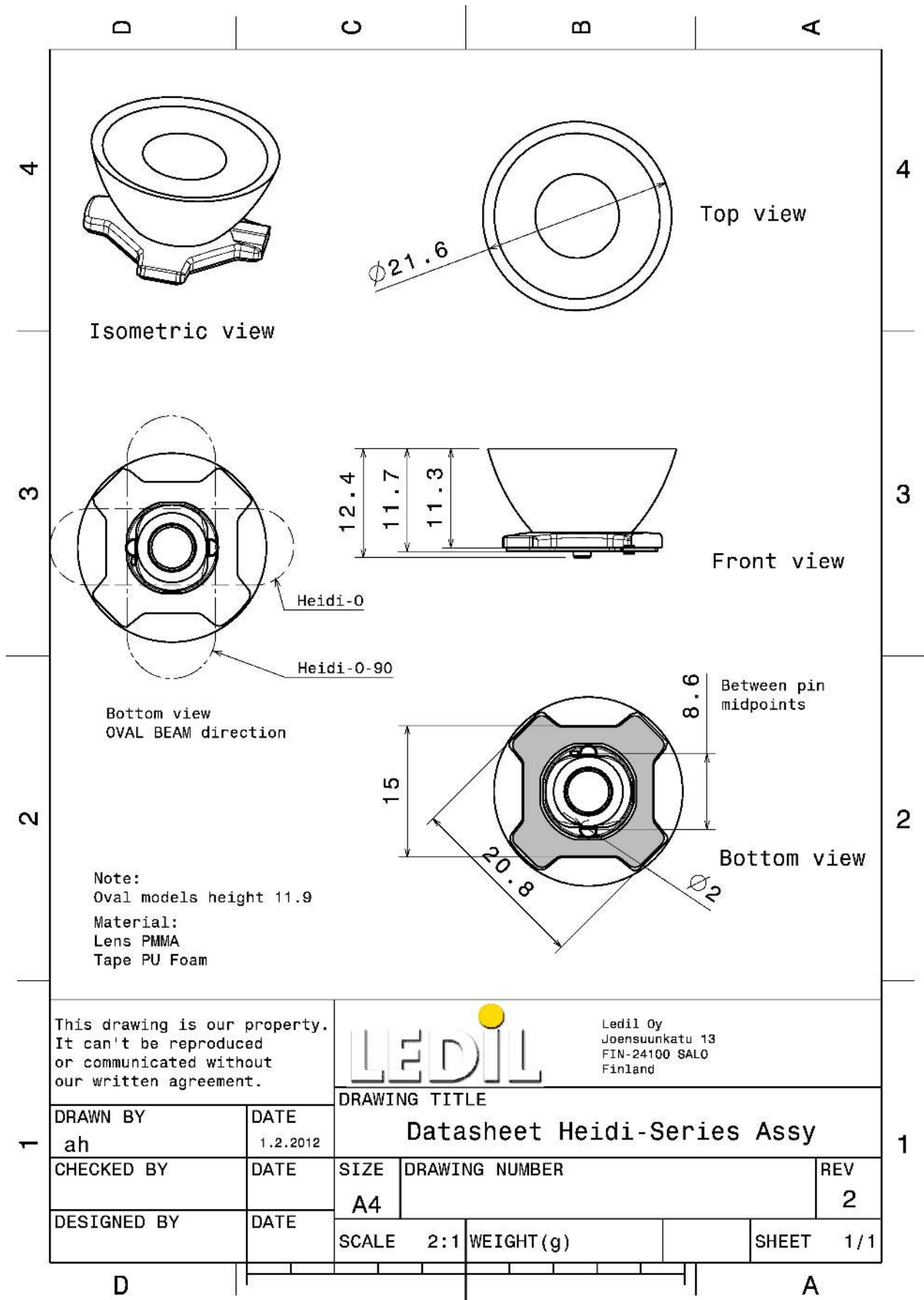

See also our general installation guide: www.ledil.com/installation_guide

OPTICAL RESULTS (MEASURED):

CREE ⇄ LED

LED XHP35 HD
 FWHM / FWTM 51.0 + 18.0° / 84.0 + 50.0°
 Efficiency 77 %
 Peak intensity 2.2 cd/lm
 LEDs/each optic 1
 Light colour White
 Required components:



CREE ⇄ LED

LED XHP35 HI
 FWHM / FWTM 53.0 + 14.0° / 80.0 + 40.0°
 Efficiency 79 %
 Peak intensity 3 cd/lm
 LEDs/each optic 1
 Light colour White
 Required components:

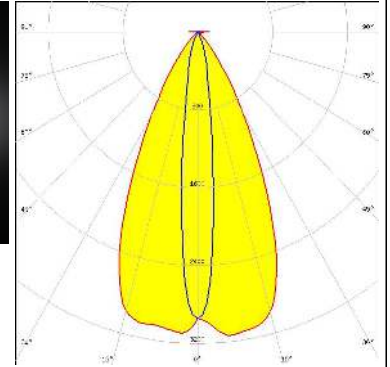

CREE ⇄ LED

LED XP-G2
 FWHM / FWTM 52.0 + 12.0° / 78.0 + 33.0°
 Efficiency 91 %
 Peak intensity 3.3 cd/lm
 LEDs/each optic 1
 Light colour White
 Required components:

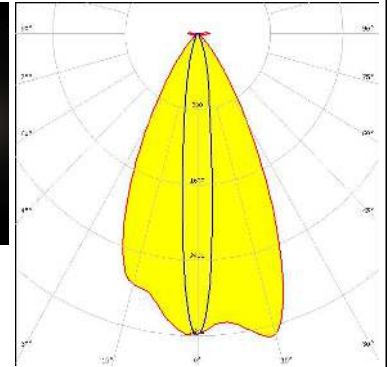

CREE ⇄ LED

LED XP-G3
 FWHM / FWTM 51.0 + 14.0° / 79.0 + 39.0°
 Efficiency 90 %
 Peak intensity 2.7 cd/lm
 LEDs/each optic 1
 Light colour White
 Required components:

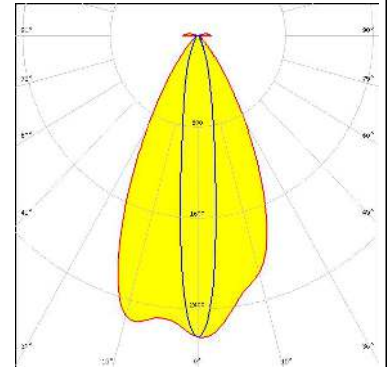

OPTICAL RESULTS (MEASURED):

CREE LED

LED XP-L HD
 FWHM / FWTM 52.0 + 16.0° / 79.0 + 41.0°
 Efficiency 81 %
 Peak intensity 2.5 cd/lm
 LEDs/each optic 1
 Light colour White
 Required components:

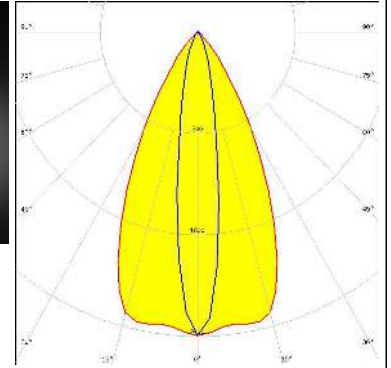

LUMILEDS

LED LUXEON Rebel ES
 FWHM / FWTM 53.0 + 12.0° / 76.0 + 33.0°
 Efficiency 82 %
 Peak intensity 3.4 cd/lm
 LEDs/each optic 1
 Light colour White
 Required components:

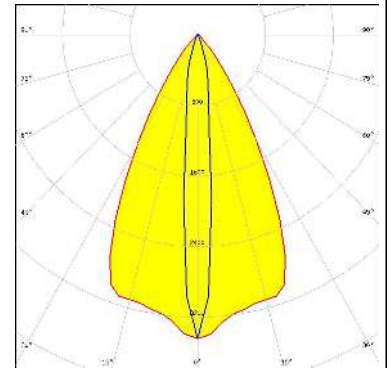

LUMINUS

LED SST-10-B130
 FWHM / FWTM 54.0 + 9.5° / 77.0 + 28.0°
 Efficiency 90 %
 Peak intensity 3.8 cd/lm
 LEDs/each optic 1
 Light colour Blue
 Required components:

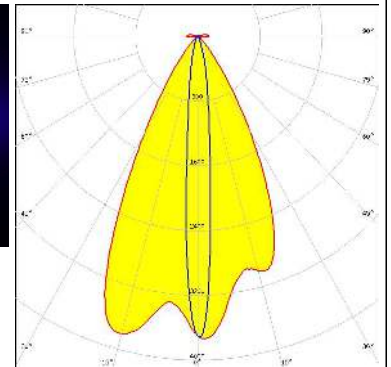
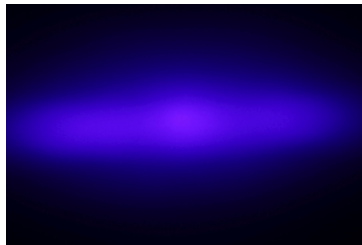



NICHIA

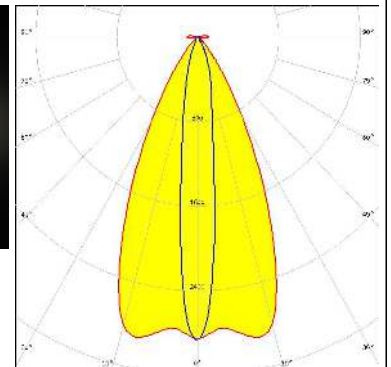
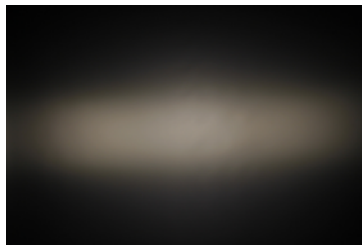

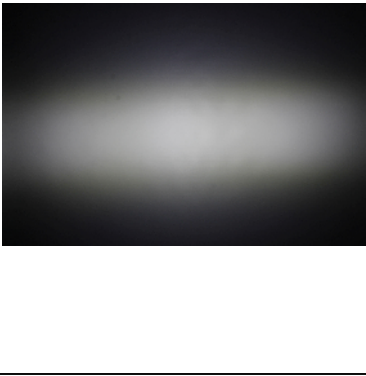
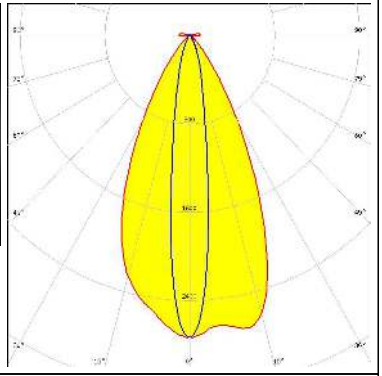
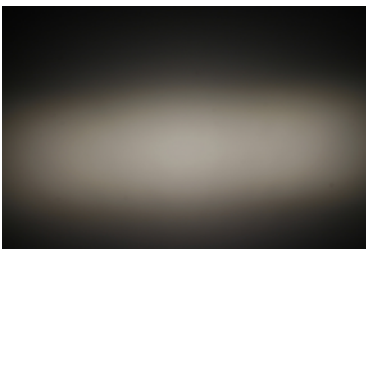
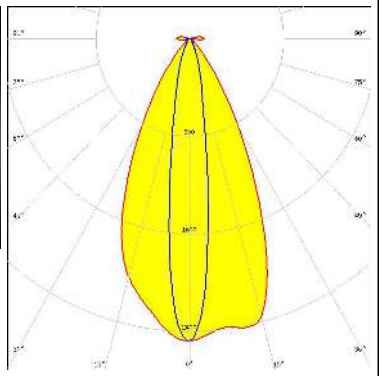
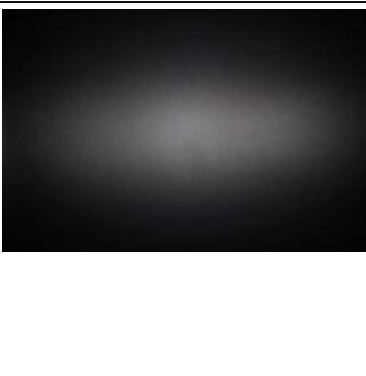
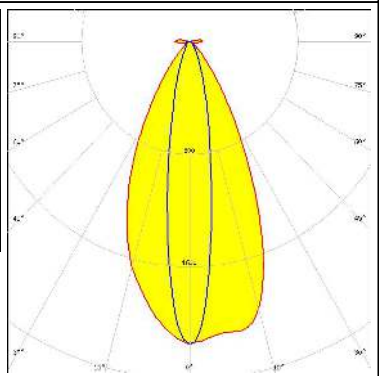

LED NVSW219D
 FWHM / FWTM 51.0 + 13.0° / 78.0 + 40.0°
 Efficiency 91 %
 Peak intensity 2.9 cd/lm
 LEDs/each optic 1
 Light colour White
 Required components:

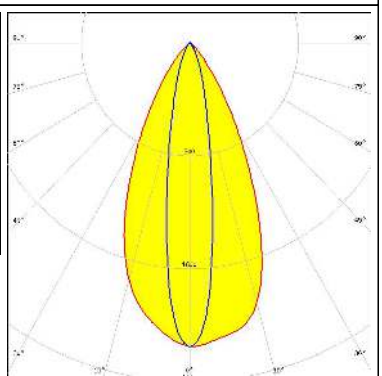

OPTICAL RESULTS (MEASURED):

<p>NICHIA</p> <p>LED NVSW319B FWHM / FWTM 51.0 + 15.0° / 80.0 + 38.0° Efficiency 91 % Peak intensity 2.7 cd/lm LEDs/each optic 1 Light colour White Required components:</p>		
<p>NICHIA</p> <p>LED NVSW3x9A FWHM / FWTM 51.0 + 15.0° / 80.0 + 39.0° Efficiency 89 % Peak intensity 2.5 cd/lm LEDs/each optic 1 Light colour White Required components:</p>		
<p>NICHIA</p> <p>LED NVSW519A FWHM / FWTM 50.0 + 18.0° / 81.0 + 44.0° Efficiency 87 % Peak intensity 2.1 cd/lm LEDs/each optic 1 Light colour White Required components:</p>		
<p>NICHIA</p> <p>LED NWSx229A FWHM / FWTM 50.0 + 18.0° / 80.0 + 44.0° Efficiency 76 % Peak intensity 2.2 cd/lm LEDs/each optic 1 Light colour White Required components:</p>		

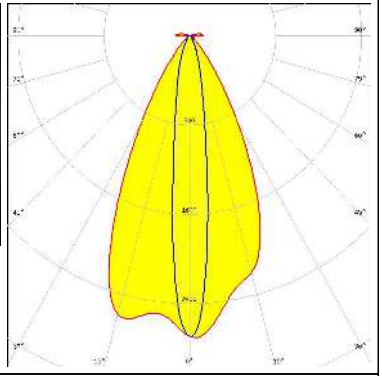
OPTICAL RESULTS (MEASURED):

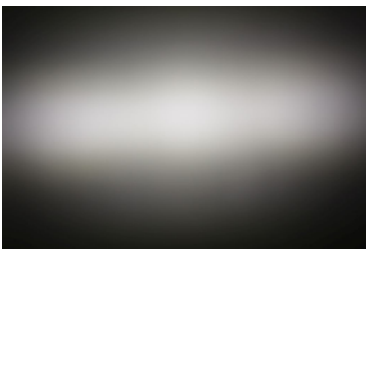
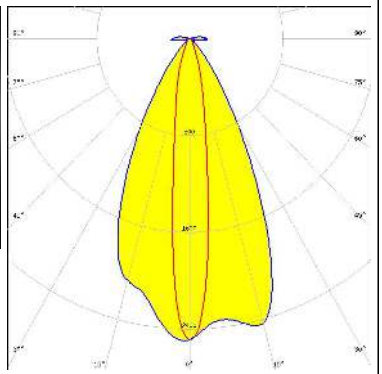
<p> SEOUL SEMICONDUCTOR</p> <p>LED Z5M3</p> <p>FWHM / FWTM 52.0 + 13.0° / 79.0 + 39.0°</p> <p>Efficiency 92 %</p> <p>Peak intensity 2.7 cd/lm</p> <p>LEDs/each optic 1</p> <p>Light colour White</p> <p>Required components:</p>		
<p> SEOUL SEMICONDUCTOR</p> <p>LED Z8Y22P</p> <p>FWHM / FWTM 52.0 + 14.0° / 79.0 + 39.0°</p> <p>Efficiency 90 %</p> <p>Peak intensity 2.5 cd/lm</p> <p>LEDs/each optic 1</p> <p>Light colour White</p> <p>Required components:</p>		

OPTICAL RESULTS (SIMULATED):

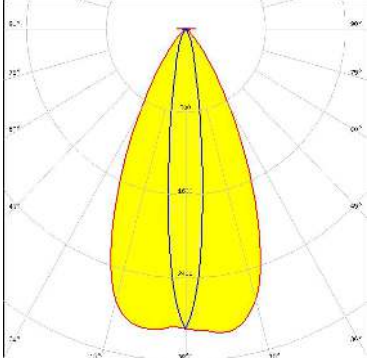
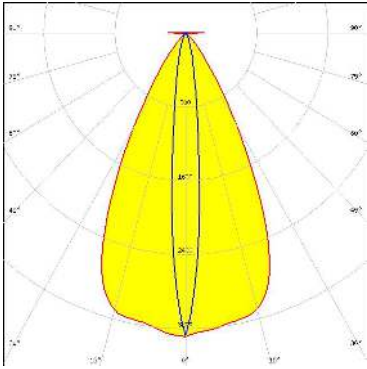
<p>CREE → LED</p> <p>LED: XP-G2 HE FWHM / FWTM: 50.0 + 14.0° / 78.0 + 35.0° Efficiency: 88 % Peak intensity: 3 cd/lm LEDs/each optic: 1 Light colour: White Required components:</p>	
<p>LUMILEDS</p> <p>LED: LUXEON A FWHM / FWTM: 51.0 + 12.0° / 76.0 + 30.0° Efficiency: 84 % Peak intensity: 3.4 cd/lm LEDs/each optic: 1 Light colour: White Required components:</p>	
<p>LUMILEDS</p> <p>LED: LUXEON HL2Z FWHM / FWTM: 54.0 + 10.0° / 76.0 + 28.0° Efficiency: 89 % Peak intensity: 3.3 cd/lm LEDs/each optic: 1 Light colour: White Required components:</p>	
<p>LUMILEDS</p> <p>LED: LUXEON R FWHM / FWTM: 53.0 + 12.0° Efficiency: % LEDs/each optic: 1 Light colour: White Required components:</p>	

OPTICAL RESULTS (SIMULATED):

LUMILEDS

LED LUXEON SunPlus 20 Line (120 deg)
 FWHM / FWTM 52.0 + 9.0° / 76.0 + 22.0°
 Efficiency 91 %
 Peak intensity 4.6 cd/lm
 LEDs/each optic 1
 Light colour White
 Required components:

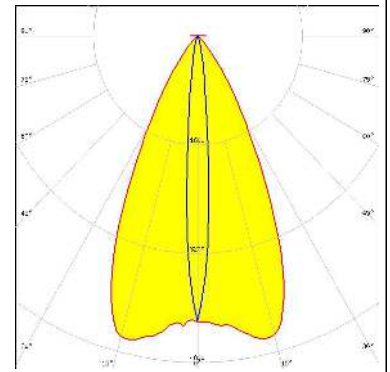

LUMILEDS

LED LUXEON SunPlus 20 Line (150 deg)
 FWHM / FWTM 52.0 + 10.0° / 76.0 + 20.0°
 Efficiency 87 %
 Peak intensity 4.3 cd/lm
 LEDs/each optic 1
 Light colour White
 Required components:

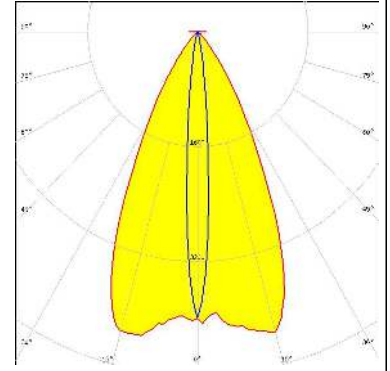

NICHIA

LED NCSxE17A
 FWHM / FWTM 54.0 + 24.0° / 180.0 + 54.0°
 Efficiency 81 %
 Peak intensity 1.5 cd/lm
 LEDs/each optic 4
 Light colour White
 Required components:

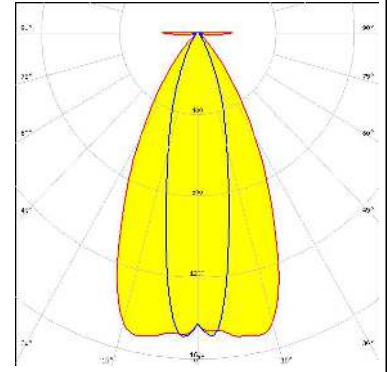

OSRAM

OSRAM Opto Semiconductors
 LED OSLOM Black
 FWHM / FWTM 53.0 + 9.0° / 54.0 + 23.0°
 Efficiency 88 %
 Peak intensity 4 cd/lm
 LEDs/each optic 1
 Light colour White
 Required components:

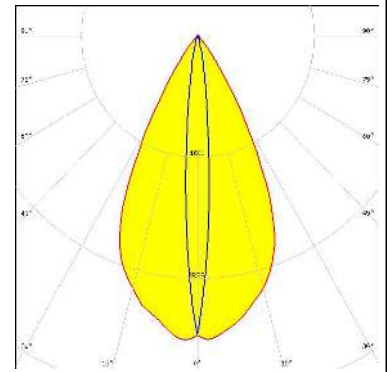

OPTICAL RESULTS (SIMULATED):

OSRAM
Opto Semiconductors

LED	OSLON Black Flat (LUW HWQP)
FWHM / FWTM	54.0 + 8.0° / 74.0 + 18.0°
Efficiency	89 %
Peak intensity	4.8 cd/lm
LEDs/each optic	1
Light colour	White
Required components:	

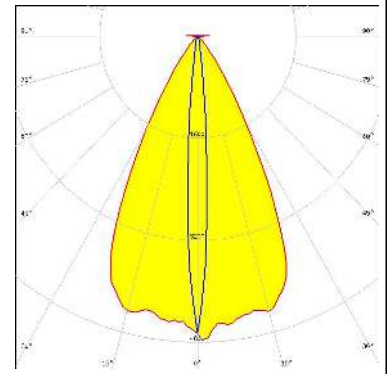

GENERAL INFORMATION:

NOTE: The typical beam angle will be changed by different color, chip size and chip position tolerance. The typical total beam angle is the full angle measured where the luminous intensity is half of the peak value.

MATERIALS:

As part of our continuous research and improvement processes, and to ensure the best possible quality and availability of our products, LEDiL reserves the right to change material grades without notice.

PRODUCT DATA USER AGREEMENT AND DISCLAIMER:

The measured data in the provided downloadable LEDiL Product Datasheets and Mechanical 2D-Drawings is rounded and provided as reference for planning. LEDiL Oy's optical specifications have been verified by conducting performance testing of the products in accordance with the company's quality system. The reported data are averaged results of multiple measurements with typical variation. LEDiL Oy reserves the right to without prior notification make changes and improvements to its products.

LEDiL Oy assumes neither warranty, nor guarantee nor any other liability of any kind for the contents and correctness of the provided data. The provided data has been generated with highest diligence but the provided data may in reality not represent the complete possible variation range of all intrinsic parameters. Therefore, in certain cases a deviation from the provided data could occur.

LEDiL Oy reserves the right to undertake technical changes of its products without further notification which could lead to changes in the provided data. LEDiL Oy assumes no liability of any kind for the possible deviation from any provided data or any other damage resulting from the usage of the provided data.

The user agrees to this disclaimer and user agreement with the download or usage of the provided files.

LEDiL Oy

Joensuunkatu 13
FI-24240 SALO
Finland

LEDiL Inc.

228 West Page Street
Suite D
Sycamore IL 60178
USA

Ledil Optics Technology (Shenzhen) Co., Ltd.

405 , Block B
Casic Motor Building
Shenzhen 518057
P.R.CHINA

Local sales and technical support

[www.ledil.com/
where_to_buy](http://www.ledil.com/where_to_buy)

Shipping locations

Salo, Finland
Hong Kong, China

Distribution Partners

[www.ledil.com/
where_to_buy](http://www.ledil.com/where_to_buy)