

Thermally-Enhanced High Power RF LDMOS FET 150 W, 1450 – 1500 MHz, 1600 – 1700 MHz

Description

The PTF141501E is a 150-watt, *GOLDMOS*® FET intended for DAB applications. This device is characterized for Digital Audio Broadcast operation in the 1450 to 1500 MHz band. Thermally-enhanced packaging provides the coolest operation available. Full gold metallization ensures excellent device lifetime and reliability.

PTF141501E
Package H-30260-2

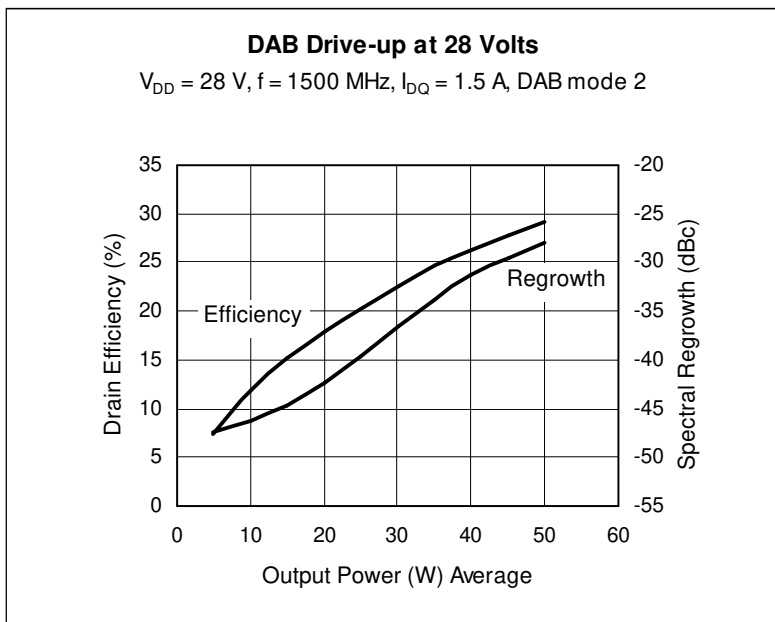

Features

- Thermally-enhanced package, pB-free and RoHS-compliant
- Broadband internal matching
- Typical DAB Mode 2 performance at 1500 MHz, 32 V
 - Average output power = 50 W
 - Efficiency = 28%
 - Spectral regrowth = -30 dBc
 - $\Delta 975\text{ kHz } f_C$
- Typical DAB Mode 2 performance at 1500 MHz, 28 V
 - Average output power = 40 W
 - Efficiency = 26%
 - Spectral regrowth = -31 dBc
 - $\Delta 975\text{ kHz } f_C$
- Typical CW performance, 1500 MHz, 28 V
 - Minimum output power = 150 W
 - Linear gain = 16.5 dB
 - Efficiency = 48% at P-1dB
- Integrated ESD protection: Human Body Model, Class 1 (minimum)
- Excellent thermal stability, low HCI drift
- Capable of handling 10:1 VSWR at 28 V, 150 W (CW) output power

RF Characteristics

DAB Measurements (not subject to production test—verified by design/characterization in Infineon test fixture)

$V_{DD} = 32\text{ V}$, $I_{DQ} = 1.5\text{ A}$, $P_{OUT} = 50\text{ W}_{AVG}$, $f = 1500\text{ MHz}$, DAB Mode 2, $f_C \Delta 975\text{ kHz}$

Characteristic	Symbol	Min	Typ	Max	Unit
Spectral Regrowth	RGTH	—	-30	—	dBc
Gain	G_{ps}	—	16.5	—	dB
Drain Efficiency	η_D	—	29	—	%

All published data at $T_{CASE} = 25^\circ\text{C}$ unless otherwise indicated

ESD: Electrostatic discharge sensitive device—observe handling precautions!

RF Characteristics (cont.)

Two-Tone Measurements (tested in Infineon test fixture)

 $V_{DD} = 28\text{ V}$, $I_{DQ} = 1.5\text{ A}$, $P_{OUT} = 150\text{ W}_{PEP}$, $f = 1500\text{ MHz}$, tone spacing = 1 MHz

Characteristic	Symbol	Min	Typ	Max	Unit
Gain	G_{ps}	15.0	16.5	—	dB
Drain Efficiency	η_D	35	—	—	%
Intermodulation Distortion	IMD	—	-30	-28	dBc

DC Characteristics

Characteristic	Conditions	Symbol	Min	Typ	Max	Unit
Drain-Source Breakdown Voltage	$V_{GS} = 0\text{ V}$, $I_D = 10\text{ }\mu\text{A}$	$V_{(BR)DSS}$	65	—	—	V
Drain Leakage Current	$V_{DS} = 28\text{ V}$, $V_{GS} = 0\text{ V}$	I_{DSS}	—	—	1.0	μA
On-State Resistance	$V_{GS} = 10\text{ V}$, $V_{DS} = 0.1\text{ V}$	$R_{DS(on)}$	—	0.07	—	Ω
Operating Gate Voltage	$V_{DS} = 28\text{ V}$, $I_{DQ} = 1.5\text{ A}$	V_{GS}	2.5	3.3	4.0	V
Gate Leakage Current	$V_{GS} = +10\text{ V}$, $V_{DS} = 0\text{ V}$	I_{GSS}	—	—	1.0	μA

Maximum Ratings

Parameter	Symbol	Value	Unit
Drain-Source Voltage	V_{DSS}	65	V
Gate-Source Voltage	V_{GS}	-0.5 to +12	V
Junction Temperature	T_J	200	$^{\circ}\text{C}$
Total Device Dissipation	P_D	438	W
Above 25 $^{\circ}\text{C}$ derate by		2.5	W/ $^{\circ}\text{C}$
Storage Temperature Range	T_{STG}	-40 to +150	$^{\circ}\text{C}$
Thermal Resistance ($T_{CASE} = 70^{\circ}\text{C}$)	$R_{\theta JC}$	0.4	$^{\circ}\text{C/W}$

Ordering Information

Type	Package Outline	Package Description	Marking
PTF141501E	H-30260-2	Thermally-enhanced slotted flange, single-ended	PTF141501E

Typical Performance

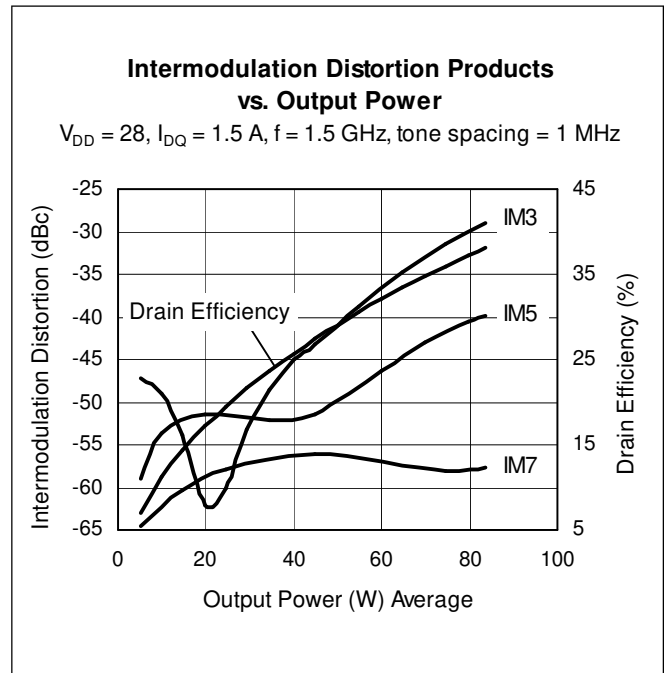
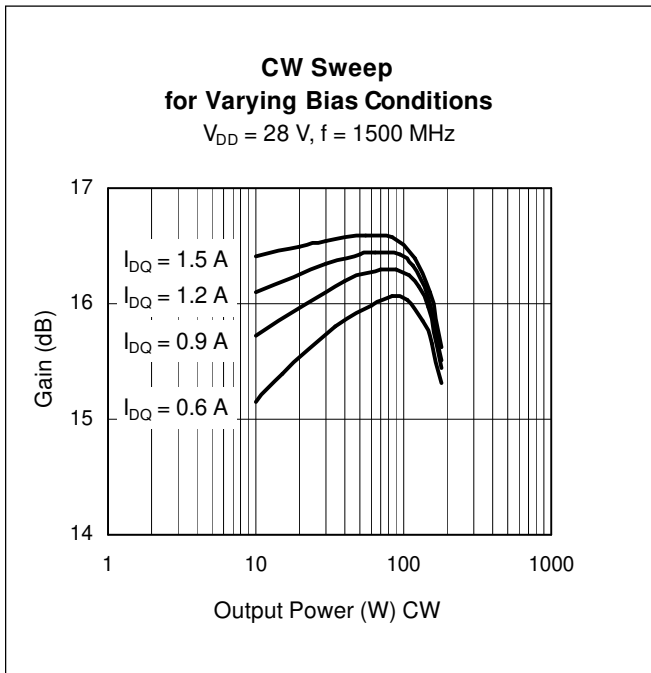
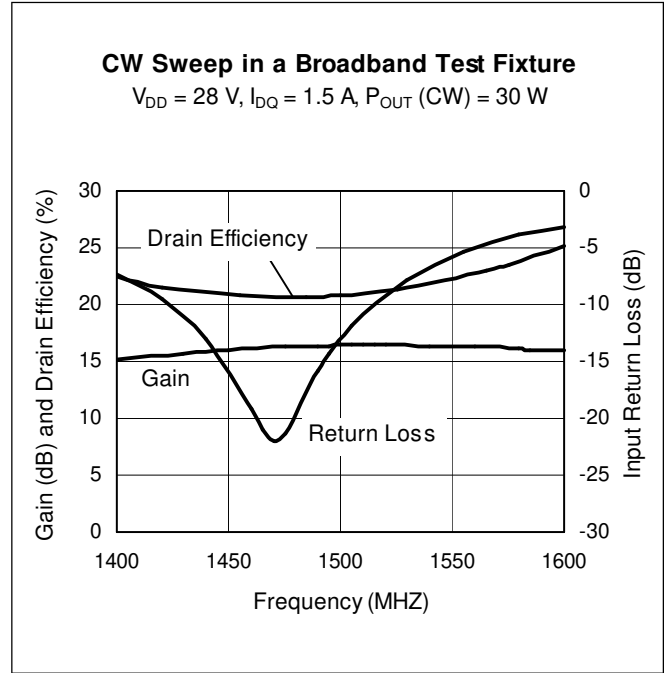
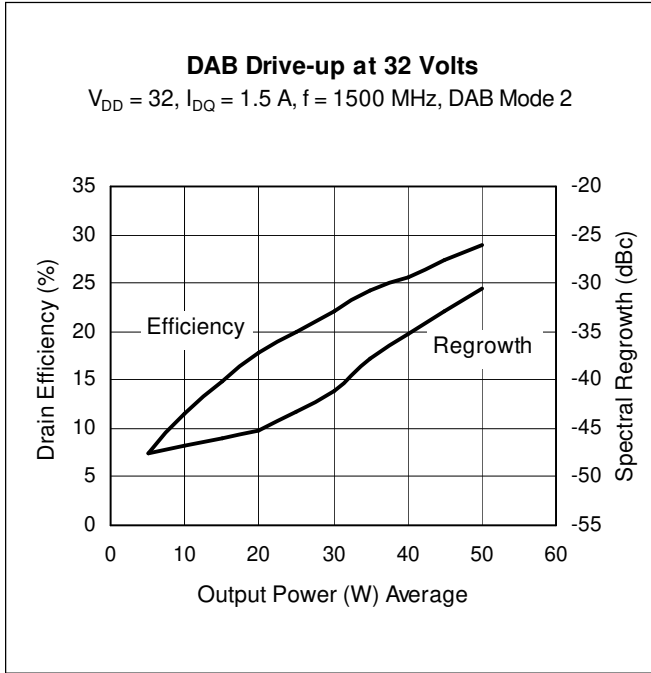

Typical Performance (cont.)

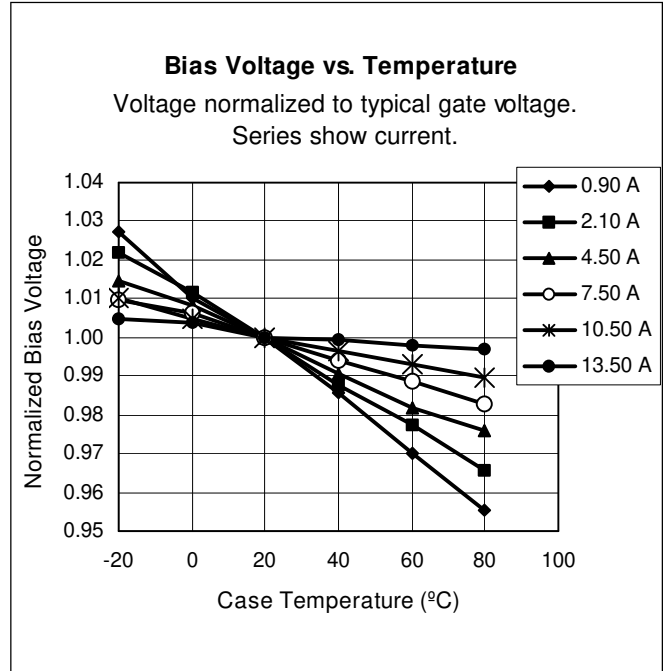
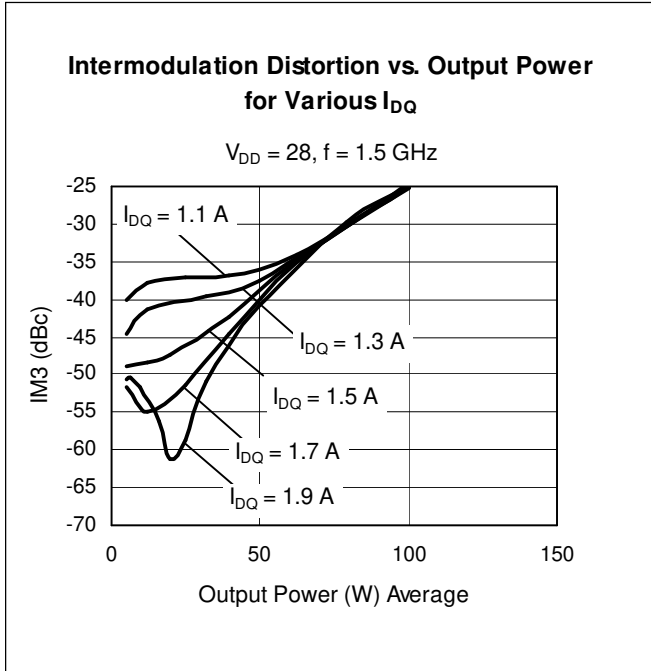

Broadband Circuit Impedance, 1500 MHz

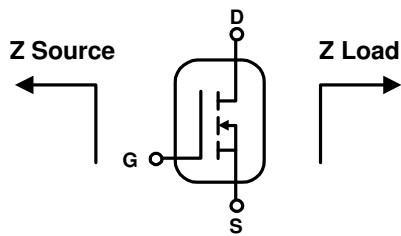

Frequency MHz	Z Source Ω		Z Load Ω	
	R	jX	R	jX
1400	5.00	-6.70	0.94	1.27
1450	4.50	-5.90	0.90	1.73
1500	4.20	-5.10	0.86	2.21
1550	3.90	-4.30	0.82	2.60
1600	3.70	-3.70	0.80	3.05

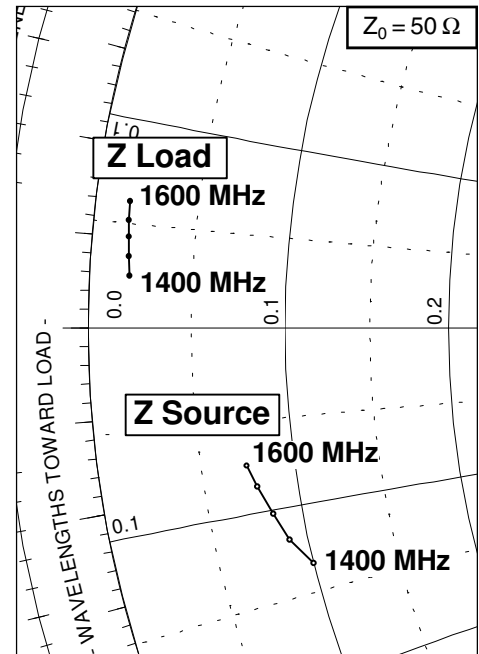

Reference Circuit for 1500 MHz

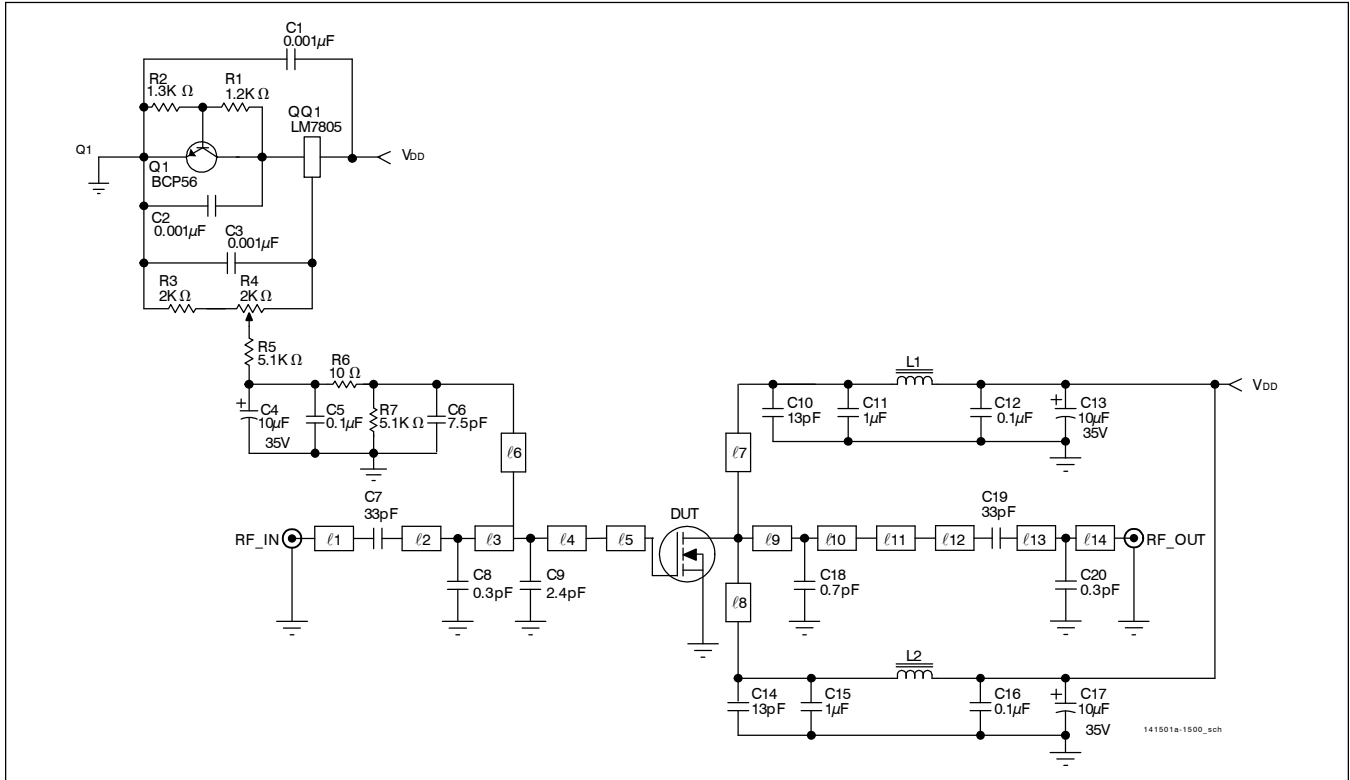

Reference Circuit Schematic for 1500 MHz

Circuit Assembly Information

DUT	PTF141501E	LDMOS Transistor
PCB	0.76 mm [0.030"] thick, $\epsilon_r = 4.5$	TMM4 2 oz. copper, both sides

Microstrip	Electrical Characteristics at 1500 MHz ¹	Dimensions: L x W (mm)	Dimensions: L x W (in.)
l1	0.043 λ , 50.0 Ω	4.67 x 1.47	0.185 x 0.058
l2	0.118 λ , 42.0 Ω	12.70 x 1.85	0.500 x 0.073
l3	0.015 λ , 42.0 Ω	1.57 x 1.85	0.062 x 0.073
l4	0.012 λ , 14.7 Ω	1.22 x 7.57	0.048 x 0.298
l5	0.052 λ , 8.0 Ω	5.08 x 15.19	0.200 x 0.598
l6	0.182 λ , 60.0 Ω	20.17 x 0.97	0.794 x 0.038
l7	0.283 λ , 63.0 Ω	31.45 x 0.89	1.238 x 0.035
l8	0.283 λ , 63.0 Ω	31.45 x 0.89	1.238 x 0.035
l9	0.026 λ , 4.6 Ω	2.46 x 27.89	0.097 x 1.098
l10	0.086 λ , 4.6 Ω	8.23 x 27.89	0.324 x 1.098
l11	0.061 λ , 9.4 Ω	5.97 x 12.62	0.235 x 0.497
l12	0.011 λ , 50.0 Ω	1.14 x 1.47	0.045 x 0.058
l13	0.056 λ , 50.0 Ω	6.10 x 1.47	0.240 x 0.058
l14	0.010 λ , 50.0 Ω	1.07 x 1.47	0.042 x 0.058

¹Electrical Characteristics are rounded.

Reference Circuit for 1500 MHz (cont.)

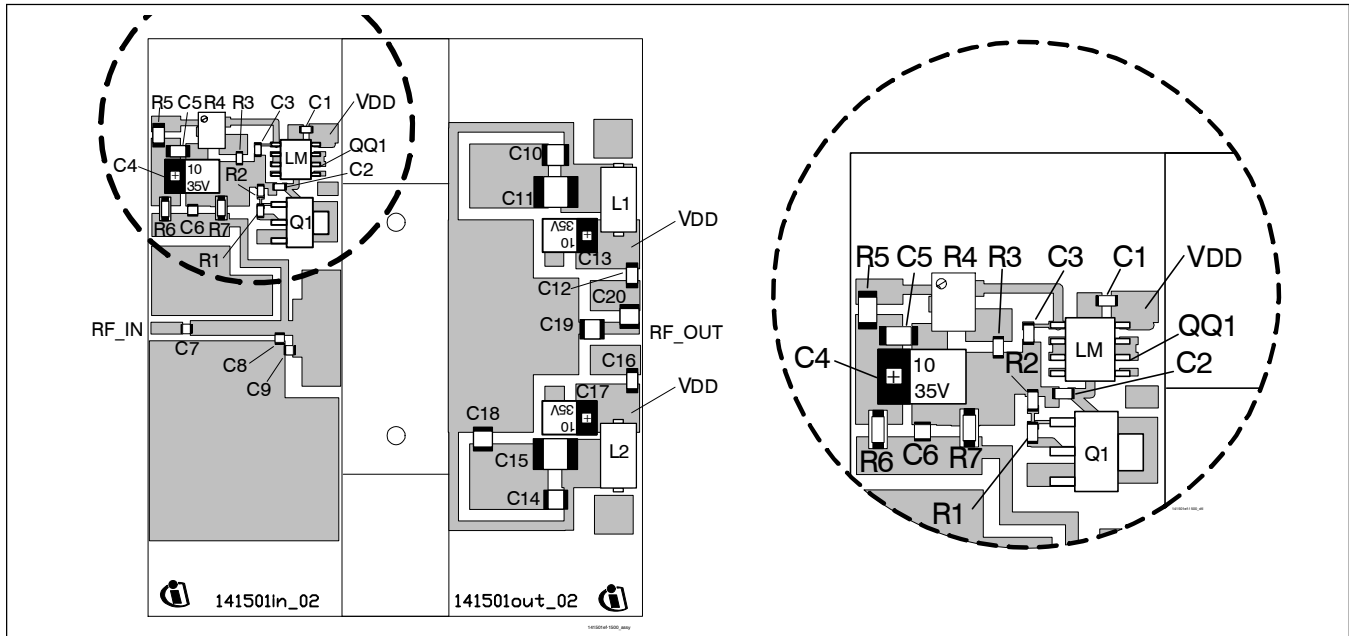

Reference circuit (not to scale)*

Component	Description	Suggested Manufacturer	P/N or Comment
C1, C2, C3	Capacitor, 0.001 μ F, 50 V, 0603	Digi-Key	PCC1772CT-ND
C4, C13, C17	Capacitor, 10 μ F, 35 V, SMD	Digi-Key	PCS6106TR-ND, Tant. TE Series
C5, C12, C16	Capacitor, 0.1 μ F, 50 V, 1206	Digi-Key	P4525-ND
C6	Capacitor, 7.5 pF	ATC	100A 7R5
C7	Capacitor, 33 pF	ATC	100A 330
C8	Capacitor, 0.3 pF	ATC	100A 0R3
C9	Capacitor, 2.4 pF	ATC	100A 2R4
C10, C14	Capacitor, 13 pF	ATC	100B 130
C11, C15	Capacitor, 1 μ F, 50 V	Digi-Key	19528-ND
C18	Capacitor, 0.7 pF	ATC	100B 0R7
C19	Capacitor, 33 pF	ATC	100B 330
C20	Capacitor, 0.3 pF	ATC	100B 0R3
L1, L2	Ferrite, 6 mm	Philips	53/3/4.6-452
Q1	Transistor	Infineon	BCP56
QQ1	Voltage regulator	Digi-Key	LM7805
R1	Resistor, 1.2 k-ohms, 1/10 W, 0603	Digi-Key	P1.2KGCT-ND
R2	Resistor, 1.3 k-ohms, 1/10 W, 0603	Digi-Key	P1.3KGCT-ND
R3	Resistor, 2 k-ohms, 1/10 W, 0603	Digi-Key	P2KGCT-ND
R4	Potentiometer, 2 k-ohms, 0.25 W	Digi-Key	3224W-202ETR-ND
R5, R7	Resistor, 5.1 k-ohms, 1/4 W, 1206	Digi-Key	P5.1KECT-ND
R6	Resistor, 10 ohms, 1/4 W, 1206	Digi-Key	P10ECT-ND

*Gerber files for this circuit are available on request.

Alternate Application for 1600 MHz

Typical Performance

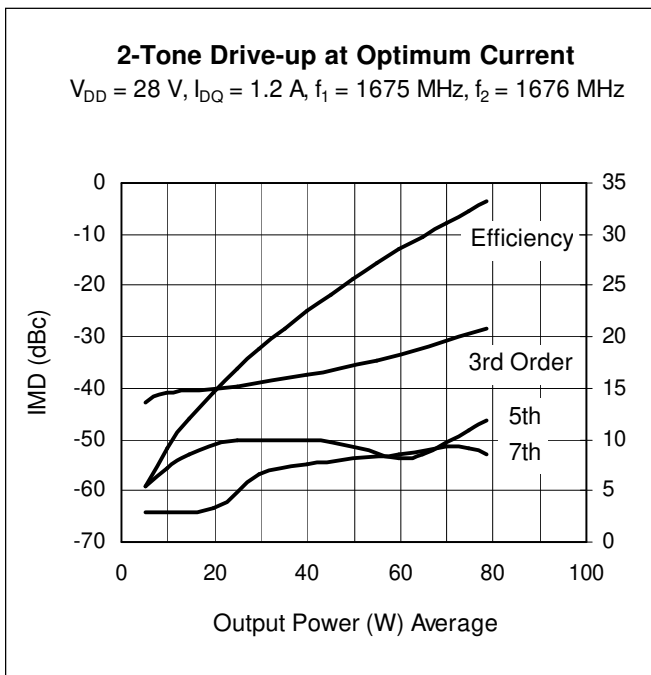
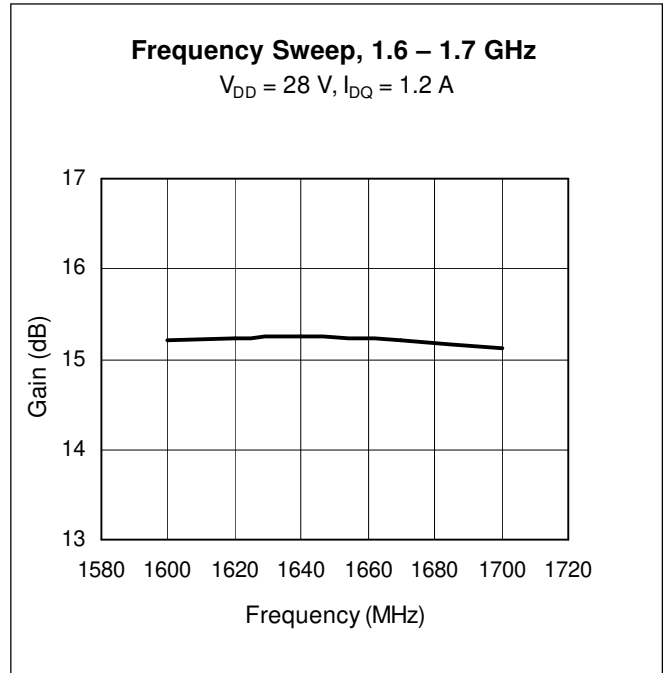
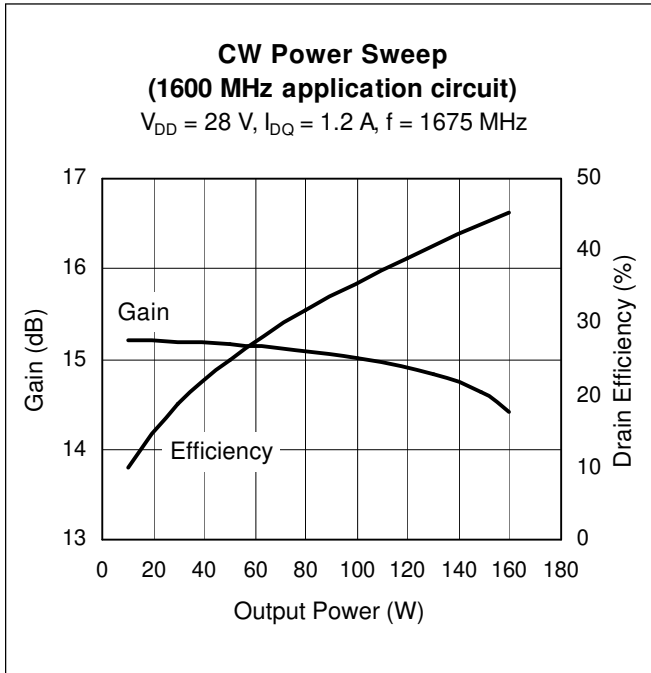

Broadband Circuit Impedance, 1600 MHz

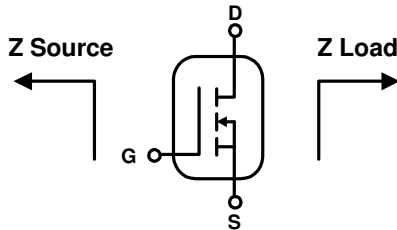

Frequency MHz	Z Source Ω		Z Load Ω	
	R	jX	R	jX
1600	9.5	-5.6	0.9	-5.8
1625	9.6	-5.2	0.8	-5.4
1650	9.8	-5.0	0.8	-5.2
1675	9.9	-4.7	0.8	-5.0
1700	10.0	-4.4	0.8	-4.8

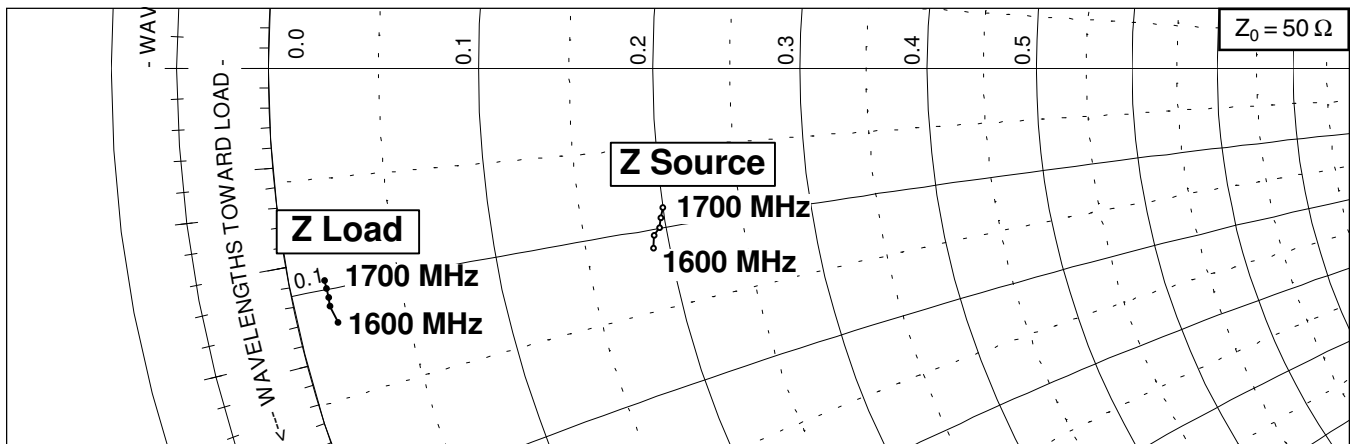

See next page for alternate Reference Circuit, 1600 MHz

Reference Circuit for 1600 MHz

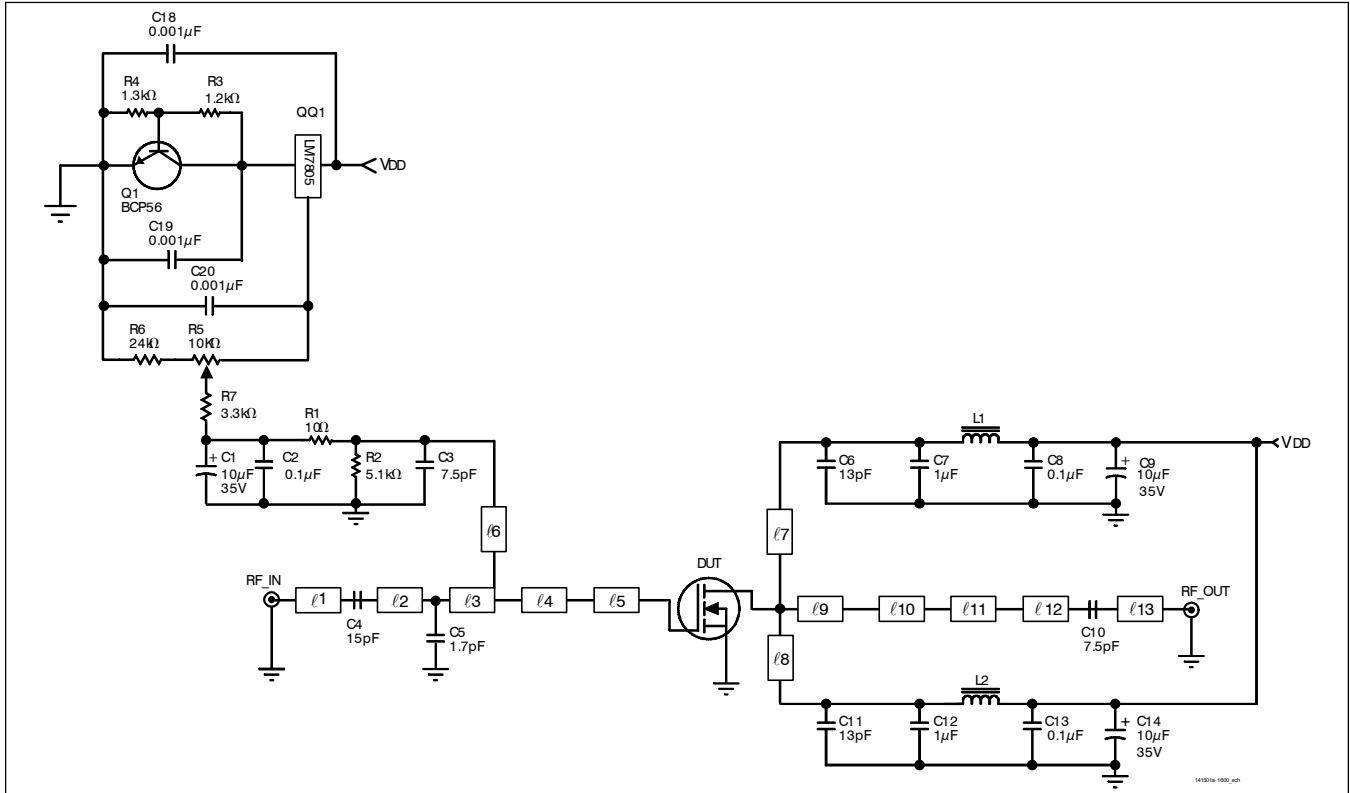

Reference Circuit Schematic for 1600 MHz

Circuit Assembly Information

DUT	PTF141501E	LDMOS Transistor
PCB	0.76 mm [0.030"] thick, $\epsilon_r = 4.5$	TMM4 2 oz. copper, both sides

Microstrip	Electrical Characteristics ¹ at 1500 MHz	Dimensions: L x W (mm)	Dimensions: L x W (in.)
l1	0.043 λ , 50.0 Ω	4.67 x 1.47	0.185 x 0.058
l2	0.065 λ , 42.0 Ω	6.73 x 1.85	0.265 x 0.073
l3	0.065 λ , 42.0 Ω	6.73 x 1.85	0.265 x 0.073
l4	0.012 λ , 14.7 Ω	1.22 x 7.57	0.048 x 0.298
l5	0.052 λ , 8.0 Ω	5.08 x 15.19	0.200 x 0.598
l6	0.182 λ , 60.0 Ω	20.17 x 0.97	0.794 x 0.038
l7	0.283 λ , 63.0 Ω	31.45 x 0.89	1.238 x 0.035
l8	0.283 λ , 63.0 Ω	31.45 x 0.89	1.238 x 0.035
l9	0.112 λ , 4.6 Ω	10.67 x 27.89	0.420 x 1.098
l10	0.016 λ , 9.4 Ω	1.52 x 27.89	0.060 x 0.497
l11	0.053 λ , 34.0 Ω	5.72 x 12.62	0.225 x 0.100
l12	0.011 λ , 50.0 Ω	1.14 x 1.47	0.045 x 0.058
l13	0.066 λ , 50.0 Ω	7.17 x 1.47	0.282 x 0.058

¹Electrical Characteristics are rounded.

Reference Circuit for 1600 MHz (cont.)

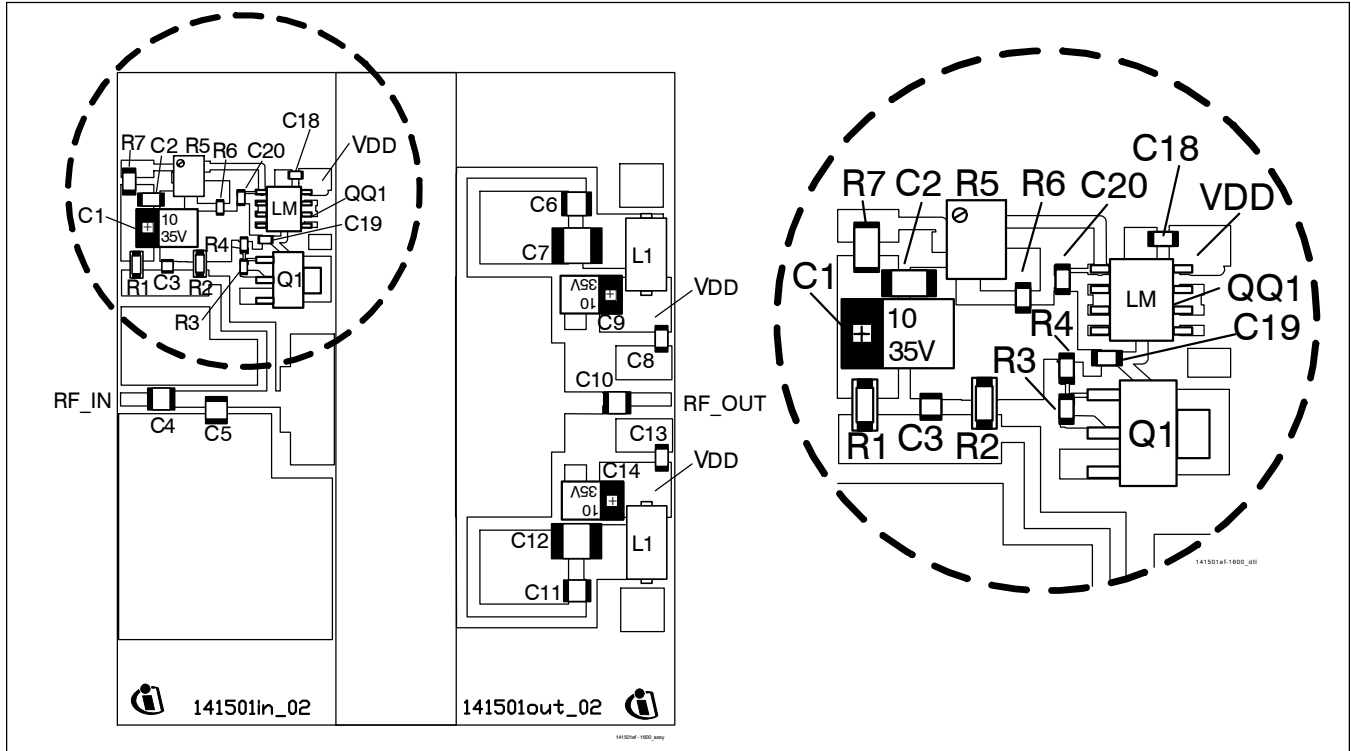

Reference circuit for 1600 MHz* (not to scale)

Component	Description	Suggested Manufacturer	P/N or Comment
C1, C9, C14	Capacitor, 10 μ F, 35 V, Tant. TE Series	Digi-Key	PCS6106TR-ND, SMD
C2, C8, C13	Capacitor, 0.1 μ F, 50 V, 1206	Digi-Key	P4525-ND
C3	Capacitor, 7.5 pF	ATC	100A 7R5
C4	Capacitor, 15 pF	ATC	100B 150
C10	Capacitor, 7.5 pF	ATC	100B 7R5
C5	Capacitor, 1.7 pF	ATC	100B 1R7
C6, C11	Capacitor, 13 pF	ATC	100B 130
C7, C12	Capacitor, 1 μ F, 50 V	Digi-Key	19528-ND
C18, C19, C20	Capacitor, 0.001 μ F, 50 V, 0603	Digi-Key	PCC1772CT-ND
L1, L2	Ferrite, 6 mm	Philips	53/3/4.6-452
Q1	Transistor	Infineon	BCP56
QQ1	Voltage regulator	Digi-Key	LM7805
R1	Resistor, 10 ohms, 1/4W, 1206	Digi-Key	P10ECT-ND
R2	Resistor, 5.1 k-ohms, 1/4W, 1206	Digi-Key	P5.1KECT-ND
R3	Resistor, 1.2 k-ohms, 1/10W, 0603	Digi-Key	P1.2KGCT-ND
R4	Resistor, 1.3 k-ohms, 1/10W, 0603	Digi-Key	P1.3KGCT-ND
R5	Potentiometer, 10 k-ohms, 0.25W	Digi-Key	3224W-103ETR-ND
R6	Resistor, 24 k-ohms, 1/10W, 0603	Digi-Key	P24KGCT-ND
R7	Resistor, 3.3 k-ohms, 1/4W, 1206	Digi-Key	P3.3KECT-ND

*Gerber files for this circuit are available on request.

Package Outline Specifications

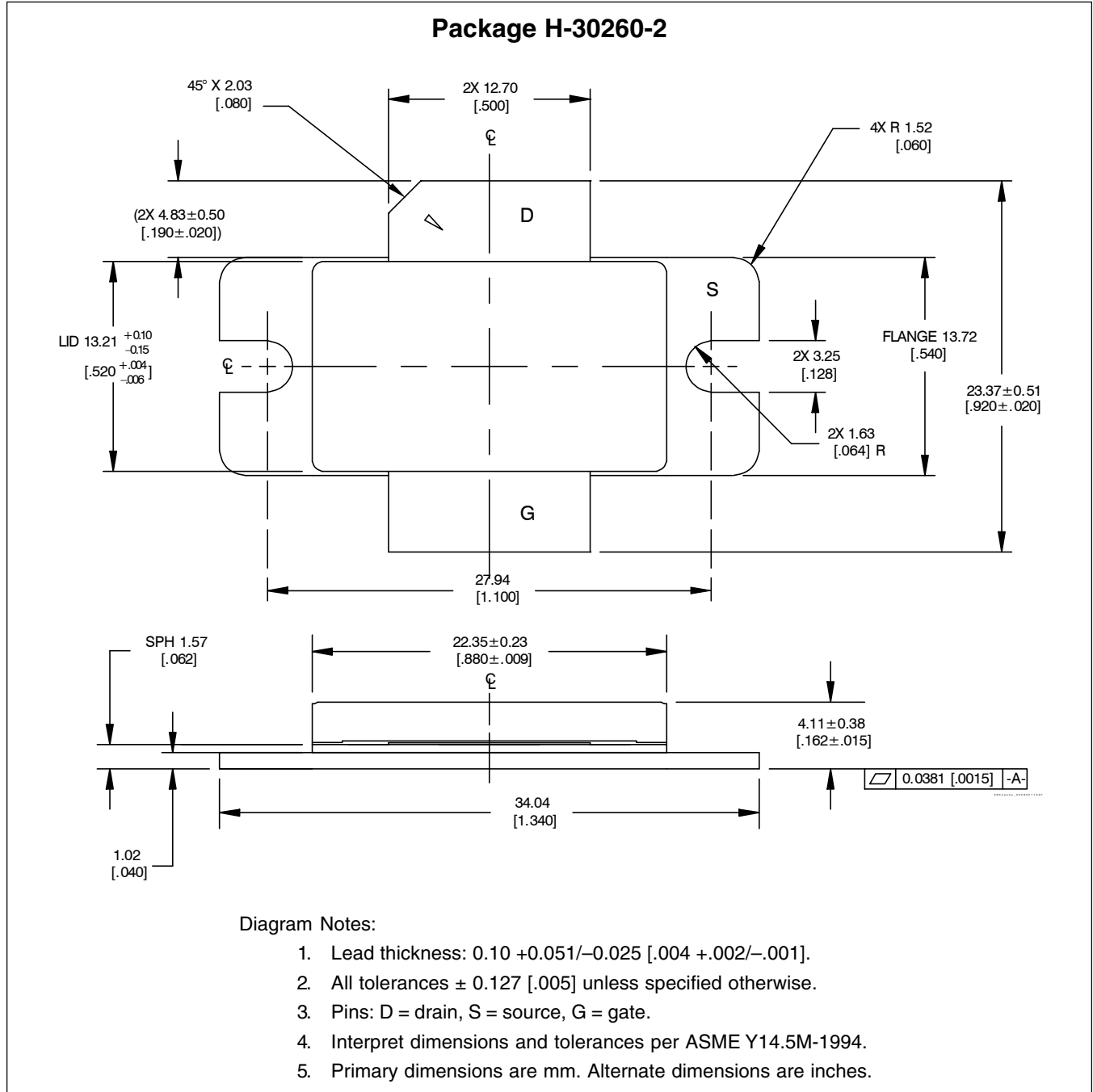

Find the latest and most complete information about products and packaging at the Infineon Internet page <http://www.infineon.com/rfpower>

Revision History: 2008-02-13 Data Sheet

Previous Version: 2005-08-30, Data Sheet

Page	Subjects (major changes since last revision)
All	Remove references to alternate products.

We Listen to Your Comments

Any information within this document that you feel is wrong, unclear or missing at all? Your feedback will help us to continuously improve the quality of this document.

Please send your proposal (including a reference to this document) to:

highpowerRF@infineon.com

To request other information, contact us at:
+1 877 465 3667 (1-877-GO-LDMOS) USA
or +1 408 776 0600 International

GOLDMOS[®] is a registered trademark of Infineon Technologies AG.

Edition 2008-02-13

**Published by
Infineon Technologies AG
81726 Munich, Germany**

**© 2003 Infineon Technologies AG
All Rights Reserved.**

Legal Disclaimer

The information given in this document shall in no event be regarded as a guarantee of conditions or characteristics. With respect to any examples or hints given herein, any typical values stated herein and/or any information regarding the application of the device, Infineon Technologies hereby disclaims any and all warranties and liabilities of any kind, including without limitation, warranties of non-infringement of intellectual property rights of any third party.

Information

For further information on technology, delivery terms and conditions and prices, please contact the nearest Infineon Technologies Office (www.infineon.com/rfpower).

Warnings

Due to technical requirements, components may contain dangerous substances. For information on the types in question, please contact the nearest Infineon Technologies Office.

Infineon Technologies components may be used in life-support devices or systems only with the express written approval of Infineon Technologies, if a failure of such components can reasonably be expected to cause the failure of that life-support device or system or to affect the safety or effectiveness of that device or system. Life support devices or systems are intended to be implanted in the human body or to support and/or maintain and sustain and/or protect human life. If they fail, it is reasonable to assume that the health of the user or other persons may be endangered.