

46202LRX

SCHEMATIC
SINGLE POLE SINGLE THROW

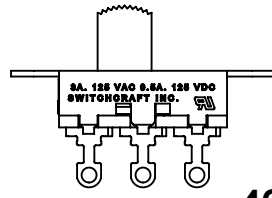

46203LRX

SCHEMATIC
SINGLE POLE DOUBLE THROW

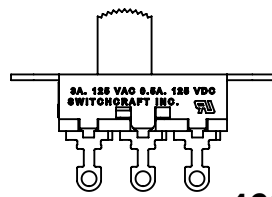

46203LSRX

SCHEMATIC
SINGLE POLE DOUBLE THROW
SHORTING CONTACT

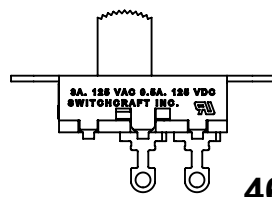

46204LRX

SCHEMATIC
DOUBLE POLE SINGLE THROW

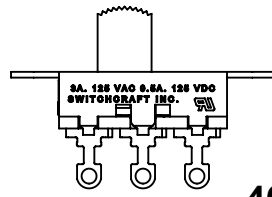

46206LRX

SCHEMATIC
DOUBLE POLE DOUBLE THROW

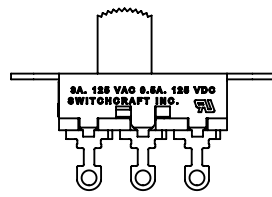

46206LSRX

SCHEMATIC
DOUBLE POLE DOUBLE THROW
SHORTING CONTACTS

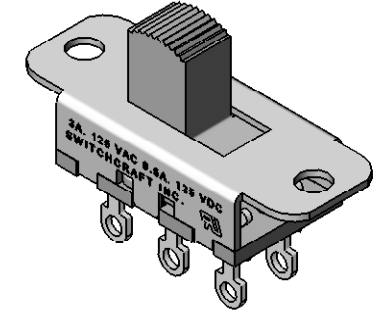
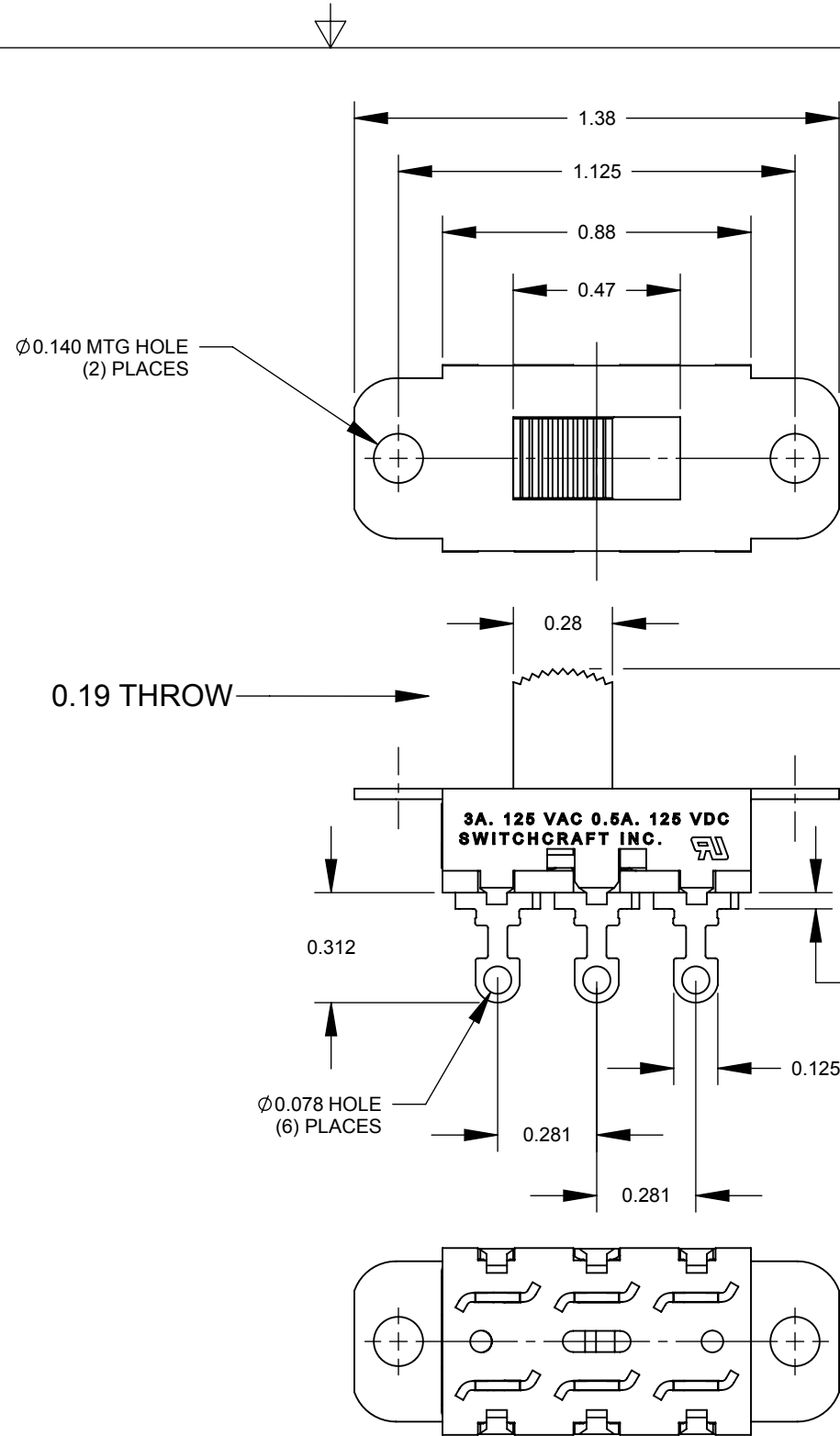

46206LRX SHOWN

CUSTOMER DRAWING

- NOTES:
- ALL DIMENSIONS REFERENCE UNLESS OTHERWISE SPECIFIED.
 - MATERIALS:
HOUSING - STEEL, ZINC PLATED
BUTTON - THERMOPLASTIC, BLACK
TERMINALS & CONTACT SLIDER - BRASS, SILVER PLATED
TERMINAL BOARD - PHENOLIC
 - SWITCH RATING:
3 AMP, 125 V.A.C., 0.5 AMP, 125 V.D.C.
 - THIS PRODUCT IS RoHS COMPLIANT.

REV	ECO NUMBER	DATE	BY	APVD
A	26008	8/5/06	RS	TJK
REVISIONS				

UNLESS OTHERWISE SPECIFIED

1. ALL DIMENSIONS IN INCHES
- TWO PLACE DECIMALS ±0.02
- THREE PLACE DECIMALS ±0.005

DO NOT SCALE DRAWING

THIS DRAWING DESCRIBES A DESIGN CONSIDERED PROPRIETARY IN NATURE, DEVELOPED AND MANUFACTURED BY SWITCHCRAFT INC. AND IS RELEASED ON A CONFIDENTIAL BASIS FOR IDENTIFICATION PURPOSES ONLY.									
SIZE	WIDTH	MULT	LBS/M	TEMPER					
FINISH					MATERIAL				
SPEC No.					SPEC No.				
FIRST USED ON					SCALE				
					2:1				
DATE DRAWN	BY	CHKD	APVD						
2/19/09	RS	RS	TJK						
					2/19/09				
					2/19/09				
NAME					PART No.				
46200LR SERIES					46200LRX SERIES				
SLIDE SWITCH, RoHS					REV				
					A				